

MCDP28x0 DisplayPort1.2a to HDMI2.0 Level Shifter/Protocol Converter [LSPCON]

Datasheet

Rev B



MegaChips' Proprietary Information

MegaChips reserves the right to make any change herein at any time without prior notice. MegaChips does not assume any responsibility or liability arising out of application or use of any product or service described herein except as explicitly agreed upon.

Features

- DisplayPort® (DP) ver. 1.2a receiver
 - Link rate HBR2/HBR/RBR
 - 1, 2, or 4 lanes configuration
 - AUX CH 1 Mbps, HPD out
 - Supports eDP ASSR scrambler operation
- HDMI ver. 2.0 transmitter
 - Max data rate up to 6.0 Gbps/ch
 - Deep color up to 16 bits per color
 - 3D video timings, CEC, HPD in
 - Supports High Dynamic Range (HDR)
 - Supports scrambling for the higher data rate
- Level shifter operation (up to 3.4Gbps/ch)
 - AC-coupled HDMI1.4b to DC-coupled HDMI1.4b
 - PHY analog repeater (re-driver or re-timer)
 - 3.3 V DDC/AUX CH signaling support with auto detect
 - 3.3 V DDC to 5V DDC buffering
 - I2C-over-AUX to 5V DDC translation
 - DP HPD_OUT matched to HDMI HPD_IN
- Protocol converter operation (up to 6.0 Gbps/ch)
 - DP SST-to-HDMI format conversion
 - Video and audio forwarding
 - Pixel encoding format conversion from YCbCr444 to YCbCr420
 - Horizontal expansion of VESA CVT to CEA-861 timings
 - Meta data handing
- Level shifter – Protocol converter mode switching
 - Via sideband communication (AUX CH/ DDC)
- Max video resolution and color depth
 - 4Kp60Hz, RGB/YCbCr444, 8bpc
 - 4Kp60Hz, YCbCr420, up to 16bpc
 - 4Kp30Hz, RGB/YCbCr444, up to 16bpc
- YCbCr420 support
 - YCbCr444-to-420 conversion, up to 16 bpc
 - YCbCr420 pass through, up to 16 bpc
- Stereoscopic 3D forwarding
 - Conversion from frame sequential over DP to stacked top-bottom 3D over HDMI
- All other 3D formats forwarded as is
- Audio forwarding
 - 2-ch, 768 kHz 24bps HBR audio
 - Up to 8-ch, 192 kHz, 24bps LPCM audio, AC3, DTS
- Secure communication
 - Intel secure communication protocol compliant with LSPCON spec
- HDCP content protection
 - Embedded HDCP keys
 - HDCP2.2 transmitter
 - HDCP1.x repeater
- Metadata handling
 - HDMI TX DVI/HDMI mode setting (DPCD register)
 - YCbCr444-420 conversion (DPCD register)
 - IEC60958 BYTE3 channel status overwrite
 - CEA861F INFOFRAME generation
 - CEA861-3 HDR and Mastering InfoFrame
- SCDC read request handling
 - Polling enabled for HDMI sinks not supporting read request
- AUX to I2C bridge for EDID/MCCS pass through
- CEC tunneling over AUX CH
- Device configuration options
 - SPI flash for firmware binary image storage required
 - AUX CH, I2C host interface (optional)
- EMI reduction support
 - Spread spectrum for DP input
 - Scrambler for DP input and HDMI2.0a output
- Low power operation
 - 412 mW in protocol converter mode
 - 100 mW in Level shifter mode
 - 0.1 mW in connected standby mode
- ESD specification
 - +/-6.5 KV HBM, 500 V CDM
- Package
 - 64 LFBGA (7 x 7 mm)
- Power supply voltages
 - 3.3 V I/O; 1.2 V core

Applications

- PC notebook/ tablet motherboard
- DP/USB Type-C docking station, dongle

Figure 1. MCDP28x0 internal block diagram

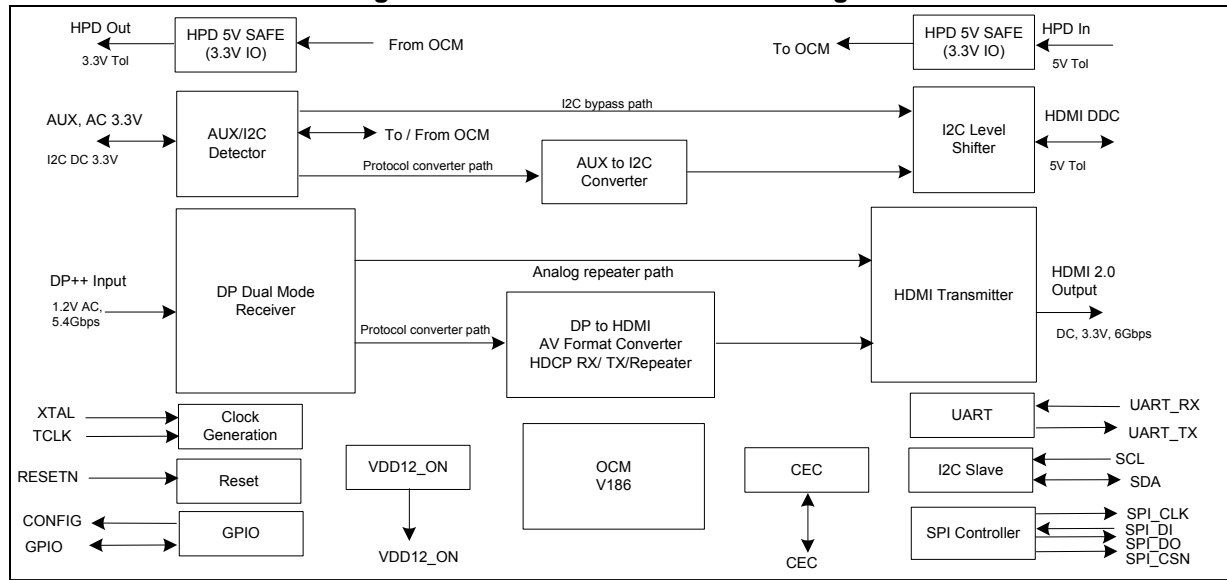

Contents

1.	Description	7
2.	Application overview	9
2.1	Motherboard-down topology	9
2.2	Adaptor topology	9
3.	BGA footprint and pin lists	11
3.1	Ball grid array diagram	11
3.2	Signal mapping sorted by ball (pin) number	12
4.	Connections	14
4.1	Pin list	14
4.2	Bootstrap configuration	18
4.3	RESETN connection	19
5.	Package specifications	20
5.1	Package drawing	20
5.2	LFBGA 7 x 7 dimensions	21
5.3	Marking field template and descriptors	21
5.4	Classification reflow profile	22
6.	Electrical specifications	23
6.1	Absolute maximum ratings	23
6.2	Power Connections	24
6.3	DC characteristics	25
6.4	AC characteristics	26
6.4.1	DisplayPort receiver	27
6.4.2	HDMI transmitter I/O specifications	28
6.4.3	I2C interface timing	29
6.4.4	SPI interface timing	30
7.	Ordering information	31
8.	Revision history	32

List of Tables

Table 1.	Pin list	12
Table 2.	DisplayPort receiver pins	14
Table 3.	HDMI output pins	15
Table 4.	System interface pins	16
Table 5.	Power and ground pins	18
Table 6.	Bootstrap configuration	18
Table 7.	Field descriptors	22
Table 8.	Absolute maximum ratings	23
Table 9.	DC characteristics	25
Table 10.	IO DC characteristics	25
Table 11.	Maximum speed of operation	26
Table 12.	DisplayPort receiver characteristics	27
Table 13.	HDMI transmitter I/O specifications	28
Table 14.	HDMI transmitter AC characteristics	28
Table 15.	I2C interface timing	29
Table 16.	SPI interface timing, VDD = 3.3 V	30
Table 17.	Order codes	31
Table 18.	Document revision history	32

List of Figures

Figure 1.	MCDP28x0 internal block diagram	3
Figure 2.	MCDP2800 motherboard-down use case	9
Figure 3.	MCDP2850 adaptor (dongle) use case	10
Figure 4.	MCDP28x0 BGA diagram	11
Figure 5.	RESETN Connection to MCDP28x0	19
Figure 6.	MCDP28x0 package drawing	20
Figure 7.	MCDP28x0 package dimensions	21
Figure 8.	Marking template	22
Figure 9.	I2C timing	29

1. Description

The MCDP28x0 is a power-optimized DisplayPort1.2a-to-HDMI 2.0 converter device targeted for desktop/mobile PC motherboard-down applications and for DP or USB type-C adaptor (dongle, docking station) applications. This device functions as a level shifter as well as an active protocol converter.

In level shifter mode, the device functions as a PHY repeater with optional jitter removal capability. This operating mode provides a low-power means of using an AC-coupled TMDS signal from a dual mode DP (DP++) source to be repeated to the HDMI output. The maximum TMDS character clock frequency in this mode is limited to 340 Mchar/s (per HDMI1.4b specification).

In Protocol Converter (PCON) mode, MCDP28x0 functions as a DP branch device receiving AC coupled DisplayPort stream and converting it to HDMI output. The maximum TMDS character clock frequency supported in this mode is up to 600 Mchar/s (as per the HDMI2.0a specification).

The MCDP28x0 operates with two power supply voltages: 1.2 V and 3.3 V. It consumes:

- 100 mW in PHY analog repeater mode
- 412 mW in protocol converter mode
- 0.1 mW in connected standby mode (1.2 V power rail disabled)

The MCDP28x0 has a DisplayPort1.2a dual-mode receiver and HDMI 2.0a transmitter. The upstream main link can receive DP input at HBR2 rate over 4 lanes and AC-coupled TMDS signal up to 340Mchar/s. It supports DP SST stream on its main link and Manchester-coded AUX signaling or native 3.3 I2C signaling as the side band channel with the DP++ source. The downstream HDMI TX port is HDMI 2.0 specification compliant.

The MCDP28x0 is capable of supporting Ultra High-Definition video formats, resolutions as high as 4096 x 2160@60 Hz. It supports RGB/YCbCr video color formats with a color depth of 16 bpc (or 48 bits per pixel) as long as it fits within the DP1.2 and HDMI2.0a link rate. In addition, this device also supports pixel encoding conversion from YCbCr444 to YCbCr420 and YcbCr420 pass-through from a DP input to an HDMI output. High Dynamic Range (HDR) with deep color up to 12bpc at 4Kp60Hz is supported through the conversion of YCbCr444 CVT timing over DP link with horizontal expansion to YCbCr420 CEA timing on the HDMI TX output.

This device offers secure reception and transmission of high bandwidth digital audio and video content with HDCP 1.x content protection for the upstream DP interface and HDCP2.2 for the downstream HDMI interface. It also operates as an HDCP1.x repeater between the source and the sink. In addition, it conforms to the secure communication protocol specified in the Intel "LSPCON Security Requirements

Architecture Specification” document. The MCDP28x0 comes with embedded HDCP keys that are stored in encrypted form.

The MCDP28x0 uses an external crystal of 27 MHz as a reference clock for its operation and it has a reset input which provides the chip reset during system power up. The device has an on-chip microcontroller with SPI, UART, and I2C interfaces for system level communication and debug. It requires an external SPI flash memory for storing device configuration firmware. The firmware update is done through the DP AUX channel or through UART interface. An 8 Mbit SPI flash memory is recommended for storing the firmware with a backup option as fail-safe during in-system-programming.

2. Application overview

Two important target applications of MCDP28x0 are:

- Mobile PC motherboard application. This is referred as motherboard-down topology and the part number that supports this topology is MCDP2800.
- Accessory application (dongle, docking station etc.). This is referred as adaptor topology and the part number for this topology is MCDP2850.

2.1 Motherboard-down topology

In a Motherboard-down topology, the MCDP2800 resides next to the source (CPU/GPU) device on a same PCB with relatively short copper tracks connecting directly to the source. These tracks are typically micro stripes with controlled impedance of 100 Ω . In this configuration, the source device is aware of the presence and capabilities of the MCDP2800. The source communicates with MCDP2800 through AUX/DDC interface via I2C-over-AUX or native I2C (3.3V) messaging. In this topology, typically the MCDP2800 operates as a re-driving or re-timing analog repeater for AC-coupled TMDS input for speeds below 3.4Gbps and as a DisplayPort to HDMI protocol converter for speeds above 3.4 Gbps up to 6.0 Gbps. The analog repeater mode saves the active power consumption during low frequency operation. MCDP2800 however is capable of operating as DP to HDMI protocol converter for the entire operating range up to 6 Gbps. The motherboard-down topology supports transmitting both HDCP1.x and HDCP2.2 protected content over the HDMI output.

Figure 2. MCDP2800 motherboard-down use case

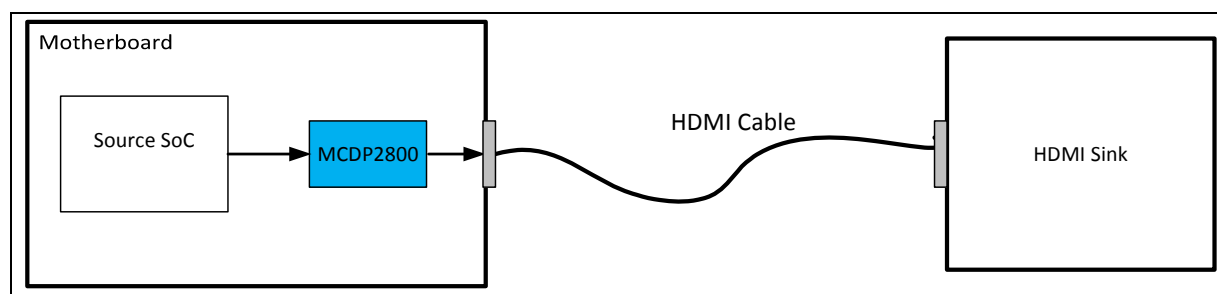

2.2 Adaptor topology

In an adaptor topology, the MCDP2850 is part of the source side adaptor or docking station that plugs into the PC/NB via a DP++ connector. In this case, a typical source sends out a DP signal to the adaptor and the adaptor converts it into HDMI 2.0 output for the entire operating frequency range. However, a source which is aware of the presence and capabilities of the MCDP2850 can choose to send an AC-

coupled TMDs signal at lower speeds (below 3.4 Gbps) and a DP signal at higher speeds (above 3.4 Gbps) similar to a motherboard-down topology. In the adaptor application, the MCDP2850 dynamically decides whether to use I2C-over-AUX or native I2C messaging at the time of connectivity with the source. MCDP2850 only supports HDCP1.x repeater/transmitter functionality; no HDCP2.2 transmitter function allowed in this topology.

Note: In an adaptor topology, signal degradation is higher compared to in a motherboard-down topology due to longer traces and multiple connectors in the path.

Figure 3. MCDP2850 adaptor (dongle) use case

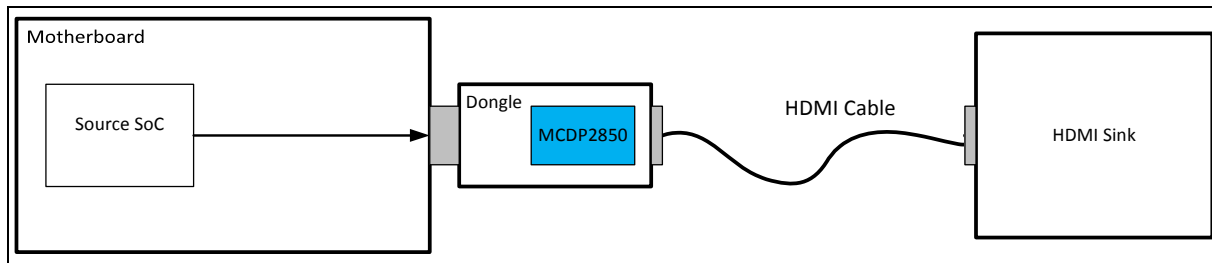

3. BGA footprint and pin lists

3.1 Ball grid array diagram

The ball grid array (BGA) diagrams give the allocation of signals to the balls of the package, shown from the top looking down using the PCB footprint.

Some signal names in BGA diagrams have been abbreviated. Refer to the pin list for full signal names sorted by pin number.

Figure 4. MCDP28x0 BGA diagram

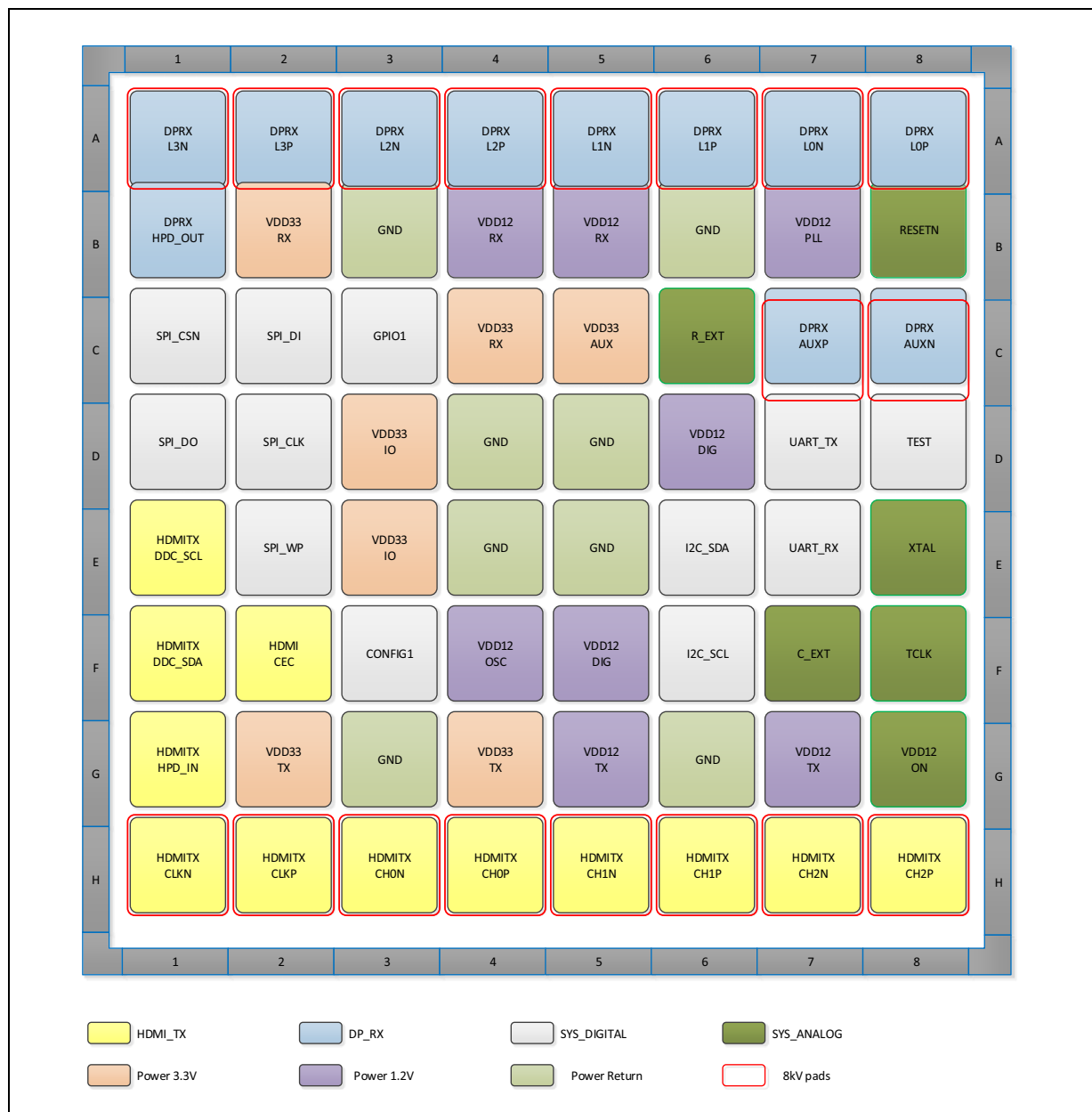

3.2 Signal mapping sorted by ball (pin) number

Table 1. Pin list

Pin number	Net name
A1	DPRX_L3N
A2	DPRX_L3P
A3	DPRX_L2N
A4	DPRX_L2P
A5	DPRX_L1N
A6	DPRX_L1P
A7	DPRX_L0N
A8	DPRX_L0P
B1	DPRX_HPD_OUT
B2	VDD33_RX
B3	GND
B4	VDD12_RX
B5	VDD12_RX
B6	GND
B7	VDD12_PLL
B8	RESETN
C1	SPI_CSN
C2	SPI_DI
C3	GPIO1
C4	VDD33_RX
C5	VDD33_AUX
C6	R_EXT
C7	DPRX_AUXP
C8	DPRX_AUXN
D1	SPI_DO
D2	SPI_CLK
D3	VDD33_IO
D4	GND
D5	GND
D6	VDD12_DIG
D7	UART_TX
D8	TEST
E1	HDMITX_DDC_SCL
E2	SPI_WP

Table 1. Pin list (continued)

Pin number	Net name
E3	VDD33_IO
E4	GND
E5	GND
E6	I2C_SDA
E7	UART_RX
E8	XTAL
F1	HDMITX_DDC_SDA
F2	HDMI_CEC
F3	CONFIG1
F4	VDD12_OSC
F5	VDD12_DIG
F6	I2C_SCL
F7	C_EXT
F8	TCLK
G1	HDMITX_HPD_IN
G2	VDD33_TX
G3	GND
G4	VDD33_TX
G5	VDD12_TX
G6	GND
G7	VDD12_TX
G8	VDD12_ON
H1	HDMITX_CLKN
H2	HDMITX_CLKP
H3	HDMITX_CH0N
H4	HDMITX_CH0P
H5	HDMITX_CH1N
H6	HDMITX_CH1P
H7	HDMITX_CH2N
H8	HDMITX_CH2P

4. Connections

4.1 Pin list

I/O Legend:

I = Input; O = Output; P = Power; G = Ground; IO = Bi-direction; AI = Analog input

Table 2. DisplayPort receiver pins

Pin	Assignment	I/O	VDD Domain	Description
A1	DPRX_L3N	I	1.2 V	DisplayPort receiver main link Lane 3 negative analog input. AC-coupled internal pull up to VDD12_RX through 50 Ω resistor.
A2	DPRX_L3P	I	1.2 V	DisplayPort receiver main link Lane 3 positive analog input. AC-coupled internal pull up to VDD12_RX through 50 Ω resistor.
A3	DPRX_L2N	I	1.2 V	DisplayPort receiver main link Lane 2 negative analog input. AC-coupled internal pull up to VDD12_RX through 50 Ω resistor.
A4	DPRX_L2P	I	1.2 V	DisplayPort receiver main link Lane 2 positive analog input. AC-coupled internal pull up to VDD12_RX through 50 Ω resistor.
A5	DPRX_L1N	I	1.2 V	DisplayPort receiver main link Lane 1 negative analog input. AC-coupled internal pull up to VDD12_RX through 50 Ω resistor.
A6	DPRX_L1P	I	1.2 V	DisplayPort receiver main link Lane 1 positive analog input. AC-coupled internal pull up to VDD12_RX through 50 Ω resistor.
A7	DPRX_L0N	I	1.2 V	DisplayPort receiver main link Lane 0 negative analog input. AC-coupled internal pull up to VDD12_RX through 50 Ω resistor.
A8	DPRX_L0P	I	1.2 V	DisplayPort receiver main link Lane 0 positive analog input. AC-coupled internal pull up to VDD12_RX through 50 Ω resistor.

Pin	Assignment	I/O	VDD Domain	Description
C7	DPRX_AUXP	IO	3.3 V	DisplayPort receiver auxiliary channel positive analog input/output. Common mode voltage = 3.3 V AC-coupled internal pull up to VDD33_AUX through 50 Ω resistor. Also functions as DDC_SCL.
C8	DPRX_AUXN	IO	3.3V	DisplayPort receiver auxiliary channel negative analog input/output. Common mode voltage = 3.3 V AC-coupled internal pull up to VDD33_AUX through 50 Ω resistor. Also functions as DDC_SDA.
B1	DPRX_HPD_OUT	O	3.3 V	To the upstream HPD signal pin (DP source), to be externally pulled down (100K ohm recommended) as per DP1.2a spec.
C6	R_EXT	IO	1.2 V	Termination calibration reference resistor; 249 Ω 1% resistor should be connected from this pin to VDD12_RX (1.2 V analog power supply).
F3	CONFIG1	IO	3.3V	General purpose IO. Connects to DP upstream connector pin 13 in Adaptor topology. Optional in Motherboard-down topology. Default POR state is INPUT use weak pull-down when not used.

Table 3. HDMI output pins

Pin	Assignment	I/O	VDD Domain	Description
H1	HDMITX_CLKN	O	3.3 V	HDMI transmitter CLOCK_N to TX connector
H2	HDMITX_CLKP	O	3.3 V	HDMI transmitter CLOCK_P to TX connector
H3	HDMITX_CH0N	O	3.3 V	HDMI transmitter DATA0_N to TX connector
H4	HDMITX_CH0P	O	3.3 V	HDMI transmitter DATA0_P to TX connector
H5	HDMITX_CH1N	O	3.3 V	HDMI transmitter DATA1_N to TX connector
H6	HDMITX_CH1P	O	3.3 V	HDMI transmitter DATA1_P to TX connector
H7	HDMITX_CH2N	O	3.3 V	HDMI transmitter DATA2_N to TX connector
H8	HDMITX_CH2P	O	3.3 V	HDMI transmitter DATA2_P to TX connector

Pin	Assignment	I/O	VDD Domain	Description
E1	HDMITX_DDC_SCL	O	3.3 V, 5 V Tol	HDMI TX DDC I2C master SCL. 3.3 V logic level, 5 V tolerant. Open drain, external 2.2 K pull up to +5 V.
F1	HDMITX_DDC_SDA	IO	3.3 V, 5 V Tol	HDMI TX DDC I2C master SDA. 3.3 V logic level, 5 V tolerant. Open drain, external 2.2 K pull up to +5 V.
F2	HDMI_CEC	IO	3.3 V	CEC input. 3.3 V open drain IO. Connect to HDMI CEC pin, to be externally pulled up to 3.3 V (27K Ohm recommended) as per HDMI1.4b spec.
G1	HDMITX_HPD_IN	I	3.3 V, 5 V Tol	3.3 V logic level, 5 V tolerant input from HDMI connector. To be externally pulled down via resistor. (47K Ohm recommended)

Table 4. System interface pins

Pin	Assignment	I/O	VDD Domain	Reset State	Description
B8	RESETN	I	3.3 V	Input	Power-ON chip reset (active low) input signal Connects to 3.3V VDD through 2.2K +/-10% resistor
E8	XTAL	IO	1.2 V	NA	Connect to 27 MHz crystal oscillator with 22 pF to VDD12_OSC
F8	TCLK	IO	1.2 V	NA	Connect to 27 MHz crystal oscillator with 22 pF to VDD12_OSC
F7	C_EXT	O	3.3V	NA	Capacitor for filtering internal 2.5V LDOR. Connect to GND through 2.2uF capacitor.
G8	VDD12_ON	O	3.3 V	Output	1.2 V power control signal to control external 1.2 V power as shown in Figure 4. Reset State definition assumes 3.3 V Rail is ramped up to full voltage.

Pin	Assignment	I/O	VDD Domain	Reset State	Description
D8	TEST	IO	3.3 V	NA	Test select. Tie to GND for mission mode
E6	I2C_SDA	IO	3.3 V	Input, Internal PU	Host I2C interface data line. External pull-up required for I2C operation. Leave NC when not used.
F6	I2C_SCL	I	3.3 V	Input, Internal PU	Host I2C interface clock line. External pull-up required for I2C operation. Leave NC when not used.
C3	GPIO1	IO	3.3 V	Input, Internal PU	General purpose input/output. Applicable for CONFIG2 if needed. Default POR state is INPUT; use weak pull-down when not used.
C1	SPI_CSN	O	3.3 V	Input, Internal PU	Serial peripheral interface chip select
C2	SPI_DI	I	3.3 V	Input, Internal PD	Serial peripheral interface data input
D1	SPI_DO	O	3.3 V	Input, Internal PD	Serial peripheral interface data output
D2	SPI_CLK	O	3.3 V	Input, Internal PD	Serial peripheral interface clock
E2	SPI_WP	O	3.3 V	Input, Internal PD	Serial peripheral interface write protect
D7	UART_TX	O	3.3 V	Input, Internal PU	Universal asynchronous serial Tx output. Leave NC when not used.

Pin	Assignment	I/O	VDD Domain	Reset State	Description
E7	UART_RX	I	3.3 V	Input, Internal PU	Universal asynchronous serial Rx input. Leave NC when not used.

Table 5. Power and ground pins

Pin	Assignment	Voltage Level	Description
B2, C4	VDD33_RX	L3.3 V	DisplayPort RX analog power
B4, B5	VDD12_RX	1.2 V	DisplayPort RX analog power
C5	VDD33_AUX	3.3 V	DisplayPort AUX analog power
B7	VDD12_PLL	1.2 V	PLL analog power
F4	VDD12_OSC	1,2 V	Oscillator circuit power
G2, G4	VDD33_TX	3.3 V	HDMI TX analog power
G5, G7	VDD12_TX	1.2 V	HDMI TX analog power
D6, F5	VDD12_DIG	1.2 V	Core and 1.2V IO power
D3, E3	VDD33_IO	3.3 V	3.3V IO power
B3, B6, D4, D5, E4, E5, G3, G6	GND	GND	Power return for all supplies

4.2 Bootstrap configuration

Other than the normal operating mode (mission mode), the MCDP28x0 is configured in testing and debugging mode during factory testing and chip bring-up. For this purpose, the chip is configured during the boot operation using several bootstrap configurations. DC levels on these bootstrap pins are latched during the de-asserting edge of power-on reset (RESETN goes HIGH). The levels specified below must be adhered to for the normal function of the device.

Table 6. Bootstrap configuration

Bootstrap signal name	Internal PU/PD	Pin assignment	Function
Bootstrap_0	PULL UP	UART_TX (D7)	0: Reserved for ATE test
			1: Normal operation (mission mode)

Bootstrap_1	PULL DN	SPI_WP (E2)	0: Normal operation (mission mode)
			1: OCM debug mode
Bootstrap_2	PULL DN	SPI_CLK (D2)	0: (Default) Internal ROM is enabled and mapped to top 32 K of OCM memory map. OCM boots from IROM. Normal mode (mission mode).
			1: Internal ROM is disabled. External ROM includes the address range reserved for IROM. OCM boots from EXTROM. Debug mode.
Bootstrap_3	PULL DN	SPI_DO (D1)	0: Default. Reserved (mission mode)
			1: Reserved for testing
Bootstrap_4	PULL UP	SPI_CSN (C1)	0: Select external CLK on XTAL pin (used in ATE).
			1: (Default) Select crystal and internal oscillator. Normal operation (mission mode).

Note: When the pin corresponding to a specific bootstrap is left NC, the pin takes the value of the assigned by the internal PULLUP (Level 1) or PULLDN (Level 0). The internal resistor used is around 50 kΩ. To select a non-default value on a bootstrap, an external PULLUP or PULLDN resistor tied to the opposite direction that overcomes the internal PULLUP or PULLDN needs to be used.

4.3 RESETN connection

The RESETN pin must be pulled up to 3.3 V via a 2.2 kohm +/- 10% resistor as shown below. The chip also supports an active low, external reset pulse to RESETN allowing a system host controller to reset the system. The recommended way to drive RESETN is through an open-drain output. Alternately, if an open-drain output is not available, the series resistor shown in the figure below is required.

Figure 5. RESETN Connection to MCDP28x0

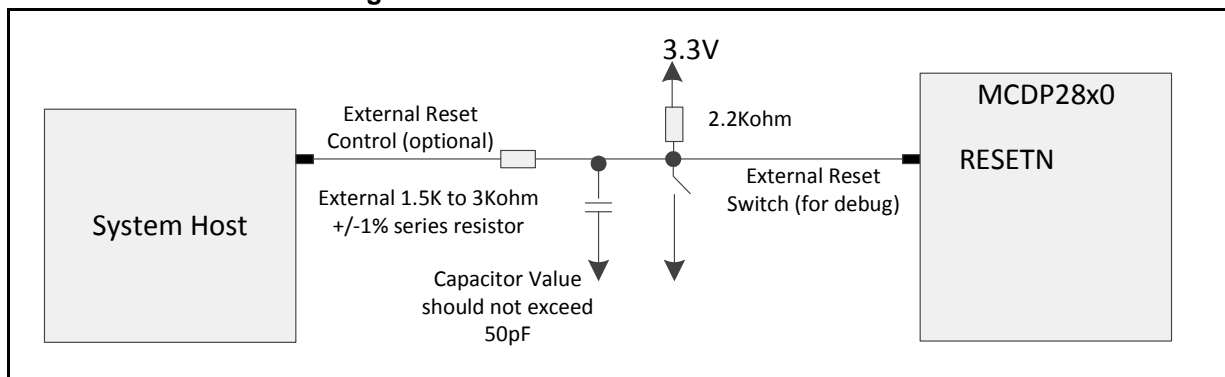

5. Package specifications

Package type: LFBGA (7 x 7 x 1.4 mm, 64 F8 x 8 Pitch 0.8 Ball 0.4)

5.1 Package drawing

Figure 6. MCDP28x0 package drawing

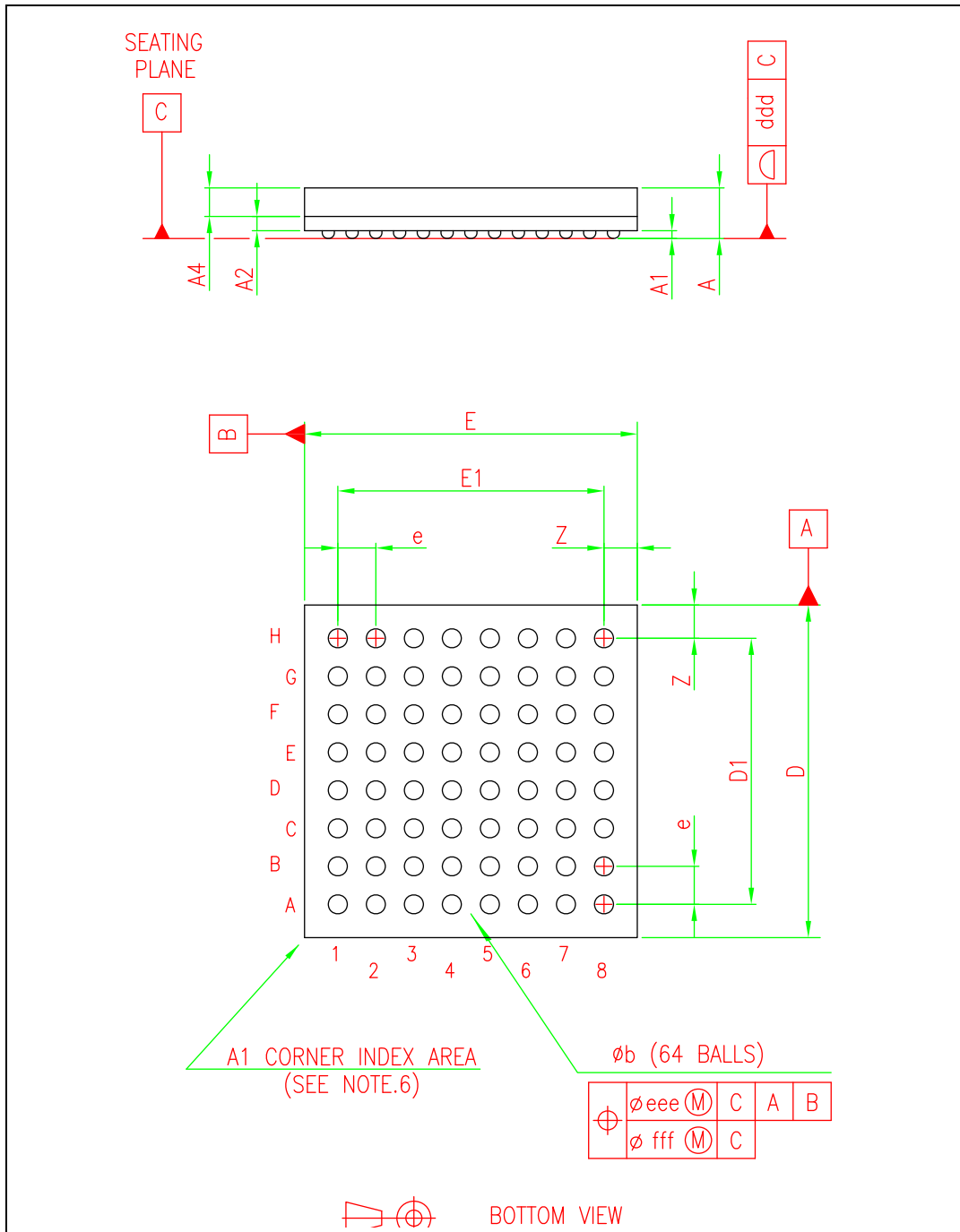

5.2 LFBGA 7 x 7 dimensions

Figure 7. MCDP28x0 package dimensions

DIMENSIONS							
DATABOOK (mm)				DRAWING (mm)			NOTES
REF.	MIN.	TYP.	MAX.	MIN.	TYP.	MAX.	
A			1.4			1.24	(1)
A1	0.25			0.25	0.30	0.35	
A2		0.29		0.24	0.28	0.32	
A4			0.60	0.57	0.585	0.60	
b	0.35	0.40	0.45	0.35	0.40	0.45	(2)
D	6.95	7.00	7.05	6.95	7.00	7.05	
D1		5.60			5.60		
E	6.95	7.00	7.05	6.95	7.00	7.05	
E1		5.60			5.60		
e		0.80			0.80		
Z		0.70			0.70		
ddd			0.08			0.08	
eee			0.09			0.09	(4)
fff			0.05			0.05	(5)

NOTES:

- (1) - LFBGA stands for **L**ow profile **F**ine Pitch **B**all **G**rid **A**rray.
 - Thin profile: 1.00mm < A ≤ 1.20mm / Fine pitch: e < 1.00mm pitch.
 - The total profile height (Dim A) is measured from the seating plane to the top of the component
 - The maximum total package height is calculated by the following methodology:
 $A \text{ Max} = A1 \text{ Typ} + A2 \text{ Typ} + A4 \text{ Typ} + \sqrt{A1^2 + A2^2 + A4^2}$ tolerance values
- (2) – The typical ball diameter before mounting is 0.40mm.
- (3) – LFBGA with 0.40mm pitch is not yet registered into JEDEC Publications.
- (4) - The tolerance of position that controls the location of the pattern of balls with respect to datums A and B. For each ball there is a cylindrical tolerance zone eee perpendicular to datum C and located on true position with respect to datums A and B as defined by e. The axis perpendicular to datum C of each ball must lie within this tolerance zone.
- (5) - The tolerance of position that controls the location of the balls within the matrix with respect to each other. For each ball there is a cylindrical tolerance zone fff perpendicular to datum C and located on true position as defined by e. The axis perpendicular to datum C of each ball must lie within this tolerance zone. Each tolerance zone fff in the array is contained entirely in the respective zone eee above. The axis of each ball must lie simultaneously in both tolerance zones.
- (6) - The terminal A1 corner must be identified on the top surface by using a corner chamfer, ink or metallized markings, or other feature of package body or integral heatslug.
 - A distinguishing feature is allowable on the bottom surface of the package to identify the terminal A1 corner. Exact shape of each corner is optional.

5.3 Marking field template and descriptors

The MCDP28x0 marking template is shown below.

Figure 8. Marking template

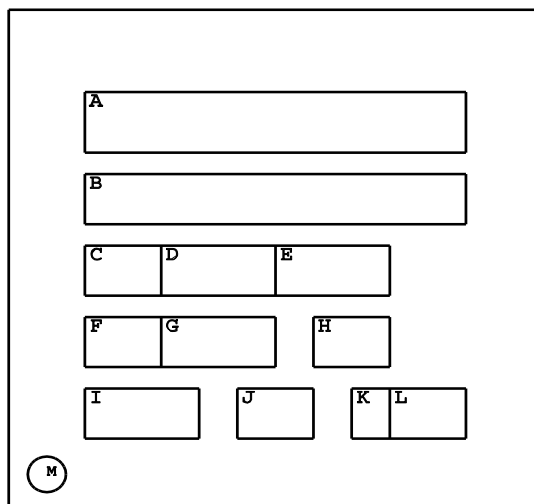

Field descriptors are shown below.

Table 7. Field descriptors

Field	Description	Marking
A	MegaChips logo	MegaChips
B	Product code	One of the codes below: MCDP2800BB MCDP2850BB MCDP2800BC MCDP2850BC
C	2-character diffusion plant code	VQ
D	3-digit wafer start date	“YWW”
E	3-character FE sequence code	“ABC”
F	2-character assembly plant code	99
G	3-character BE sequence code	“XYZ”
H	Optional marking	<blank> or ES ⁽¹⁾
I	3-character country of origin code	MYS
J	2-digit test plant code	8U
K	1-digit assembly year	“Y”
L	2-digit assembly week	“WW”
M	Ball A1 identifier	a DOT

1. Marked ES for Engineering Samples, used for development purposes.

5.4 Classification reflow profile

Please refer to the DisplayPort Application Note: Classification reflow profile for SMD devices (C0353-APN-06) for reflow diagram and details.

6. Electrical specifications

6.1 Absolute maximum ratings

Applied conditions greater than those listed under “Absolute maximum ratings” may cause permanent damage to the device. The device should never exceed absolute maximum conditions since it may affect device reliability.

Table 8. Absolute maximum ratings

Parameter	Symbol	Min	Typ	Max	Units
3.3 V supply voltages ^(1,2)	V _{VDD_3.3}	-0.3	3.3	3.96	V
1.2 V supply voltages ^(1,2)	V _{VDD_1.2}	-0.3	1.2	1.44	V
Input voltage tolerance for 3.3 V, 5 V tolerant I/O pins	V _{IN5tol}	-0.3		5.5	V
Input voltage tolerance for 3.3 V I/O pins	V _{IN3V3}	-0.3		3.63	V
ESD – Human Body Model (HBM) [JESD22-A114 spec] For all pins	V _{ESD}			+/- 2.0	kV
ESD – Human Body Model (HBM) [IEC61000-4 spec] For DP and HDMI connector-facing pins	V _{ESD}	-	-	+/- 6.5	kV
ESD – Charged Device Model (CDM)	V _{ESD}	-	-	+/- 500	V
Latch-up ^(3,4)	I _{LA}	-	-	+/- 100	mA
Ambient operating temperature	T _A	0	-	70	°C
Storage temperature	T _{STG}	-40	-	150	°C
Operating junction temperature	T _J	0	75	125	°C
Thermal resistance (Junction to Ambient) ⁽⁵⁾	θ _{JA}	-	-	49.0	°C/W
Thermal resistance (Junction to Case) ⁽⁵⁾	θ _{JC}	-	-	20.1	°C/W
Peak IR reflow soldering temperature	T _{SOL}	-	-	260	°C

Note (1): All voltages are measured with respect to GND.

Note (2): Absolute maximum voltage ranges are for transient voltage excursions.

Note (3): For connector facing pins CONFIG1 and DPRX_HPDI_OUT, a series resistor of 100 ohms is recommended. Refer to the MCDP28x0 Layout Guideline appnote.

Note (4): JEDEC Class1.

Note (5): These are simulated results under the following conditions: Four layer JEDEC PCB, no heat spreader, Air flow = 0 m/s.

6.3 DC characteristics

Table 9. DC characteristics

Parameter	Symbol	Min	Typ	Max	Units
3.3 V supply voltages (analog and digital)	V _{VDD_3.3}	3.14	3.3	3.47	V
1.2 V supply voltages (analog and digital)	V _{VDD_1.2}	1.14	1.2	1.26	V
Power					
Protocol converter Mode Measurement condition: Nominal corner, 25°C, Nominal power supply 4k x 2k / 60 Hz 4L HBR2 to HDMI test pattern: ON-OFF dot Moire attributes-based rendering			412	460	mW
Analog PHY repeater mode			100	120	mW
Sleep State			18	20	mW
Connected standby mode			0.1	0.2	mW
Supply current					
Measurement conditions: Nominal corner, 25°C, Nominal power supply 4k x 2k @60 MHz 4L HBR to HDMI2.0a VDD (analog and digital) 3.3V VDD (analog and digital) 1.2V				30 300	mA

Note: Ripple amplitude for power supplies should be 30 mV or lower with max ripple frequency of up to 30 MHz.

Table 10. IO DC characteristics

Parameter	Symbol	Min	Typ	Max	Units
Inputs 3.3 V IO signals, 5 V tolerant open drain type					
High voltage	V _{IH}	2.0		5.5	V
Low voltage	V _{IL}	-0.3		0.8	V
Input Hysteresis voltage	V _{HYST}	300			mV
High current (V _{IN} = 3.3 V)	I _{IH}			+/- 10	μA
Low current (V _{IN} = 0.8 V)	I _{IL}			+/- 10	μA
Input capacitance	C _{IN}		5		pF
Outputs 3.3 V IO signals, 5 V tolerant open drain type					

Low Current ($V_{OL} = 0.2\text{ V}$)	I_{OL}	4			mA
Tri-state leakage current	I_{OZ}			10	μA
VDD12_ON output					
Output Low Voltage ($I_{OL}=0.25\text{mA}$)	V_{OL}			0.4	V
Output High Voltage($I_{OH}=0.25\text{mA}$)	V_{OH}	2.9			V
Low Level output Current	I_{OL}	0.25			
High Level Output Current	I_{OH}	0.25			
Inputs 3.3 V IO signals, 3.3 V tolerant, TRISTATE					
High voltage	V_{IH}	2.0			V
Low voltage	V_{IL}			0.8	V
Input Hysteresis voltage	V_{HYST}	300			mV
High current ($V_{IN} = 3.3\text{ V}$)	I_{IH}			± 10	μA
Low current ($V_{IN} = 0.8\text{ V}$)	I_{IL}			± 10	μA
Input capacitance	C_{IN}		1.0		pF
Outputs 3.3 V IO signals, 3.3 V tolerant, TRISTATE					
Rout	Output Impedance, $V_{OL}=0.3\text{V}$		50		Ω
Rout	Output Impedance, $V_{DDE3V3}-0.3\text{V}$		50		Ω
Tri-state leakage current	I_{OZ}			± 10	μA

6.4 AC characteristics

Table 11. Maximum speed of operation

Clock domain	Max speed of operation
Reference Input Clock (TCLK)	27 MHz
Reference Internal Clock (RCLK)	324 MHz
On-Chip Microcontroller Clock (OCLK)	150 MHz
2-Wire Serial Slave (SLAVE_SCL)	400 kHz
2-Wire Serial Master (MSTRx_SCL)	400 kHz
SPI Clock	50 MHz

6.4.1 DisplayPort receiver

Table 12. DisplayPort receiver characteristics

Parameter	Symbol	Min	Typ	Max	Units	Comments
Receiver operating range						
Differential Input Voltage Range	$V_{RX_DIF_PP_RANGE}$		0.04~1		V	
RX Termination Control Range	$R_{RX_TERM_RANGE}$		80 ~120		ohm	
DisplayPort receiver system parameters						
HBR2 unit interval (5.4Gbps)	UI_{HBR2}		185		ps	
HBR unit interval (2.7Gbps)	UI_{HBR}		370		ps	
RBR unit interval (1.62Gbps)	UI_{RBR}		617		ps	
Link clock down spreading		0		0.5	%	Modulation frequency range Of 30 kHz to 33 kHz
DisplayPort receiver TP3 parameters						
Receiver Eye TP3 RBR	$T_{RBR_EYE_TP3}$	0.25			UI	@ 40mV V_{diff_pp}
Receiver Eye TP3_EQ HBR	$T_{HBR_EYE_TP3EQ}$	0.4			UI	@ 135mV V_{diff_pp}
Receiver Eye TP3_EQ HBR2	$T_{HBR2_EYE_TP3EQ}$	0.3			UI	@ 70mV V_{diff_pp}
Lane intra-pair skew tolerance	$T_{SKEW_INTRA_RBR}$			260	ps	Skew contribution from the cable in addition to the stressed EYE at TP3.
	$T_{SKEW_INTRA_HBR}$			60	ps	
	$T_{SKEW_INTRA_HBR2}$			50	ps	
DJ Non-ISI at 1.62 Gbps	$T_{RX_DJ_RBR}$			0.186	UI	1.62Gbps signal @ package pins
DJ Non-ISI at 2.7 Gbps	$T_{RX_DJ_HBR}$			0.339	UI	2.7Gbps signal @ package pins
DJ at 5.4 Gbps	$T_{RX_DJ_HBR2}$			0.57	UI	5.4 Gbps signal @ package pins
TJ at 1.62 Gbps	$T_{RX_TJ_RBR}$			0.78	UI	1.62Gbps signal @ package pins
TJ at 2.7 Gbps	$T_{RX_TJ_HBR}$			0.53	UI	2.7Gbps signal @ package pins
TJ at 5.4 Gbps	$T_{RX_TJ_HBR2}$			0.7	UI	5.4 Gbps signal @ package pins

Parameter	Symbol	Min	Typ	Max	Units	Comments
AUX parameters						
Differential Input Voltage Range	$V_{AUX_RX_DIF_RANGE}$		0.14~1		V	
RX Termination Control Range	$R_{AUX_TERM_RANGE}$		40~60		ohms	
AUX TX peak-peak Range	$V_{AUX_TX_DIF_PP}$		0~1		V	7.8125mV/step in 128 steps

6.4.2 HDMI transmitter I/O specifications

Table 13. HDMI transmitter I/O specifications

Parameters	Symbol	Min	Typ	Max	Unit	Comments
Differential output: single ended swing amplitude	V_{TX_PP}	0.4	0.5	0.6	V	
Differential output: Differential swing amplitude	$V_{TX_DIF_PP}$	0.8	1	1.2	V	
Differential high level output	$V_{TX_DIF_HIGH}$	3.12	3.3	3.49	V	
Differential low level output	$V_{TX_DIF_LOW}$	3.12		3.49	V	

Table 14. HDMI transmitter AC characteristics

Parameters	Symbol	Min	Typ	Max	Unit	Comments
TMDS Character Clock	$f_{TX_CHR_CLK}$	25		600	MHz	Programmable
Differential Output Voltage	$V_{TX_DIF_PP}$	0		1200	mV	In 128 steps
TX Edge Rate	t_{TX_ER}	75		145	pS	1V $V_{TX_DIF_PP}$ and Preemphasis at 0dB in 8 steps
TX Pre-Emphasis Level	A_{PREMPH}	0		6	dB	1V $V_{TX_DIF_PP}$ in 16 steps
TX Termination Control Range	$R_{TX_TERM_RANGE}$	100		600	ohms	Programmable Termination
TX Jitter <1.65Gbps for Pattern _{D10.2}	$T_{TX_J_D102_LF}$			60	pS	
TX Jitter <1.65Gbps for Pattern _{PRBS7}	$T_{TX_J_PRBS7_LF}$			70	pS	
TX Jitter >1.65Gbps, < 3.4Gbps for Pattern _{D10.2}	$T_{TX_J_D102_MF}$			35	pS	
TX Jitter >1.65Gbps, < 3.4Gbps for Pattern _{PRBS7}	$T_{TX_J_PRBS7_MF}$			45	pS	

TX Jitter >3.4Gbps for Pattern _{D10.2}	$T_{TX_J_D102_HF}$			30	pS	
TX Jitter >3.4Gbps for Pattern _{PRBS7}	$T_{TX_J_PRBS7_HF}$			35	pS	

6.4.3 I2C interface timing

Table 15. I2C interface timing

Symbol	Parameter	Conditions	Min	Typ	Max	Unit
f_{SCL}	SCL clock rate	Fast mode	0	-	400	kHz
$t_{HD;STA}$	Hold time START	After this period, the 1 st clock starts	1.2	-	-	μ S
t_{LOW}	Low period of clock	SCL	1.3	-	-	μ S
t_{HIGH}	High period of clock	SCL	1.2	-	-	μ S
$T_{su;STA}$	Set up time for a repeated START		1.2	-	-	μ S
$t_{HD;DAT}$	Data hold time	For master	0.7	-	0.9 ⁽¹⁾	μ S
$t_{su;DAT}$	Data setup time		380	-	-	ns
T_{BUF}	Bus free time between STOP and START		1.3	-	-	μ S
C_b	Capacitance load for each bus line		-	100	400	pF
t_r	Rise time		220	-	300	ns
t_f	Fall time		60	-	300	ns
V_{nh}	Noise margin at high level		0.25VDD	-	-	V
V_{nl}	Noise margin at low level		0.2VDD	-	-	

Note: The maximum $t_{HD;DAT}$ only has to be met if the device does not stretch the low period t_{LOW} of the SCL signal. In the diagram below, S = start, P = stop, Sr = Repeated start, and SP= Repeated stop conditions.

Figure 9. I2C timing

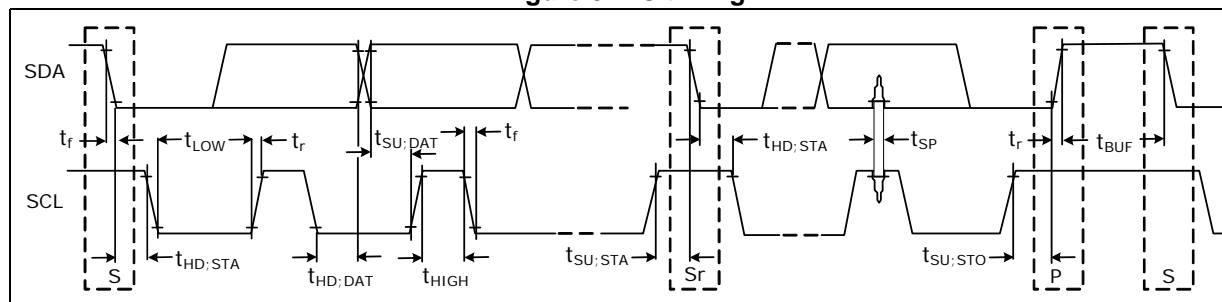

6.4.4 SPI interface timing

Table 16. SPI interface timing, VDD = 3.3 V

Symbol	Parameter	Min	Typ	Max	Units
F _{CLK}	SPI_CLK output clock frequency		50		MHz
T _{SCKH}	Serial clock high time		20		ns
T _{SCKL}	Serial clock low time		20		ns
T _{R_SPI_CLK}	SPI_CLK rise time @10mA drive 10pF load			2.8	ns
T _{F_SPI_CLK}	SPI_CLK fall time @10mA drive 10pF load			3.2	ns
T _{MEM_CLK_F}	Device speed		75		MHz
T _{MEM_CSN_SU}	Device CSN input setup time requirement			7	ns
T _{MEM_CSN_HLD}	Device CSN input setup time requirement			7	ns
T _{MEM_DO_PD}	Device DO out propagation delay			6	ns
T _{MEM_DI_SU}	Device DI setup time			3	ns
T _{MEM_DI_SU}	Device DI hold time			5	ns

7. Ordering information

Table 17. Order codes

Part number	Description
MCDP2800-BBES	64 LFBGA (7 x 7 x 1.4 mm) for motherboard-down application. Engineering samples, for development purpose only. (Rev BB silicon)
MCDP2800-BB	64 LFBGA (7 x 7 x 1.4 mm) for motherboard-down application. Mass production parts. Delivered in trays. (Rev BB silicon)
MCDP2800-BBT	64 LFBGA (7 x 7 x 1.4 mm) for motherboard-down application. Mass production parts. Delivered in tape and reel. (Rev BB silicon)
MCDP2850-BB	64 LFBGA (7 x 7 x 1.4 mm) for dongle application. Delivered in trays. (Rev BB silicon)
MCDP2850-BBT	64 LFBGA (7 x 7 x 1.4 mm) for dongle application. Delivered in tape and reel. (Rev BB silicon)
MCDP2800-BC	64 LFBGA (7 x 7 x 1.4 mm) for motherboard-down application. Mass production parts. Delivered in trays. (Rev BC silicon)
MCDP2800-BCT	64 LFBGA (7 x 7 x 1.4 mm) for motherboard-down application. Mass production parts. Delivered in tape and reel. (Rev BC silicon)
MCDP2850-BC	64 LFBGA (7 x 7 x 1.4 mm) for dongle application. Delivered in trays. (Rev BC silicon)
MCDP2850-BCT	64 LFBGA (7 x 7 x 1.4 mm) for dongle application. Delivered in tape and reel. (Rev BC silicon)

8. Revision history

Table 18. Document revision history

Date	Revision	Changes
09-Mar-2016	A	Initial version.
07-Apr-2016	B	Updated HDMI2.0 to HDMI2.0a throughout the datasheet. Added sub-bullet to Features section.

Notice

Semiconductor products may possibly experience breakdown or malfunction. Adequate care should be taken with respect to the safety design of equipment in order to prevent the occurrence of human injury, fire or social loss in the event of breakdown or malfunction of semiconductor products

The overview of operations and illustration of applications described in this document indicate the conceptual method of use of the semiconductor product and do not guarantee operability in equipment in which the product is actually used.

The names of companies and trademarks stated in this document are registered trademarks of the relevant companies.

MegaChips Co. provides no guarantees nor grants any implementation rights with respect to industrial property rights, intellectual property rights and other such rights belonging to third parties or/and MegaChips Co. in the use of products and of technical information including information on the overview of operations and the circuit diagrams that are described in this document.

The product described in this document may possibly be considered goods or technology regulated by the Foreign Currency and Foreign Trade Control Law. In the event such law applies, export license will be required under said law when exporting the product. This regulation shall be valid in Japan domestic.

In the event the intention is to use the product described in this document in applications that require an extremely high standard of reliability such as nuclear systems, aerospace equipment or medical equipment for life support, please contact the sales department of MegaChips Co. in advance.

All information contained in this document is subject to change without notice.

Copyright ©2016 MegaChips Corporation All rights reserved

MegaChips Corporation
Head Quarters
1-1-1 Miyahara, Yodogawa-ku Osaka 532-0003, Japan
TEL: +81-6-6399-2884

MegaChips Corporation
Tokyo Office
17-6 Ichiban-cho, Chiyoda-ku, Tokyo 102-0082, Japan
TEL: +81-3-3512-5080

MegaChips Corporation
Makuhari Office
1-3 Nakase Mihama-ku Chiba 261-8501, Japan
TEL: +81-43-296-7414

MegaChips Corporation
San Jose Office
2033 Gateway Place, Suite 400, San Jose, CA 95110 U.S.A.
TEL: +1-408-570-0555

MegaChips Corporation
India Branch
17th Floor, Concorde Block UB City,
Vittal Mallya Road, Bangalore 560-001, India
TEL: +91-80-4041-3999

MegaChips Corporation
Taiwan Branch
RM. B 2F, Worldwide House, No.129,
Min Sheng E. Rd., Sec. 3, Taipei 105, Taiwan
TEL: +886-2-2547-1297

MegaChips Corporation
Tainan Office
RM. 2, 8F, No.24, Da Qiao 2 Rd., Yong Kang Dist.,
Tainan 710, Taiwan
TEL: +886-6-302-2898

MegaChips Corporation
Zhunan Office
No.118, Chung-Hua Rd., Chu-Nan, Miao-Li 350, Taiwan
TEL: +886-37-666-156

MegaChips Corporation
Shenzhen Office
Room 6307, Office Tower, Shun Hing Square, 5002
Shen Nan Dong Road, Luohu District,
Shenzhen 518000, P. R. China
TEL: +86-755-3664-6990