

Specification

Part No. : WA.500w.301151

Product Name : Stingray Adhesive Mount
Wi-Fi/Zigbee Antenna

Features : Dual Band 2.4-2.5 GHz, 4.9-6.0 GHz
IP-65 Water Resistance
RG-174 – 3M, RP-SMA(M)
RoHS Compliant



1. Introduction

The WA.500w Stingray is a high efficiency, high gain adhesive mount dual band wireless antenna. Its high quality low profile covert housing can be attached onto the glass or plastic. The WA.500w is designed for applications that require omni-directional gain across both bands to ensure wide coverage area and constant reception and transmission for Wi-Fi and ZigBee applications.

Many module manufacturers specify peak gain limits for any antennas that are to be connected to that module. Those peak gain limits are based on free-space conditions. In practice, the peak gain of an antenna tested in free-space can degrade by at least 1 or 2dBi when put inside a device. So ideally you should go for a slightly higher peak gain antenna than mentioned on the module specification to compensate for this effect, giving you better performance.

Upon testing of any of our antennas with your device and a selection of appropriate layout, integration technique, or cable, Taoglas can make sure any of our antennas' peak gain will be below the peak gain limits. Taoglas can then issue a specification and/or report for the selected antenna in your device that will clearly show it complying with the peak gain limits, so you can be assured you are meeting regulatory requirements for that module.

For example, a module manufacturer may state that the antenna must have less than 2dBi peak gain, but you don't need to select an embedded antenna that has a peak gain of less than 2dBi in free-space. This will give you a less optimized solution. It is better to go for a slightly higher free-space peak gain of 3dBi or more if available. Once that antenna gets integrated into your device, performance will degrade below this 2dBi peak gain due to the effects of GND plane, surrounding components, and device housing. If you want to be absolutely sure, contact Taoglas and we will test. Choosing a Taoglas antenna with a higher peak gain than what is specified by the module manufacturer and enlisting our help will ensure you are getting the best performance possible without exceeding the peak gain limits.

Cables and Connectors are customizable.

2. Specifications

ELECTRICAL	
Frequency	2.4/5.8GHz
Polarization	Linear
Impedance	50Ω
VSWR	1.92 Max
Base Diameter	55mm
MECHANICAL	
Base Height	10.8mm
Dimensions	Diameter 55mm Height 10.80mm
Colour	Black
Connector	RP-SMA(M), Fully Customizable
Cable	RG174 Length = 3M, Fully Customizable
Weight	62g

2.4 Efficiency, Average Gain, & Peak Gain without cable

Frequency	Efficiency (%)		Average Gain dBi		Peak Gain dBi	
	On Plastic	On Glass	On Plastic	On Glass	On Plastic	On Glass
2400	30.421	48.78	-6.957	-4.475	2.452	5.382
2450	48.09	49.605	-4.217	-4.329	4.2	6.886
2500	57	46.247	-3.473	-4.687	4.933	5.844
5000	67.232	42.28	-2.45967	-3.64833	8.991	3.736
5150	71	42.7	-2.11333	-3.94167	9.161	4.532
5200	65.933	43.03	-2.448	-4.434	8.901	4.481
5250	72	43.398	-1.852	-4.18833	9.154	5.129
5300	63.761	40.8	-2.279	-4.954	8.502	4.369
5350	72.267	43.751	-1.65933	-4.11033	8.906	5.757
5400	61.363	42.88	-2.311	-4.658	7.905	5.056
5450	68.398	43.649	-1.74467	-4.076	8.135	4.739
5500	68.624	43.413	-1.69933	-4.00933	7.985	4.564
5550	70.21	45.55	-1.51533	-3.73533	7.907	5.094
5600	66.97	44.11	-1.72333	-3.898	7.656	4.863
5650	66.678	43.04	-1.78233	-3.841	7.635	4.205
5700	62.174	41.88	-2.12867	-3.92433	7.394	4.062
5750	68.187	42.21	0.311333	-4.013	7.859	4.917
5800	70.44	44.052	-1.505	-3.76133	7.901	4.308
5825	67.31	42.43	-2.113	-4.32467	7.769	3.615
5850	69.353	40.583	-1.62233	-4.21933	7.899	3.487
5875	76.068	45.984	-1.22067	-3.56	8.091	3.856
5900	69.981	43.385	-2.24767	-3.78733	7.611	3.990
5925	70.424	43.379	-1.581	-3.83533	7.701	4.262
5950	70.742	42.749	-1.59033	-3.876	7.755	3.899
6000	72.374	56.95	-1.51533	-3.48933	7.701	3.239
Plastic Dimension				520*520*13.8mm, PC+ABS		
Glass Dimension				500*500*3mm ³		

Efficiency vs. Frequency (Measured with glass)

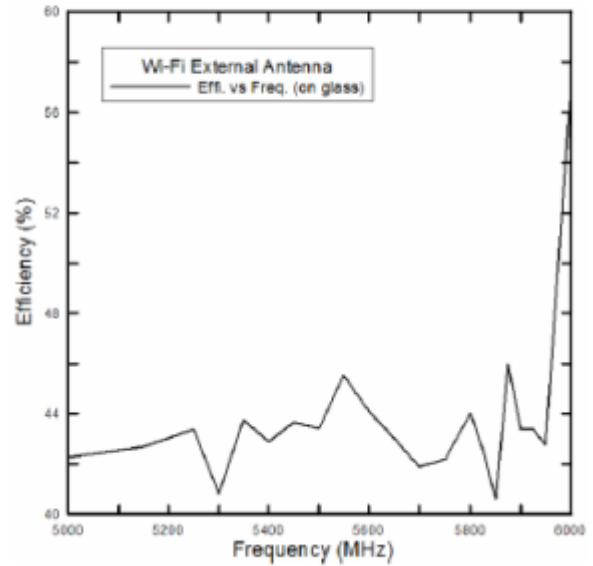
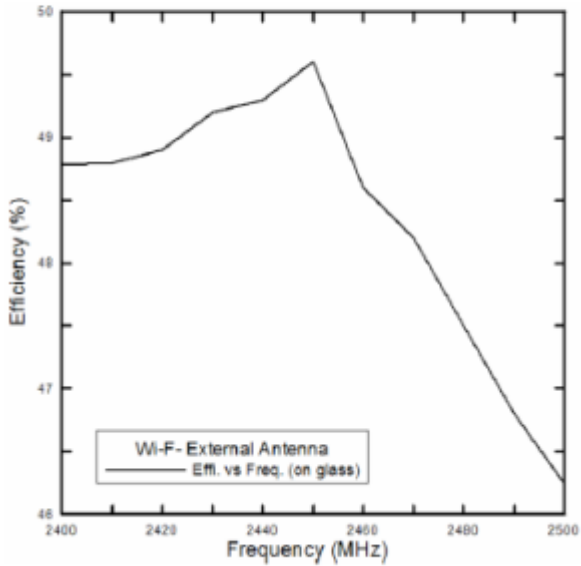

Average Gain vs. Frequency (Measured with glass)

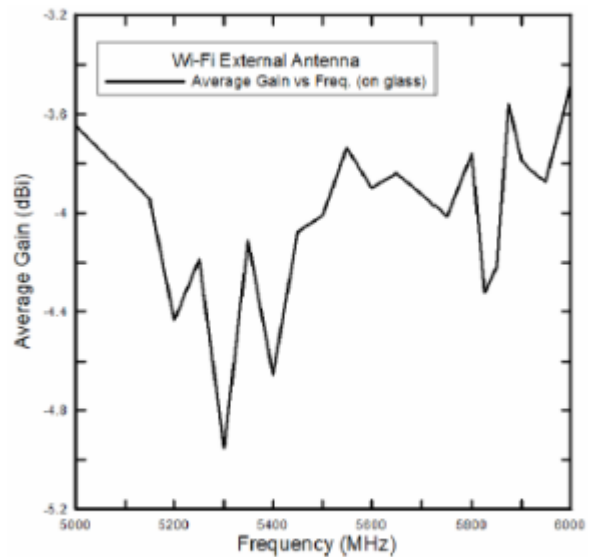
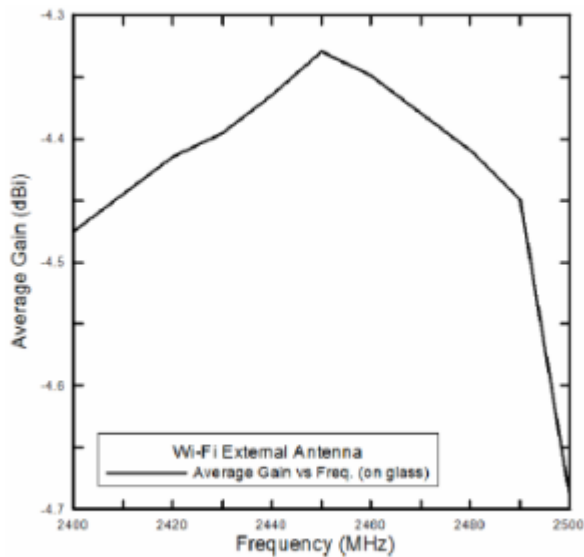

Peak Gain vs. Frequency (Measured with glass)

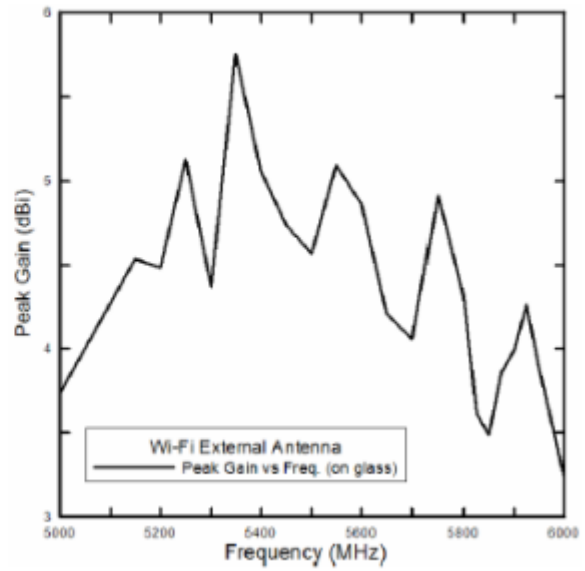
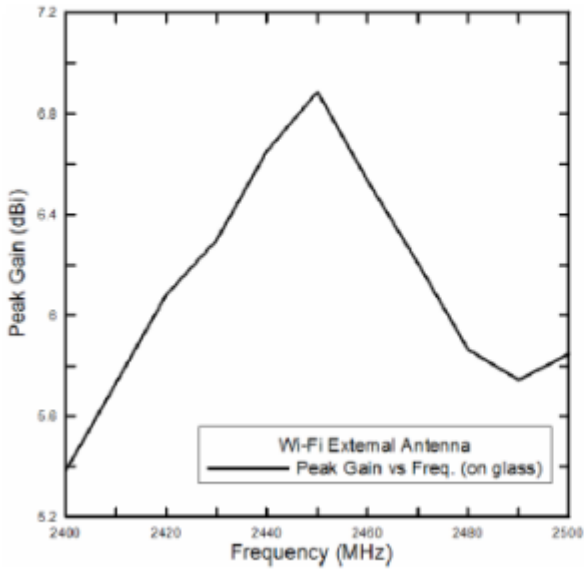

Efficiency vs. Frequency (Measured with plastic)

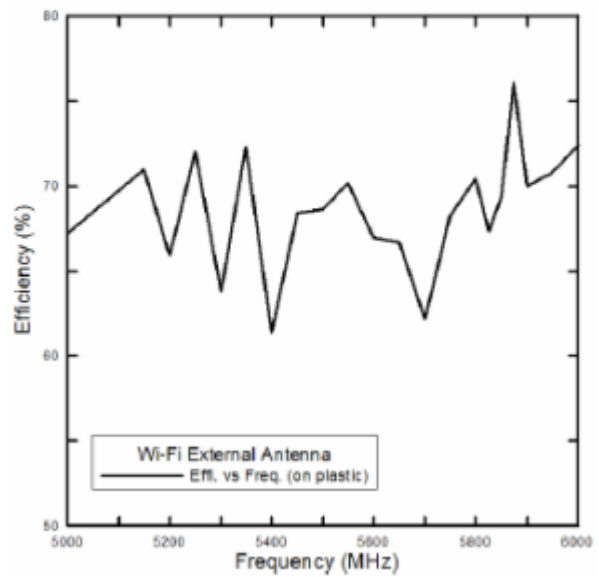
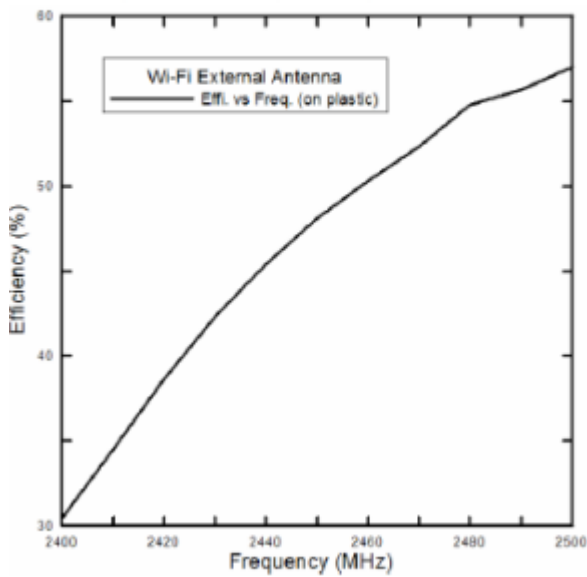

Average Gain vs. Frequency (Measured with plastic)

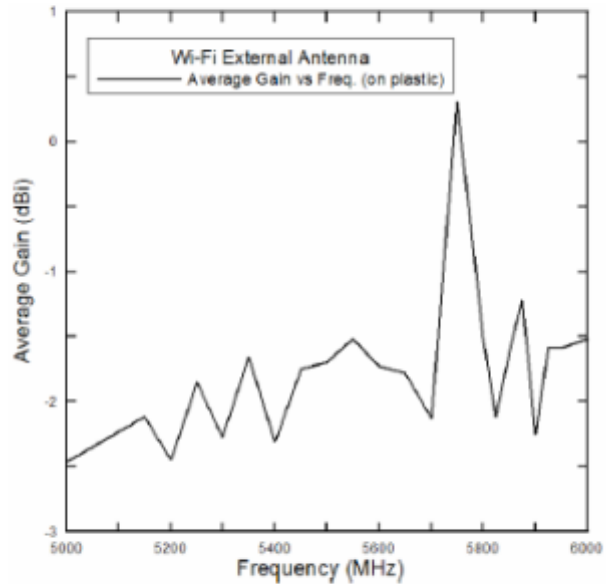
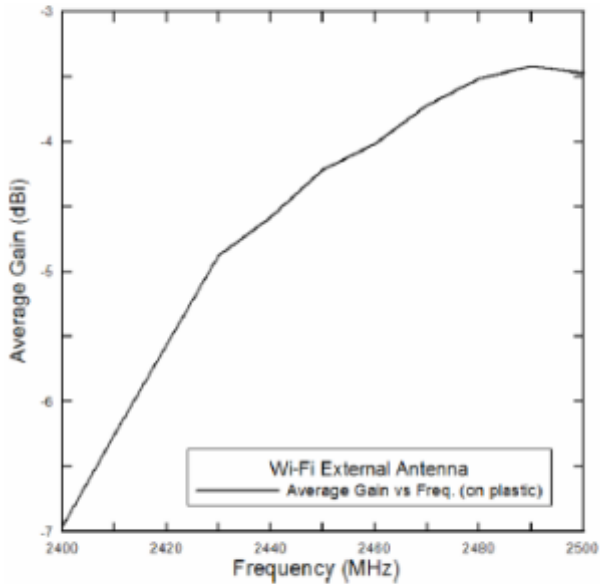

Peak Gain vs. Frequency (Measured with plastic)

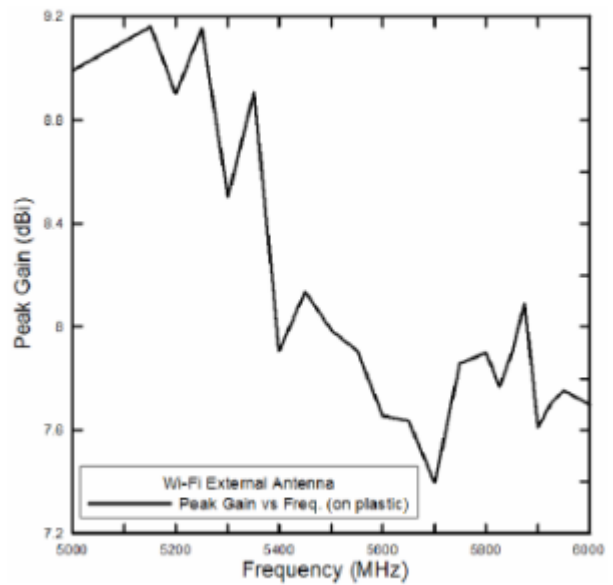
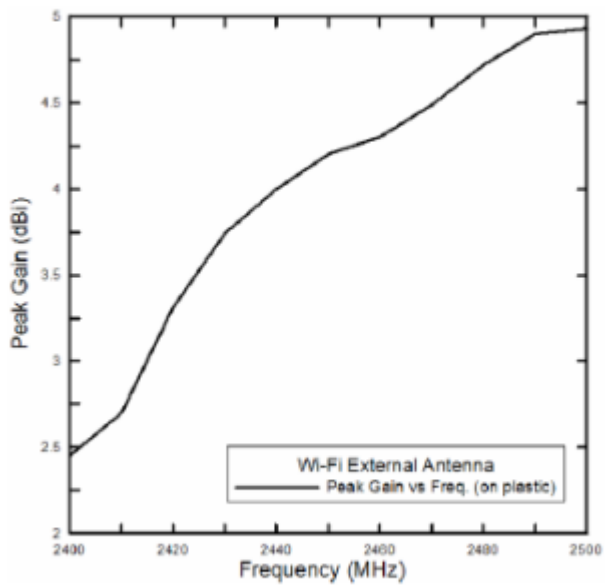

3.Drawing

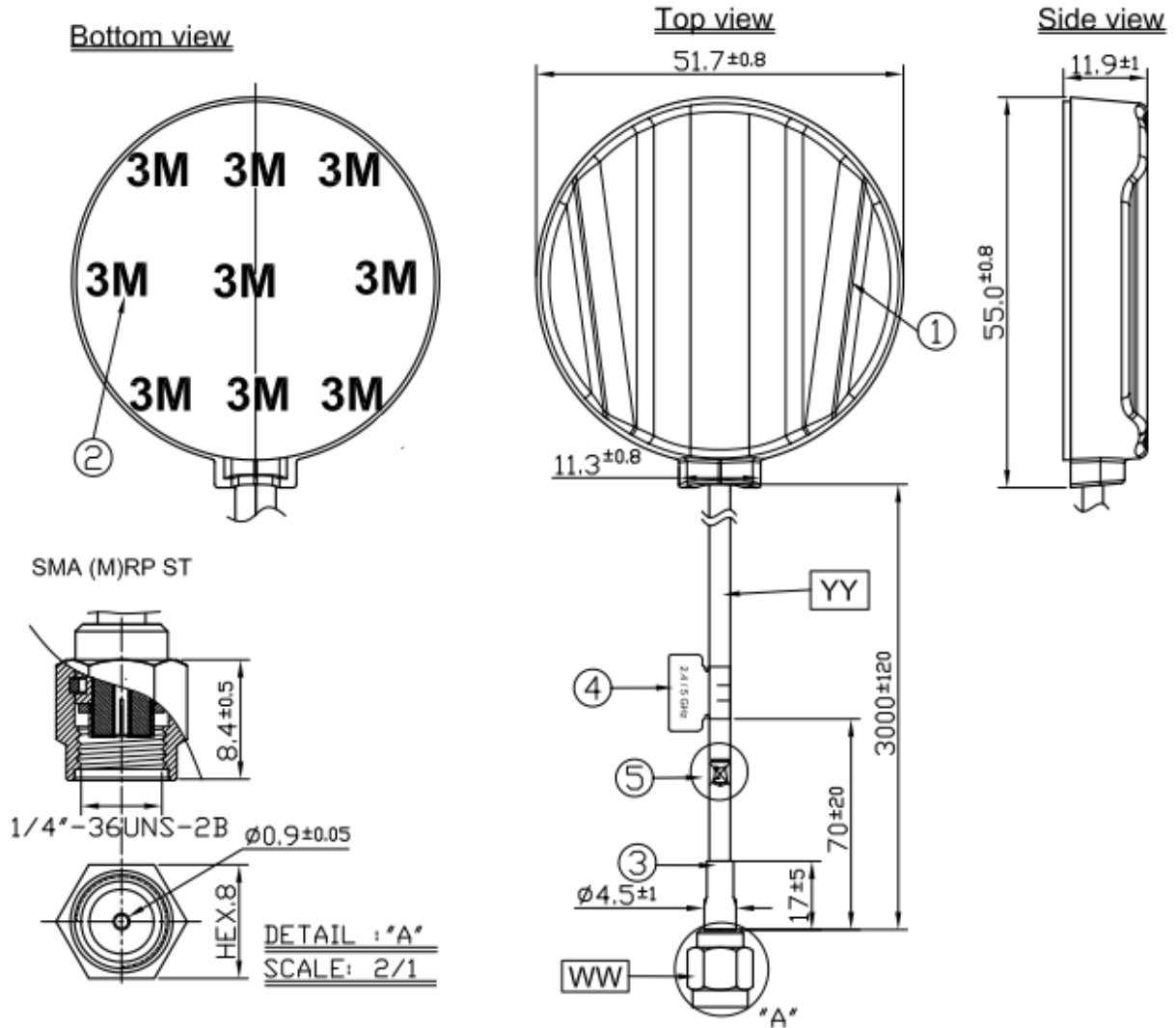

	Name	Material	Finish	QTY
1	Housing	ABS	Black	1
2	Acrylic Foam Tape	3M 4612	White Liner	1
3	Heat Shrink tube	PE	Black	1
4	2.4/5GHz Label	Coated Paper	Green	1
5	WEEE Label	Coated Paper	White	1

	Name	Spec	Finish	QTY
WW	Connector Type	SMA(M) RP ST RG174	Gold	1
YY	Cable Type	RG174 Cable	Black	1

4. Testing

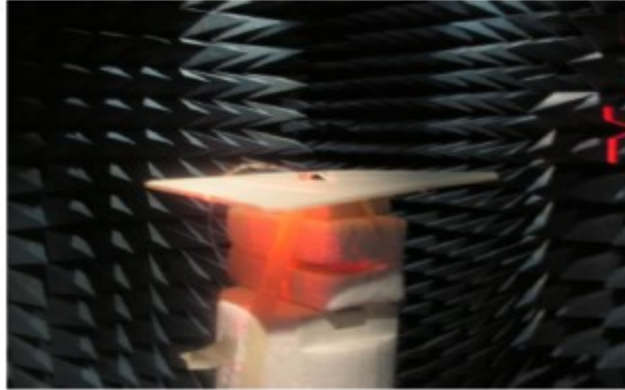

Testing Wi-Fi Antenna in 3D Chamber

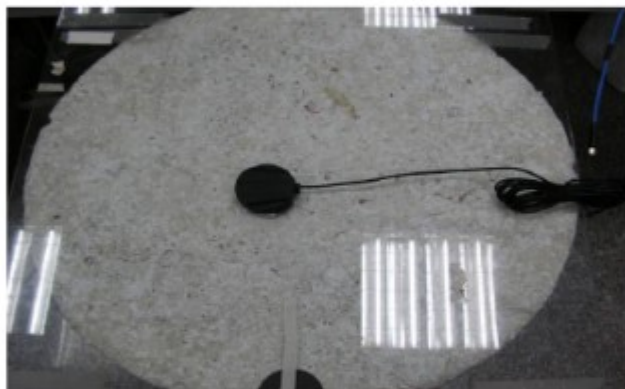

Wi-Fi Antenna test with glass



Wi-Fi antenna test with plastic

Wi-Fi Antenna Return Loss

(Measured with RG-174 cable, length=3 M)

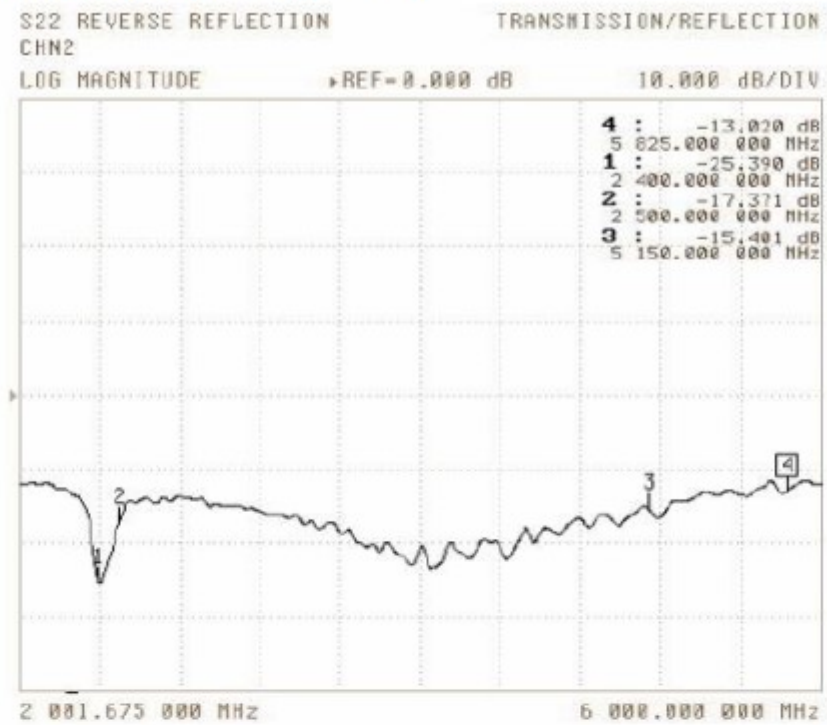

Measured with glass (500*500*3mm³)

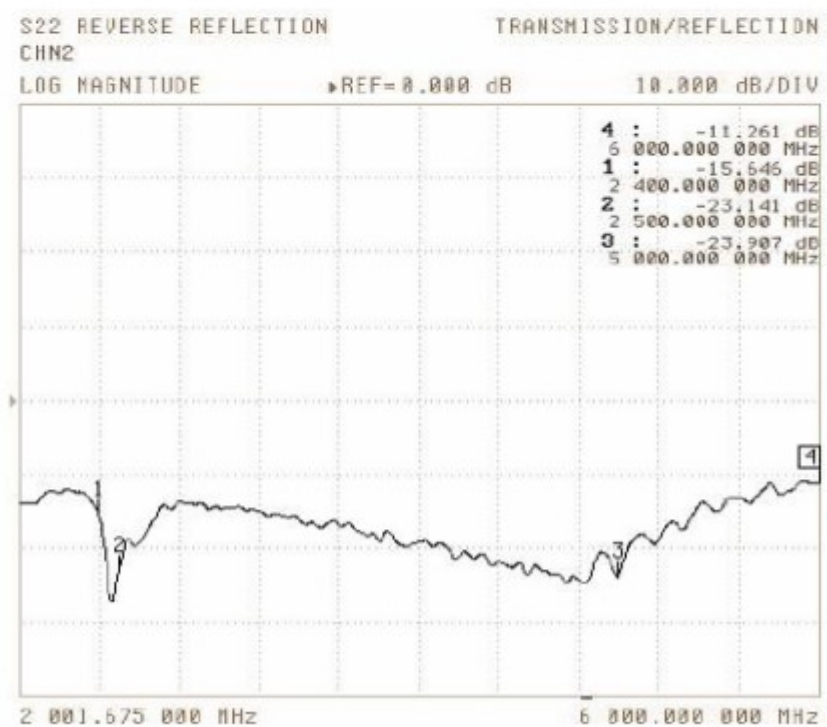

Measured with glass (520*520*13.8mm³)

Wi-Fi Antenna Radiation Patterns

Measured with glass

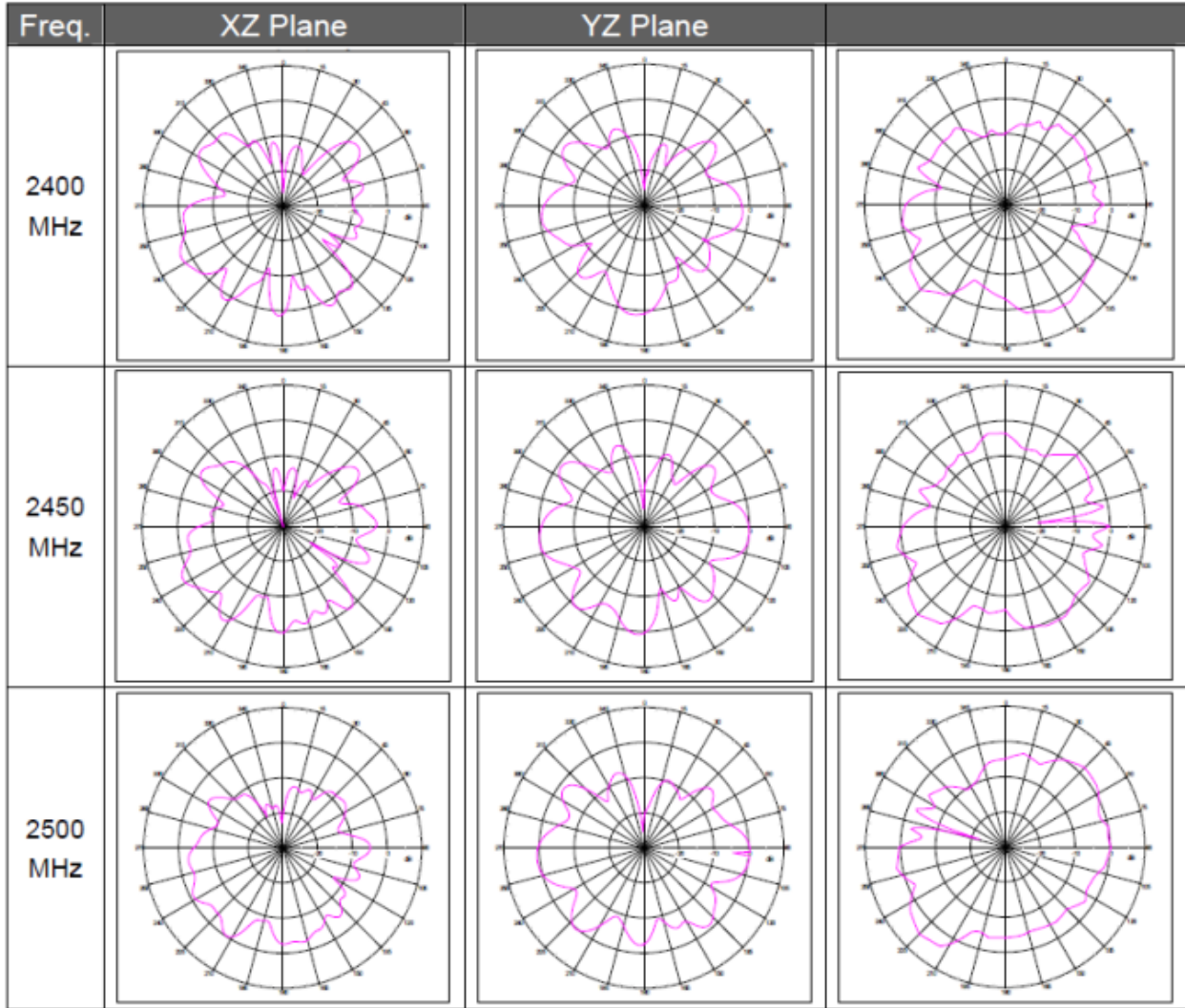

RG-174 cable attenuation (dB/100m)

GHz	0.5	1	1.5	2	2.5	3	3.5	4	4.5	5	5.5	6
RG-174	67	110	127	153	168	183	207	229	252	272	291	311

Wi-Fi Antenna Radiation Patterns (con.)

Measured with glass

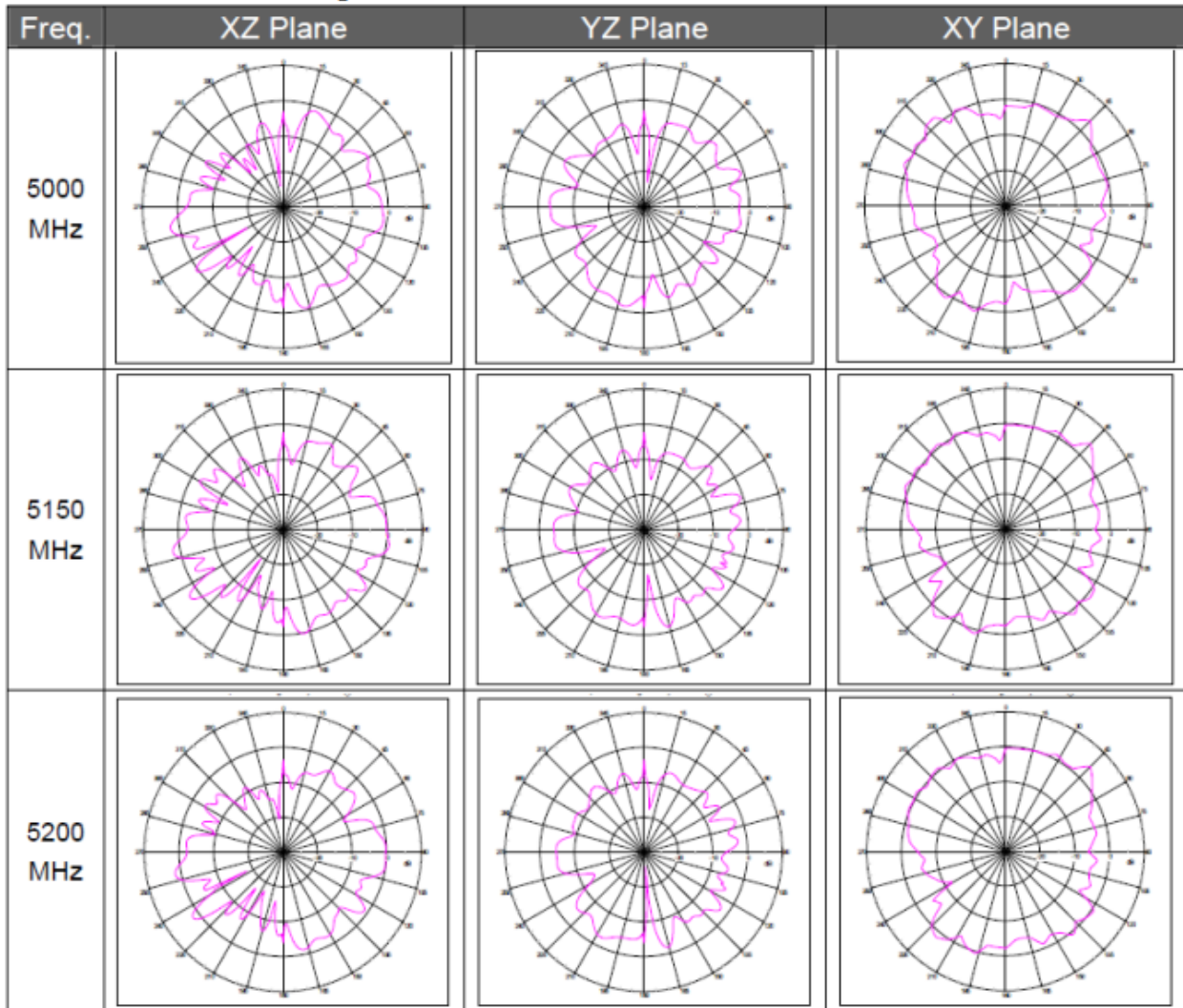

Wi-Fi Antenna Radiation Patterns (con.)

Measured with glass

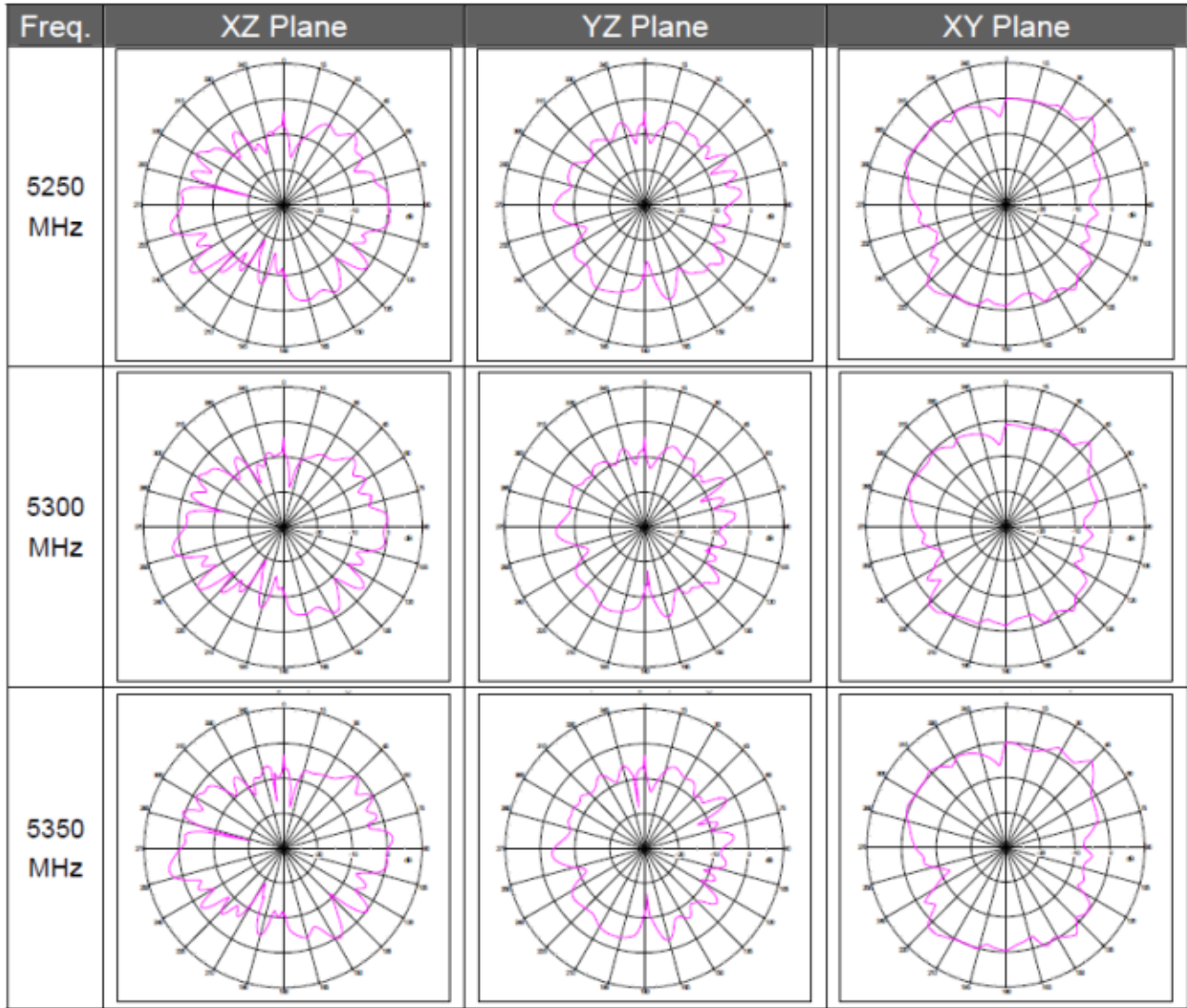

Wi-Fi Antenna Radiation Patterns (con.)

Measured with glass

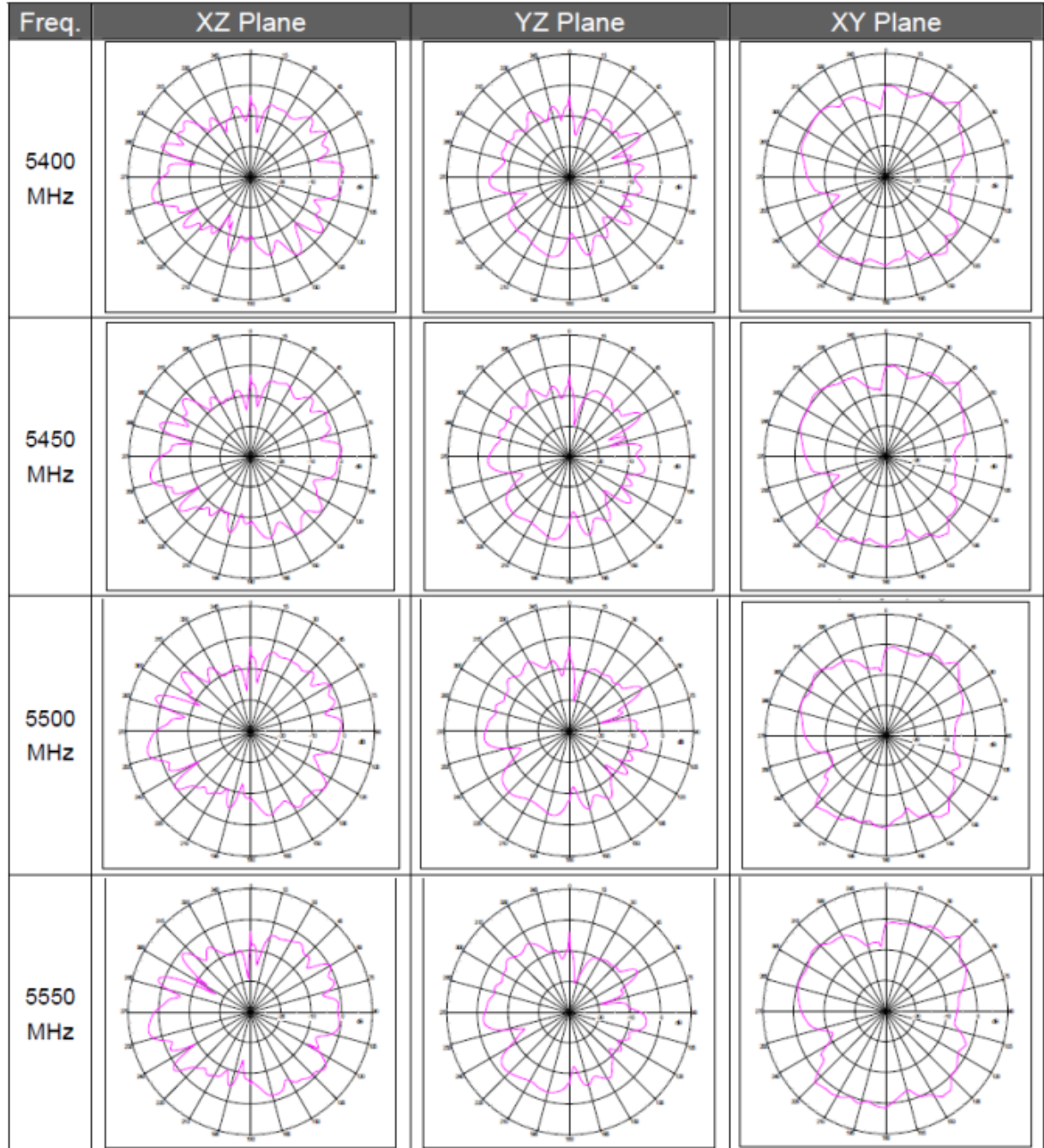

Wi-Fi Antenna Radiation Patterns (con.)
 Measured with glass

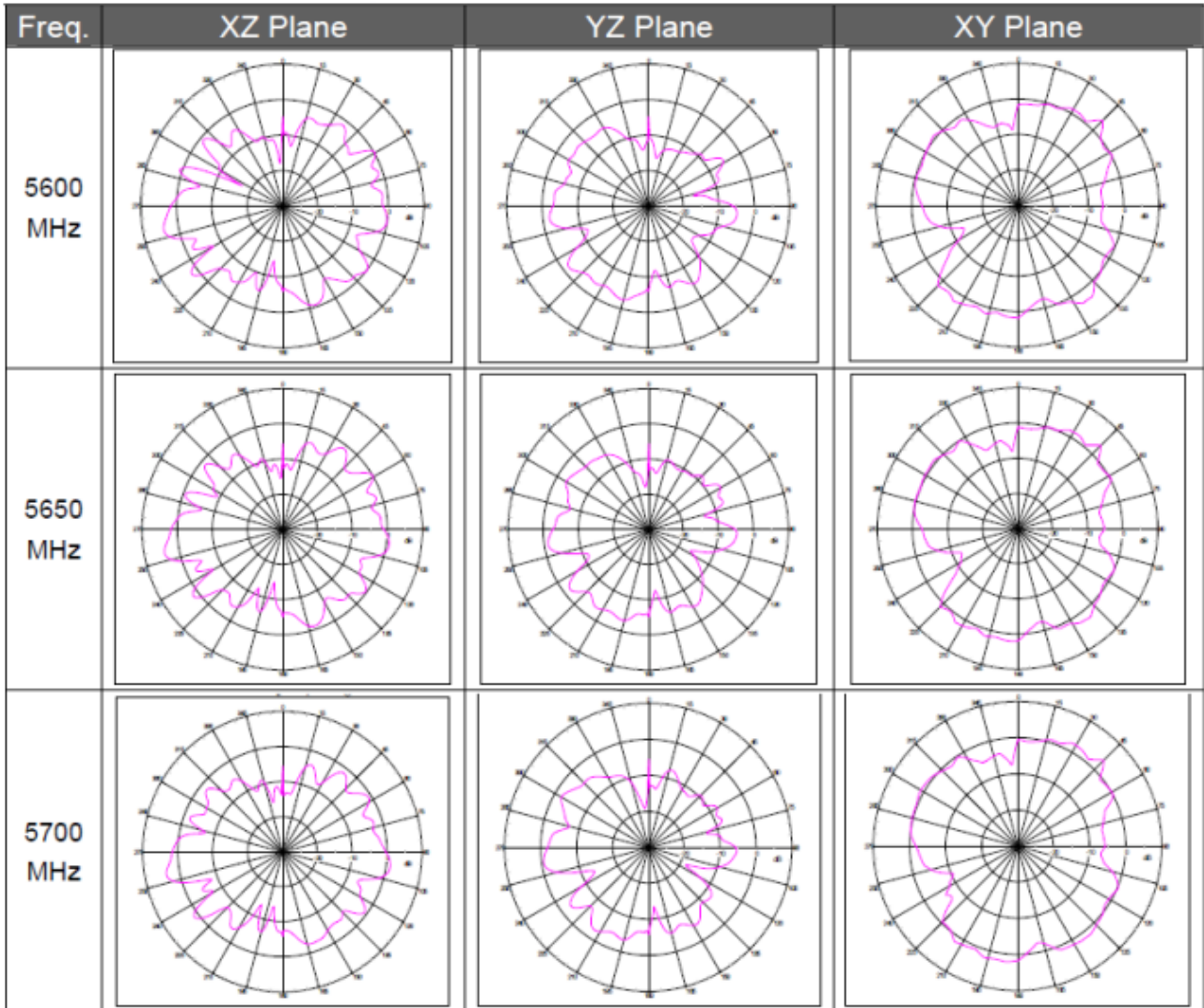

Wi-Fi Antenna Radiation Patterns (con.)

Measured with glass

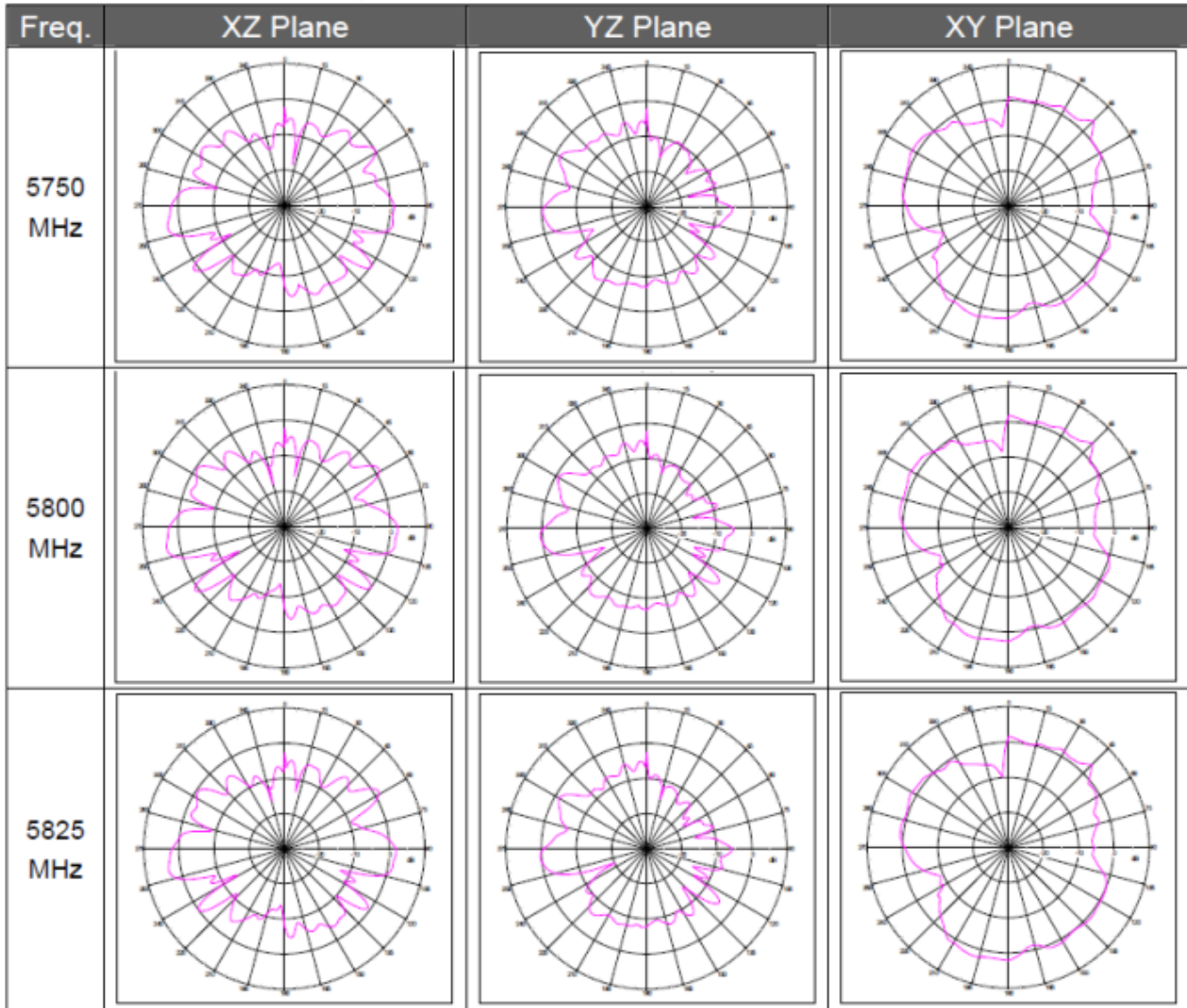

Wi-Fi Antenna Radiation Patterns (con.)
 Measured with glass

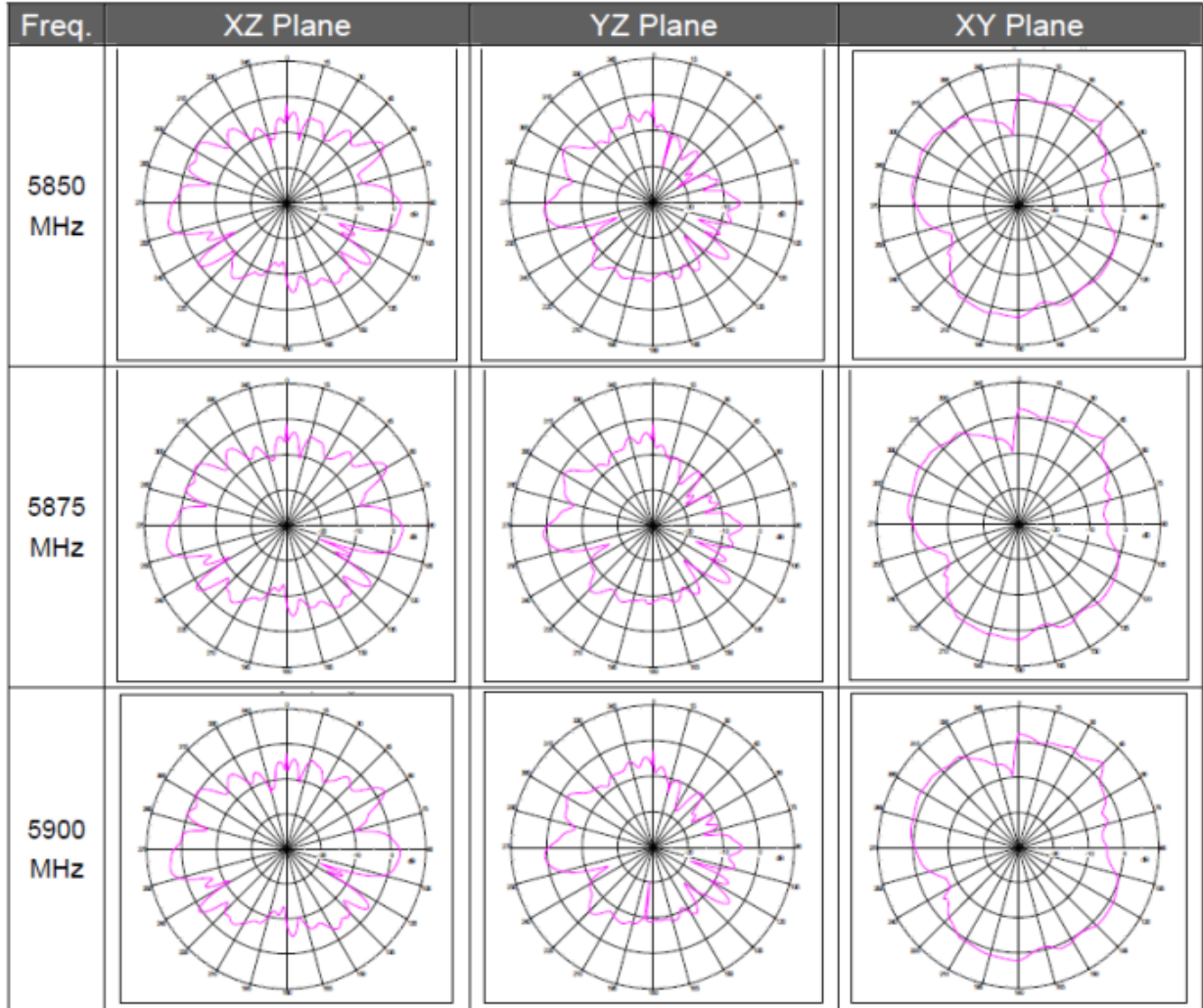

Wi-Fi Antenna Radiation Patterns (con.)

(Measured with glass)

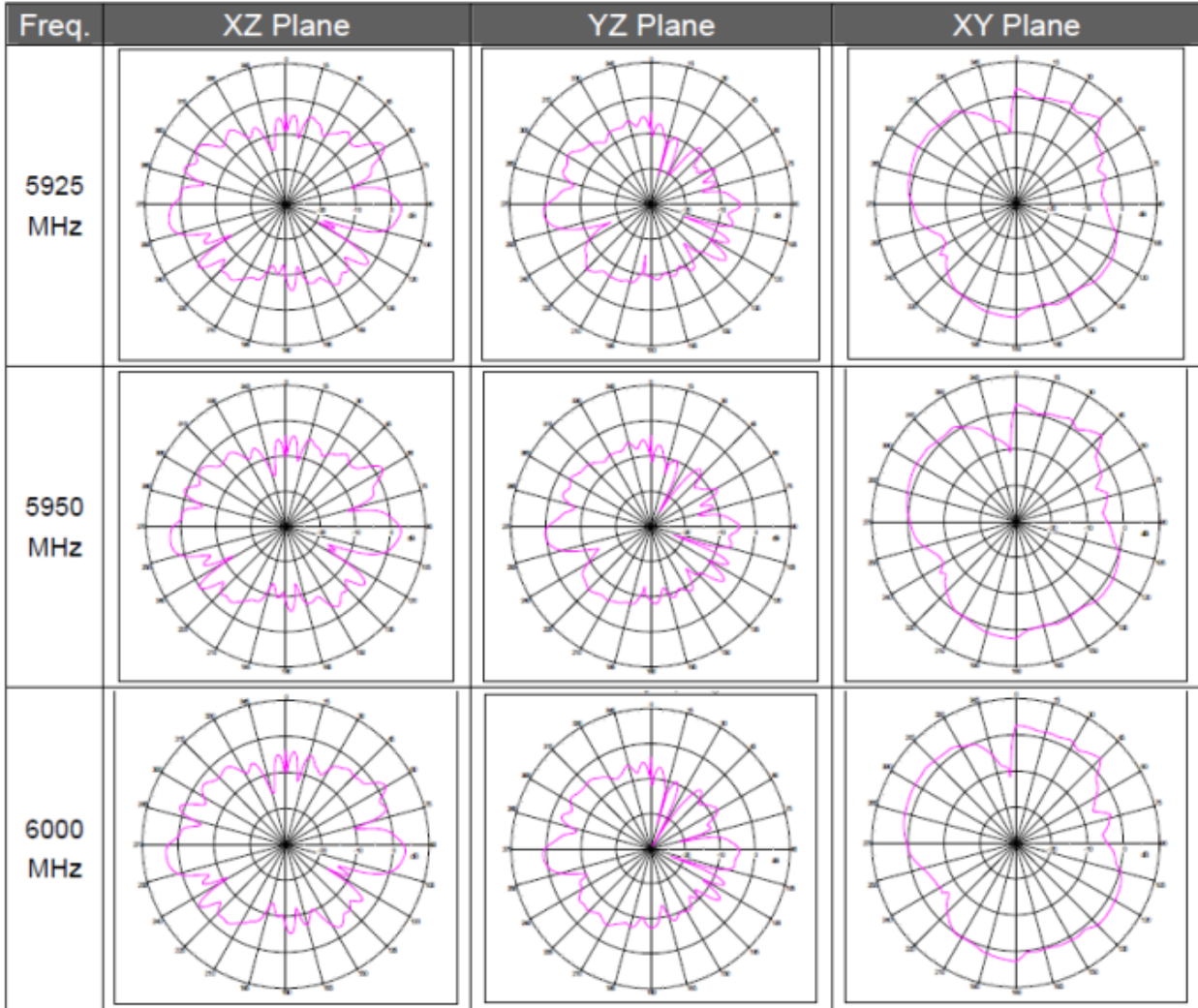

5. Packaging

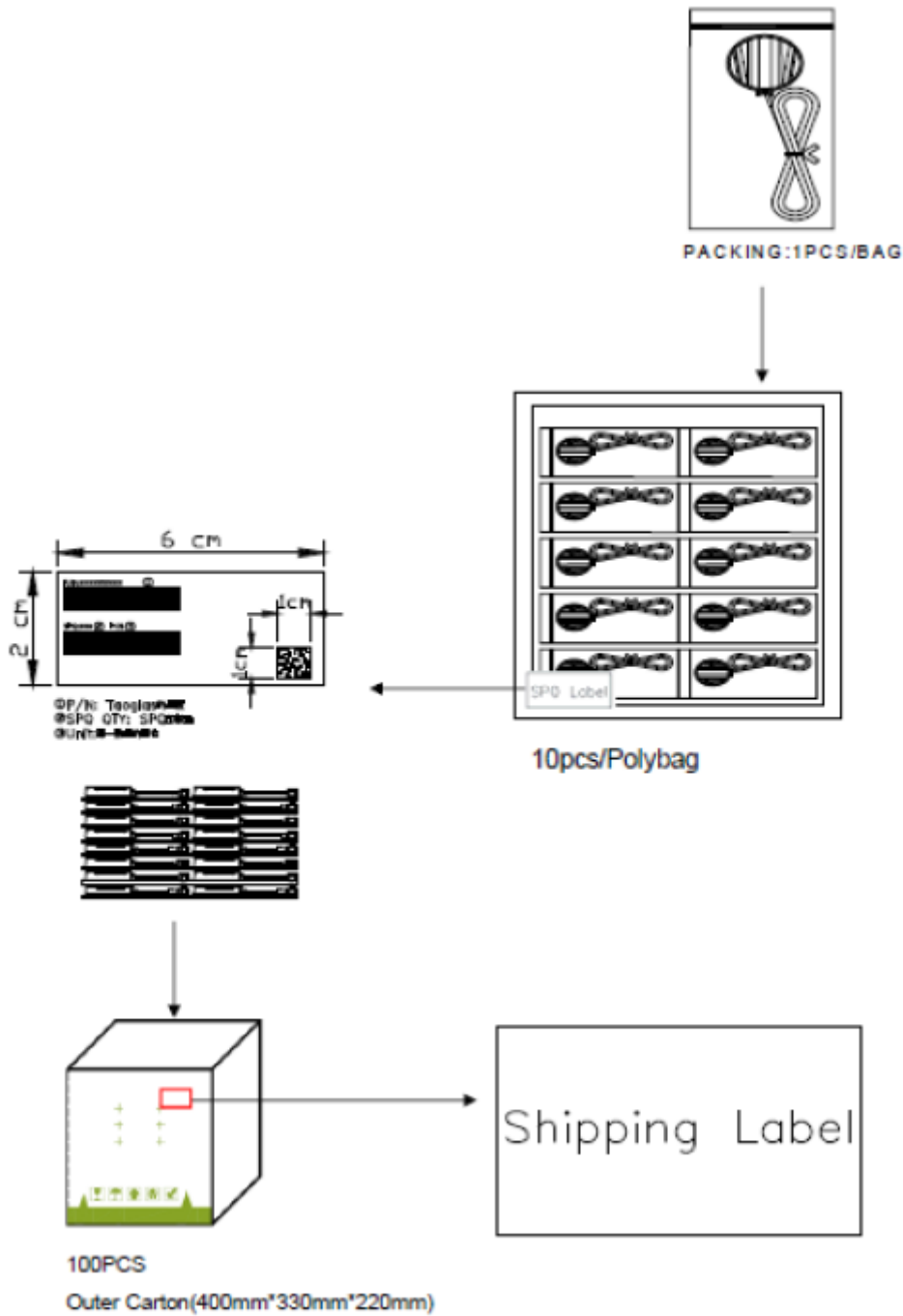



Taoglas makes no warranties based on the accuracy or completeness of the contents of this document and reserves the right to make changes to specifications and product descriptions at any time without notice. Taoglas reserves all rights to this document and the information contained herein.

Reproduction, use or disclosure to third parties without express permission is strictly prohibited.

Copyright © Taoglas Ltd.