

KIT P/N	HOUSING COLOR
106073-0020	BLACK
106073-0024	CLEAR

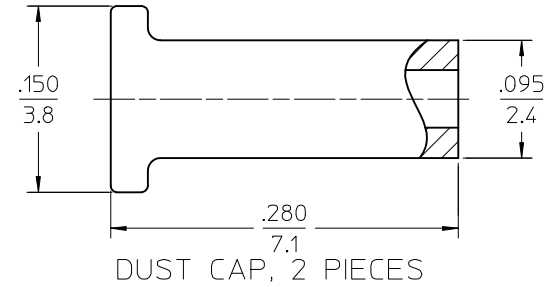

HOUSING (SCALE 8:1)

DUST CAP, 2 PIECES

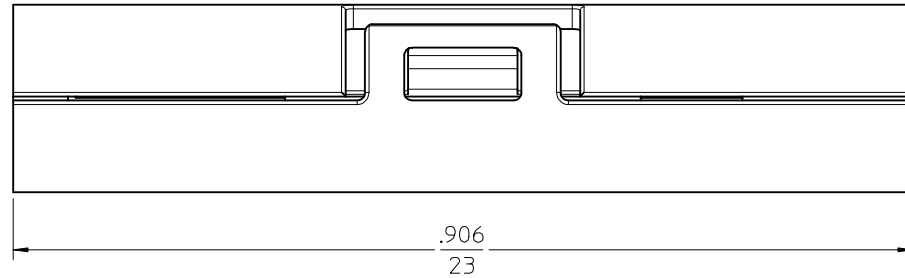
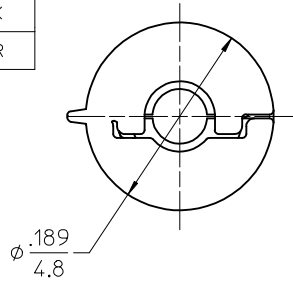
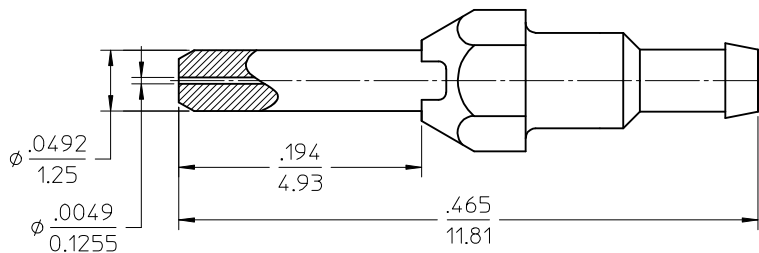

LC PLUG, METAL BODY, 2 PIECES
(ZIRCONIA CERAMIC FERRULE)

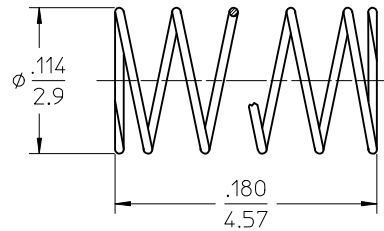

COMPRESSION SPRING
(MUSIC WIRE)

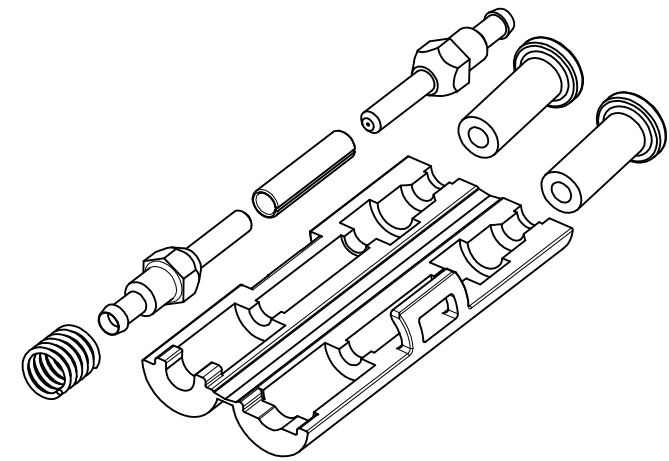

ISOMETRIC VIEW
SCALE 4:1

NOTES:

1. ALL DIMENSIONS ARE FOR REFERENCE ONLY.
2. ALL PARTS ARE PACKED IN ONE BAG - 1 KIT PER BAG.
3. ALL PLASTIC MATERIALS ARE UL-94 V-0 RATED.

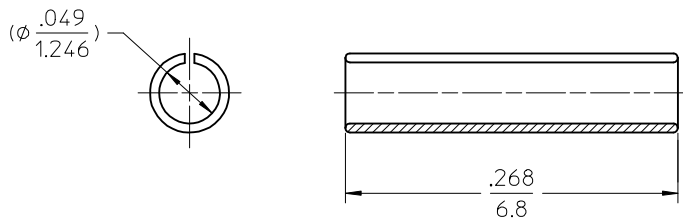

ALIGNMENT SLEEVE
(ZIRCONIA CERAMIC)

ENTER DESCRIPTION EC NO: MF2009-0559 DRWN: YBEDNYAK 2009/04/21 CHKD: 2009/04/21 APPR: LGUMIN 2009/04/21	QUALITY SYMBOLS ▽=0 ▽=0	GENERAL TOLERANCES (UNLESS SPECIFIED) mm INCH 4 PLACES ± --- ± --- 3 PLACES ± --- ± --- 2 PLACES ± --- ± --- 1 PLACE ± --- ± --- ANGULAR ±1/2°	DIMENSION STYLE IN/MM DRAWN BY DATE KP 01/25/2006 CHECKED BY DATE	SCALE 10:1 DESIGN UNITS INCH THIRD ANGLE PROJECTION	TITLE SNAP MATE KIT (FULL)	
	DRAFT WHERE APPLICABLE MUST REMAIN WITHIN DIMENSIONS		APPROVED BY DATE I. GUMIN 01/25/2006	MOLEX INCORPORATED		
	MATERIAL NO. SEE TABLE		DOCUMENT NO. SD-106073-0020	SHEET NO. 1 OF 1		
	THIS DRAWING CONTAINS INFORMATION THAT IS PROPRIETARY TO MOLEX INCORPORATED AND SHOULD NOT BE USED WITHOUT WRITTEN PERMISSION					