



## GaAs MMIC I/Q UPCONVERTER 10 - 16 GHz

### Typical Applications

The HMC924LC5 is ideal for:

- Point-to-Point and Point-to-Multi-Point Radio
- Military Radar, EW & ELINT
- Satellite Communications
- Sensors

### Features

- High Conversion Gain: 15 dB
- Excellent Sideband Rejection: -30 dBc
- LO / RF Rejection: 15 dBc
- High Input IP3: 14 dBm
- 32 Lead 5 x 5 mm SMT Ceramic Package: 25 mm<sup>2</sup>

### Functional Diagram

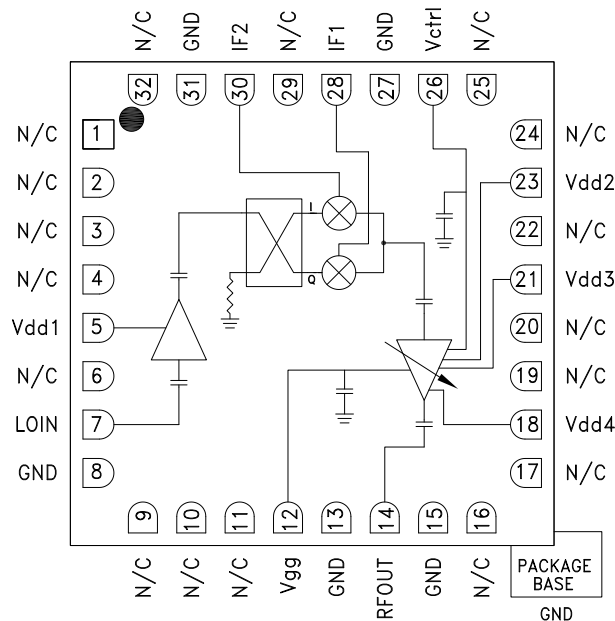

### General Description

The HMC924LC5 is a compact GaAs MMIC I/Q upconverter in a leadless RoHS compliant SMT package. This device provides a small signal conversion gain of 15 dB with -30 dBc of sideband rejection. The HMC924LC5 utilizes a RF amplifier preceded by an I/Q mixer where the LO is driven by a driver amplifier. IF1 and IF2 mixer inputs are provided and an external 90° hybrid is needed to select the required sideband. The I/Q mixer topology reduces the need for filtering of the unwanted sideband. The HMC924LC5 is a much smaller alternative to hybrid style single sideband upconverter assemblies and it eliminates the need for wire bonding by allowing the use of surface mount manufacturing techniques.

### Electrical Specifications, $T_A = +25^\circ\text{C}$ , IF = 2000 MHz, IF = -6 dBm, LO = 0 dBm, Vdd1, 4 = +5V, USB <sup>[1][2]</sup>

Parameter	Min.	Typ.	Max.	Min.	Typ.	Max.	Units
Frequency Range, RF		10 - 13			13 - 16		GHz
Frequency Range, LO		7 - 16			10 - 19		GHz
Frequency Range, IF		0 - 3			0 - 3		GHz
Conversion Gain	14	17			15		dB
Sideband Rejection		-30			-20		dBc
1 dB Compression (Output)	19	22		19	22		dBm
LO to RF Rejection <sup>[3]</sup>		15			15		dB
IP3 (Output) at Max Gain		29			27		dBm
Supply Current Idd1 + Idd2 + Idd3 + Idd4 <sup>[2]</sup>		290			290		mA

[1] Unless otherwise noted all measurements performed with low side LO, IF = 2000 MHz and external IF 90° hybrid.

[2] Adjust Vgg between -2 to 0V to achieve Idd2 + Idd3 + Idd4 = 170 mA Typical.

[3] The LO / RF Rejection is defined as the LO signal level at the RF output port relative to the desired RF output signal level.

# HMC924\* PRODUCT PAGE QUICK LINKS

Last Content Update: 02/23/2017

---

## COMPARABLE PARTS

View a parametric search of comparable parts.

## EVALUATION KITS

- HMC924LC5 Evaluation Board

## DOCUMENTATION

### Data Sheet

- HMC924 Data Sheet

## REFERENCE MATERIALS

### Quality Documentation

- Package/Assembly Qualification Test Report: LC5, LC5A (QTR: 2014-00384 REV: 01)
- Semiconductor Qualification Test Report: PHEMT-F (QTR: 2013-00269)

## DESIGN RESOURCES

- HMC924 Material Declaration
- PCN-PDN Information
- Quality And Reliability
- Symbols and Footprints

## DISCUSSIONS

View all HMC924 EngineerZone Discussions.

## SAMPLE AND BUY

Visit the product page to see pricing options.

## TECHNICAL SUPPORT

Submit a technical question or find your regional support number.

## DOCUMENT FEEDBACK

Submit feedback for this data sheet.

---



**GaAs MMIC I/Q UPCONVERTER  
10 - 16 GHz**

**Data Taken as SSB Upconverter with External IF 90° Hybrid, IF = 2000 MHz**

**Conversion Gain, USB vs. Temperature**

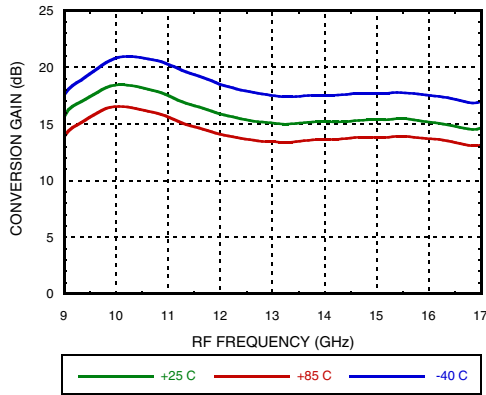

**Conversion Gain, USB vs. LO Drive**

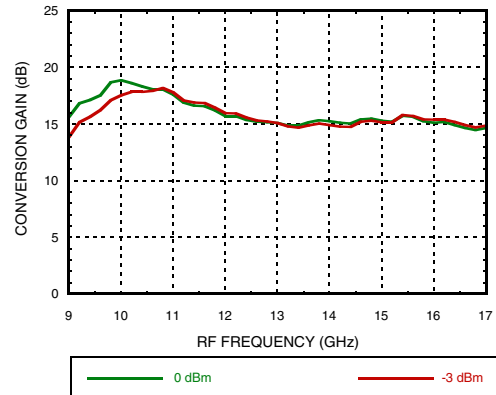

**RF Return Loss vs. Temperature**

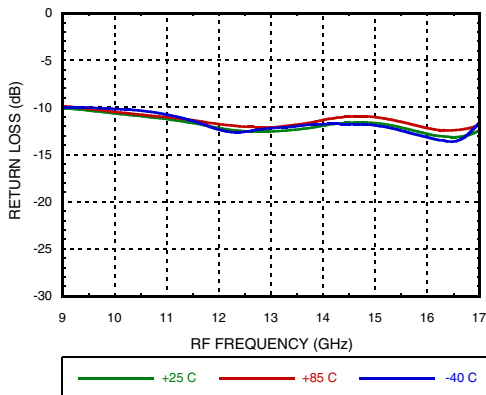

**LO Return Loss vs. Temperature**

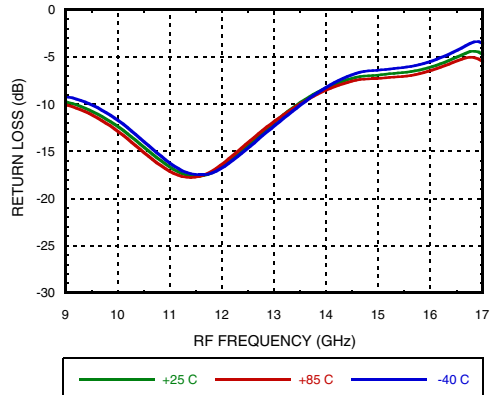

**IF Return Loss [1]**

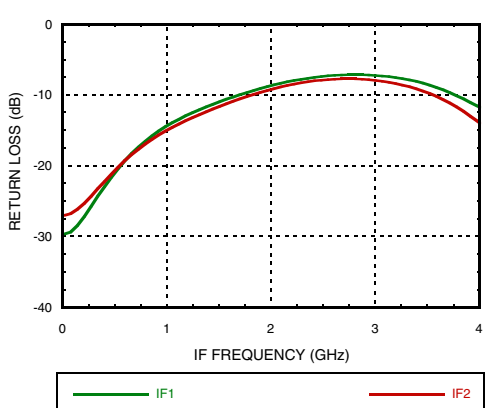

**Side Band Rejection, USB vs. Temperature**

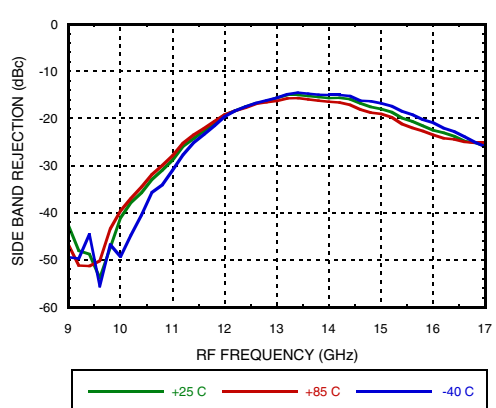

[1] Data taken without external IF 90° hybrid



**GaAs MMIC I/Q UPCONVERTER  
10 - 16 GHz**

*Data Taken as SSB Upconverter with External IF 90° Hybrid, IF = 2000 MHz*

**Input P1dB, USB vs. Temperature**

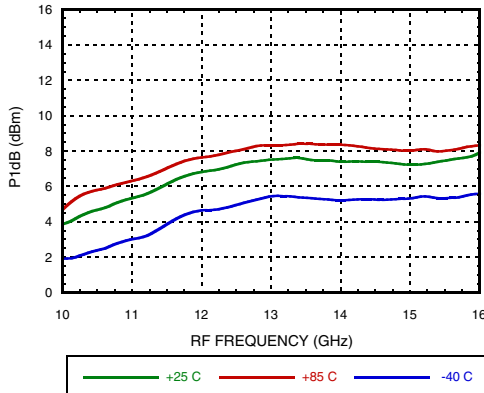

**Output P1dB, USB vs. Temperature**

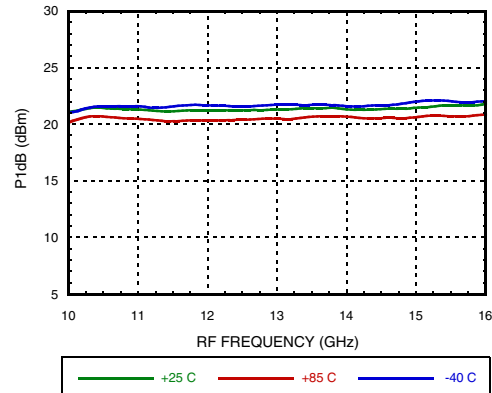

**Input IP3, USB vs. Temperature**

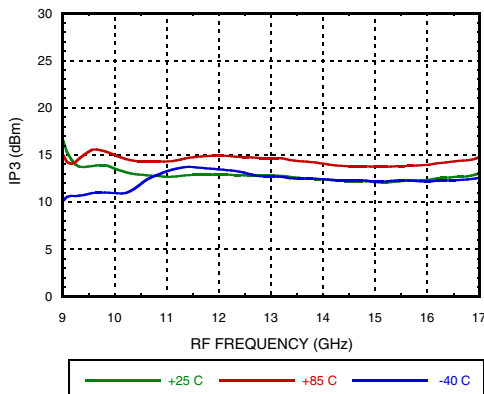

**Output IP3, USB vs. Temperature**

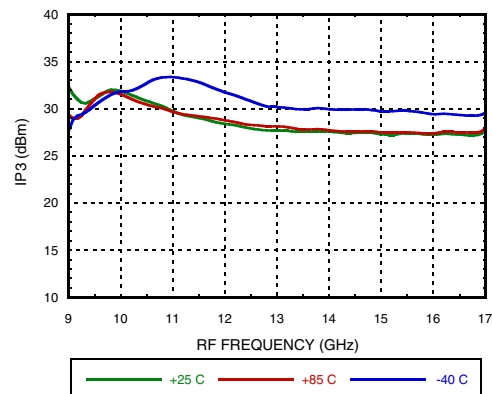

**Conversion Gain, USB vs. Control Voltage**

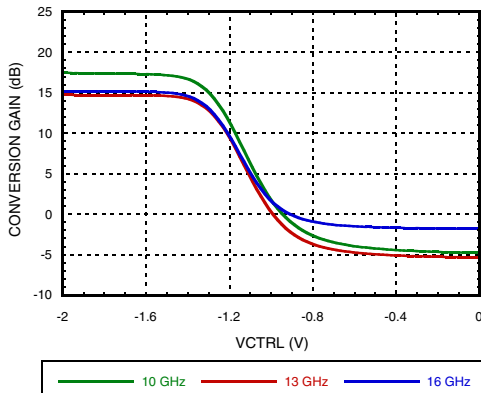

**Input IP3, USB vs. Control Voltage**

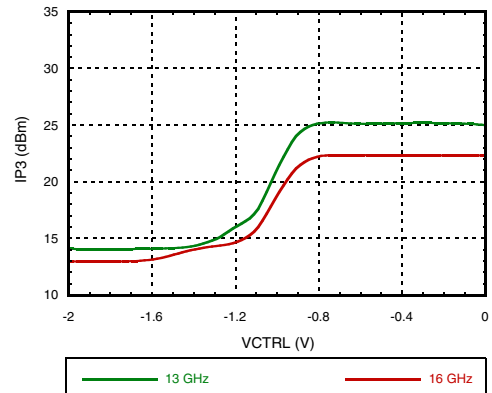

Information furnished by Analog Devices is believed to be accurate and reliable. However, no responsibility is assumed by Analog Devices for its use, nor for any infringements of patents or other rights of third parties that may result from its use. Specifications subject to change without notice. No license is granted by implication or otherwise under any patent or patent rights of Analog Devices. Trademarks and registered trademarks are the property of their respective owners.

For price, delivery, and to place orders: Analog Devices, Inc., One Technology Way, P.O. Box 9106, Norwood, MA 02062-9106 Phone: 781-329-4700 • Order online at [www.analog.com](http://www.analog.com) Application Support: Phone: 1-800-ANALOG-D



**GaAs MMIC I/Q UPCONVERTER  
10 - 16 GHz**

**Data Taken as SSB Upconverter with External IF 90° Hybrid, IF = 2000 MHz**

**LO / RF Rejection, USB vs. Temperature**

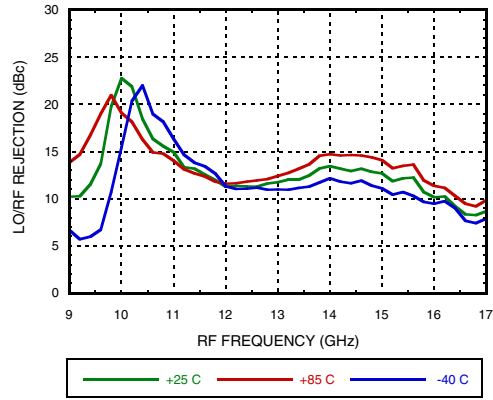

**Isolation**

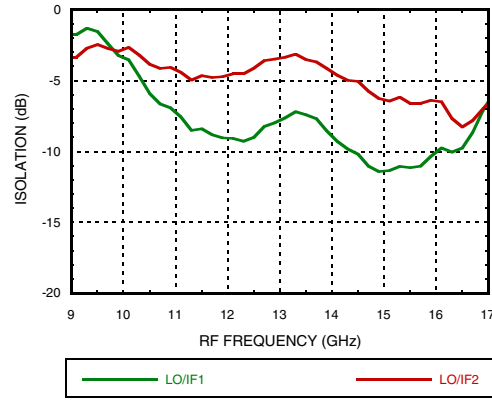

[1] Data taken without external IF 90° hybrid



**GaAs MMIC I/Q UPCONVERTER  
10 - 16 GHz**

*Data Taken as SSB Upconverter with External IF 90° Hybrid, IF = 2000 MHz*

**Conversion Gain, LSB vs. Temperature**

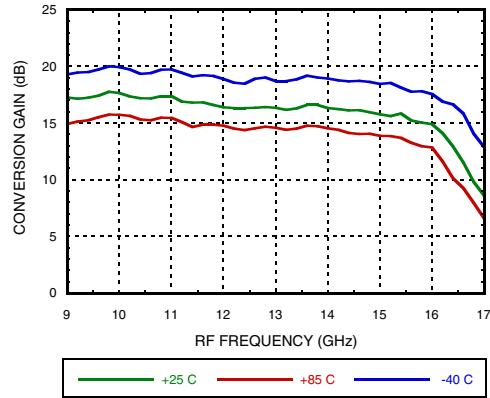

**Conversion Gain, LSB vs. LO Drive**

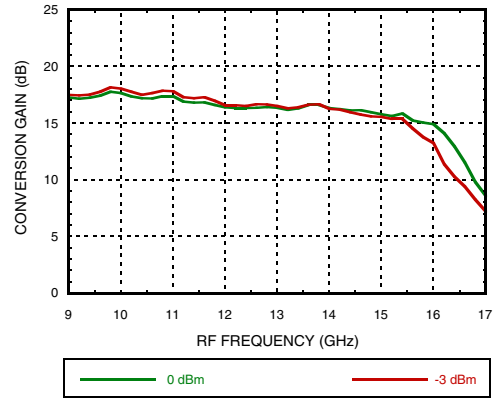

**Sideband Rejection, LSB vs. Temperature**

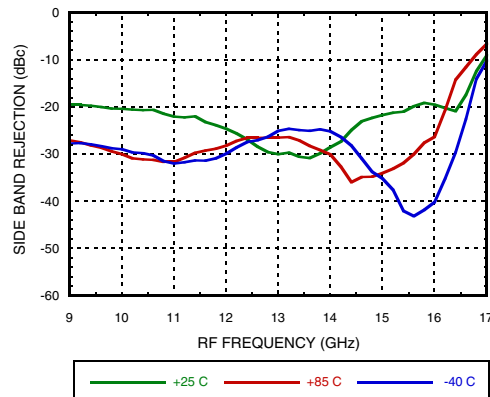

**Input P1dB, LSB vs. Temperature**

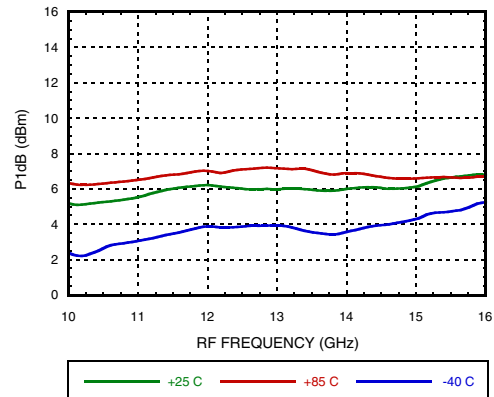

**Output P1dB, LSB vs. Temperature**

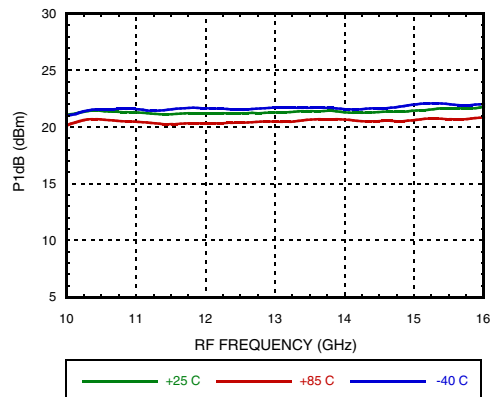

**Input IP3, LSB vs. Temperature**

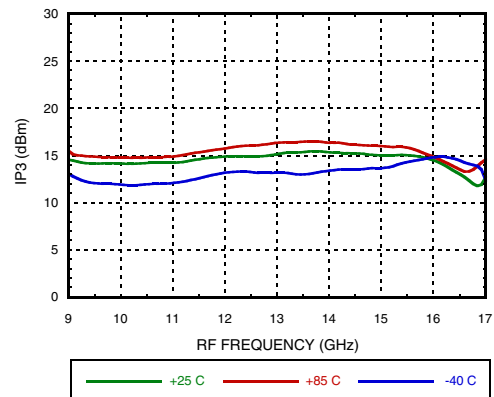

Information furnished by Analog Devices is believed to be accurate and reliable. However, no responsibility is assumed by Analog Devices for its use, nor for any infringements of patents or other rights of third parties that may result from its use. Specifications subject to change without notice. No license is granted by implication or otherwise under any patent or patent rights of Analog Devices. Trademarks and registered trademarks are the property of their respective owners.

For price, delivery, and to place orders: Analog Devices, Inc., One Technology Way, P.O. Box 9106, Norwood, MA 02062-9106 Phone: 781-329-4700 • Order online at [www.analog.com](http://www.analog.com) Application Support: Phone: 1-800-ANALOG-D



**GaAs MMIC I/Q UPCONVERTER  
10 - 16 GHz**

*Data Taken as SSB Upconverter with External IF 90° Hybrid, IF = 2000 MHz*

**Output IP3, LSB vs. Temperature**

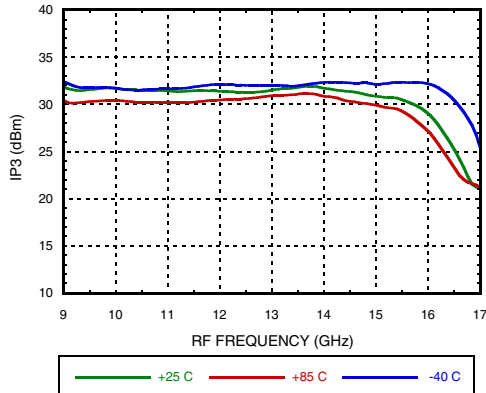

**Conversion Gain, LSB vs. Control Voltage**

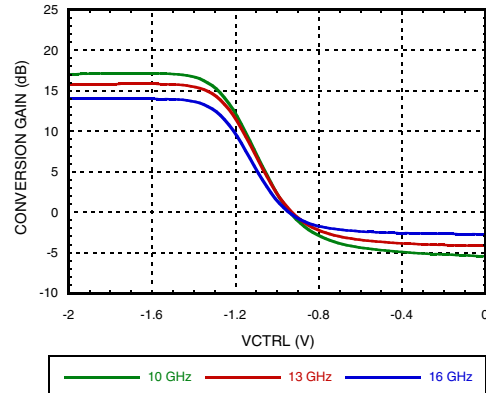

**LO/RF Rejection, LSB**

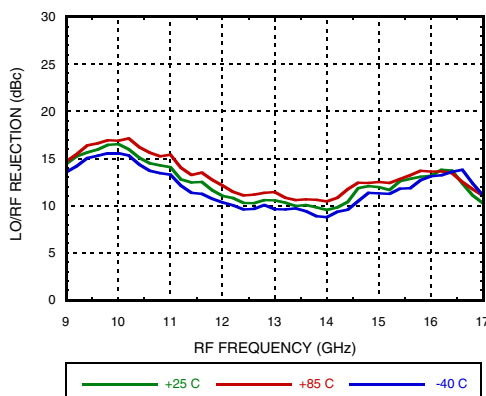

**Input IP3, LSB vs. Control Voltage**

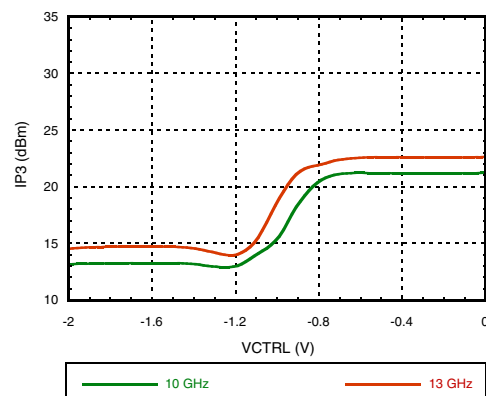

Information furnished by Analog Devices is believed to be accurate and reliable. However, no responsibility is assumed by Analog Devices for its use, nor for any infringements of patents or other rights of third parties that may result from its use. Specifications subject to change without notice. No license is granted by implication or otherwise under any patent or patent rights of Analog Devices. Trademarks and registered trademarks are the property of their respective owners.

For price, delivery, and to place orders: Analog Devices, Inc., One Technology Way, P.O. Box 9106, Norwood, MA 02062-9106 Phone: 781-329-4700 • Order online at [www.analog.com](http://www.analog.com) Application Support: Phone: 1-800-ANALOG-D



**GaAs MMIC I/Q UPCONVERTER  
10 - 16 GHz**

*Data Taken as SSB Upconverter with External IF 90° Hybrid, IF = 3000 MHz*

**Conversion Gain, USB vs. Temperature**

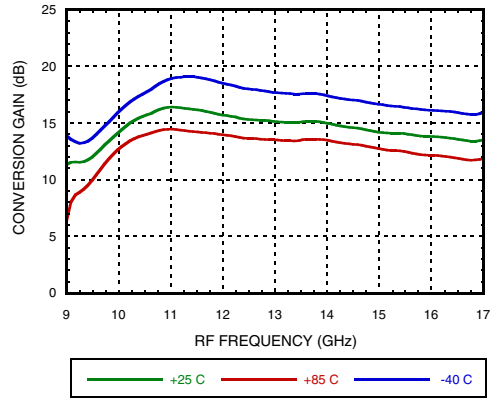

**Conversion Gain, USB vs. LO Drive**

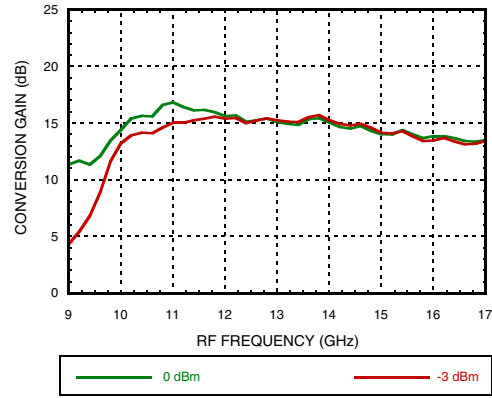

**Sideband Rejection, USB vs. Temperature**

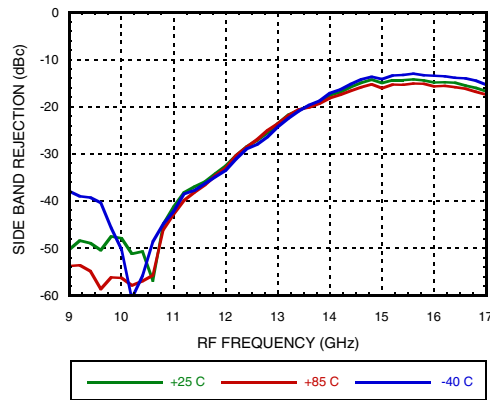

**Input P1dB, USB vs. Temperature**

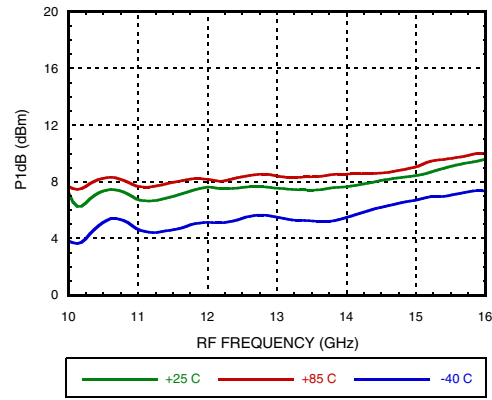

**Output P1dB, USB vs. Temperature**

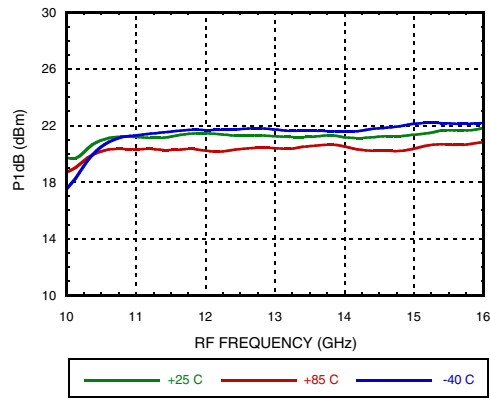

**Input IP3, USB vs. Temperature**

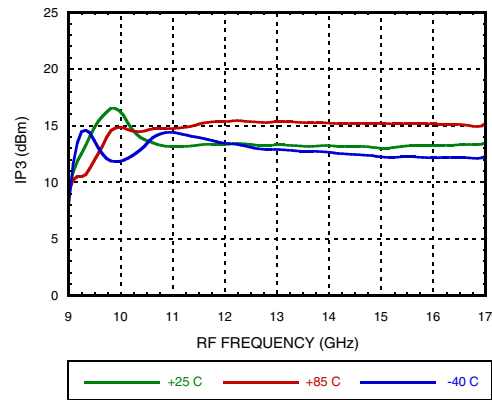

Information furnished by Analog Devices is believed to be accurate and reliable. However, no responsibility is assumed by Analog Devices for its use, nor for any infringements of patents or other rights of third parties that may result from its use. Specifications subject to change without notice. No license is granted by implication or otherwise under any patent or patent rights of Analog Devices. Trademarks and registered trademarks are the property of their respective owners.

For price, delivery, and to place orders: Analog Devices, Inc., One Technology Way, P.O. Box 9106, Norwood, MA 02062-9106 Phone: 781-329-4700 • Order online at [www.analog.com](http://www.analog.com) Application Support: Phone: 1-800-ANALOG-D





**GaAs MMIC I/Q UPCONVERTER  
10 - 16 GHz**

*Data Taken as SSB Upconverter with External IF 90° Hybrid, IF = 3000 MHz*

**Output IP3, USB vs. Temperature**

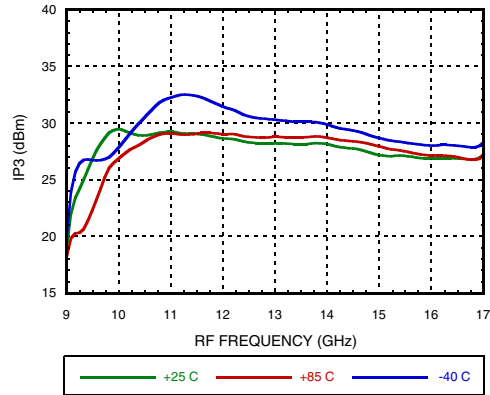

**Conversion Gain, USB vs. Control Voltage**

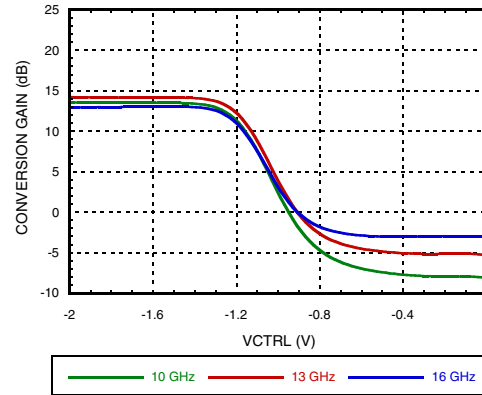

**LO/RF Rejection, USB vs. Temperature**

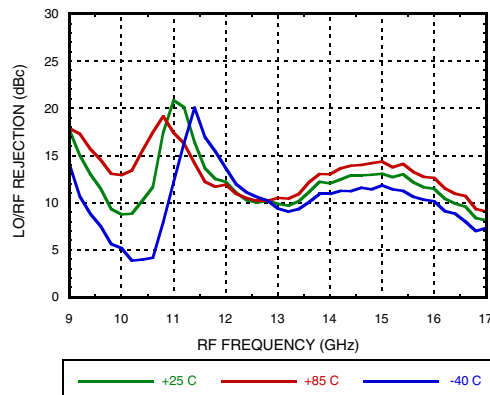

**Input IP3, USB vs. Control Voltage**

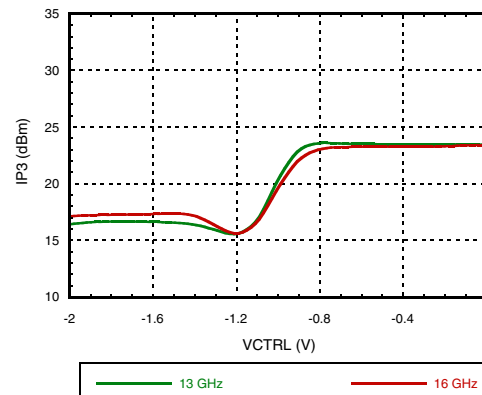



**GaAs MMIC I/Q UPCONVERTER  
10 - 16 GHz**

*Data Taken as SSB Upconverter with External IF 90° Hybrid, IF = 3000 MHz*

**Conversion Gain, LSB vs. Temperature**

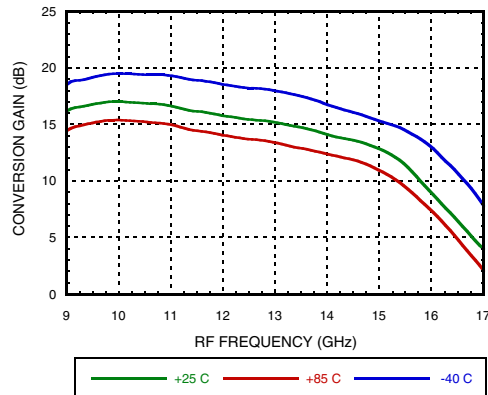

**Conversion Gain, LSB vs. LO Drive**

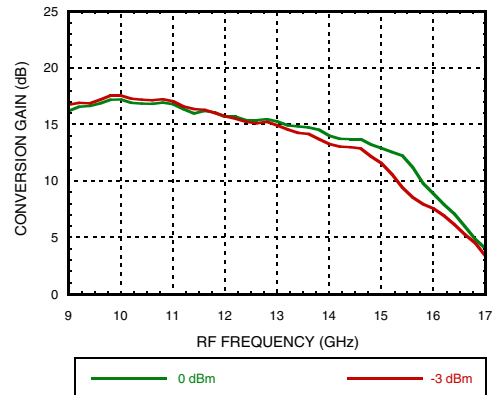

**Sideband Rejection, LSB vs. Temperature**

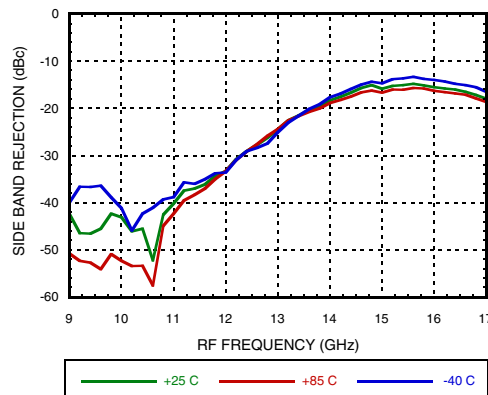

**Input P1dB, LSB vs. Temperature**

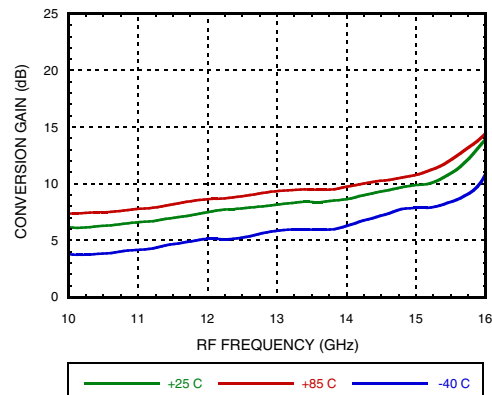

**Output P1dB, LSB vs. Temperature**

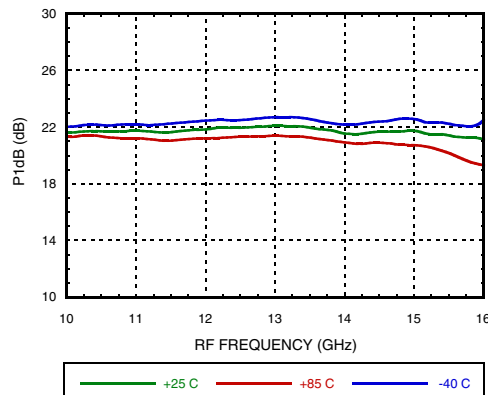

**Input IP3, LSB vs. Temperature**

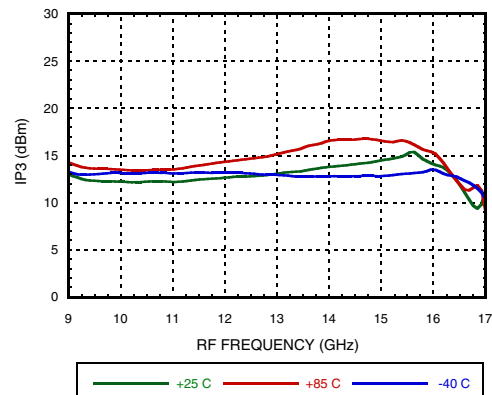

Information furnished by Analog Devices is believed to be accurate and reliable. However, no responsibility is assumed by Analog Devices for its use, nor for any infringements of patents or other rights of third parties that may result from its use. Specifications subject to change without notice. No license is granted by implication or otherwise under any patent or patent rights of Analog Devices. Trademarks and registered trademarks are the property of their respective owners.

For price, delivery, and to place orders: Analog Devices, Inc., One Technology Way, P.O. Box 9106, Norwood, MA 02062-9106 Phone: 781-329-4700 • Order online at [www.analog.com](http://www.analog.com) Application Support: Phone: 1-800-ANALOG-D



**GaAs MMIC I/Q UPCONVERTER  
10 - 16 GHz**

*Data Taken as SSB Upconverter with External IF 90° Hybrid, IF = 3000 MHz*

**Output IP3, LSB vs. Temperature**

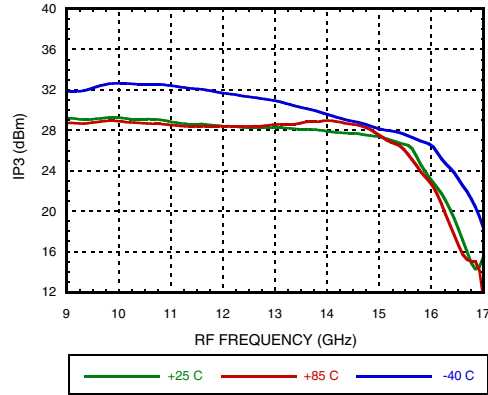

**Conversion Gain, LSB vs. Control Voltage**

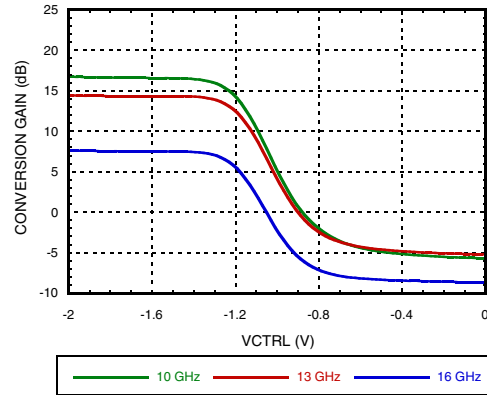

**LO/RF Rejection, LSB vs. Temperature**

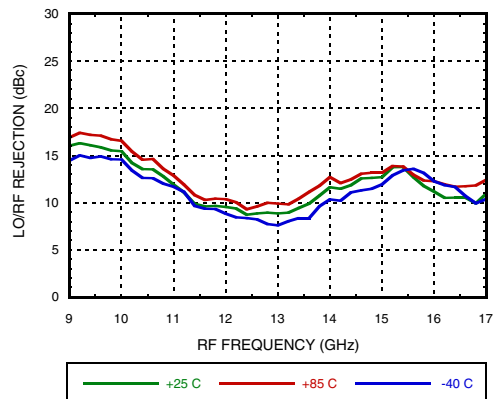

**Input IP3, USB vs. Control Voltage**

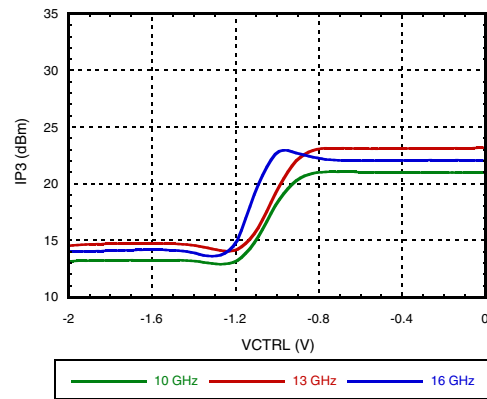



## GaAs MMIC I/Q UPCONVERTER 10 - 16 GHz

### MxN Spurious Outputs [1][2]

mIF	nLO				
	0	1	2	3	4
0	x	-6.4	-40.2	xx	xx
1	-54.2	0	-47.2	-73.2	xx
2	-40.2	-47.2	-45.0	-82.2	xx
3	-67.2	-49.2	-74.2	-75.2	xx
4	-69.2	-78.2	-74.2	-85.2	xx

IF = 2.0 GHz @ -10 dBm  
LO = 16.9 GHz @ 0 dBm

### MxN Spurious Outputs [1][2]

mIF	nLO				
	0	1	2	3	4
0	0	-5.0	-46.3	-63.3	xx
1	-50.3	0	-45.3	-58.3	xx
2	-42.3	-40.3	-46.3	-63.3	xx
3	-64.3	-49.3	-70.2	-68.3	xx
4	-71.3	-76.3	-78.3	-89.3	xx

IF = 2.6 GHz @ -10 dBm  
LO = 15 GHz @ 0 dBm

### MxN Spurious Outputs [1][3]

mIF	nLO				
	0	1	2	3	4
0	x	-13	-35.1	-68.1	xx
1	-74.1	0	-52.1	-58.1	xx
2	-38.1	-42.1	-46.1	-71.1	xx
3	-87.1	-50.1	-79.1	-75.1	xx
4	-67.1	-94.1	-77.1	xx	xx

IF = 2 GHz @ -10 dBm  
LO = 12.9 GHz @ 0 dBm

### MxN Spurious Outputs [1][3]

mIF	nLO				
	0	1	2	3	4
0	x	-8.0	-21.8	-54.8	-66.8
-1	-51.8	0	-39.8	-60.8	-87.8
-2	-41.8	-40.8	-46.8	-67.8	-93.8
-3	-66.8	-52.8	-71.8	-69.8	-91.8
-4	-70.8	-77.8	-79.8	-86.8	xx

IF = 2 GHz @ -10 dBm  
LO = 9.1 GHz @ 0 dBm

### Absolute Maximum Ratings

IF Input	+20 dBm
LO Input	+10 dBm
Channel Temperature	175 °C
Continuous Pdiss (T = 85 °C) (derate 18.3 mW/°C above 85 °C)	1.65 W
Thermal Resistance (channel to ground paddle)	54.6 °C/W
Storage Temperature	-65 to +150 °C
Operating Temperature	-40 to +85 °C



ELECTROSTATIC SENSITIVE DEVICE  
OBSERVE HANDLING PRECAUTIONS

[1] Data taken without external IF 90° hybrid

[2] All values in dBc below IF power level (LO - IF) LSB

[3] All values in dBc above IF power level (LO + IF) USB



### Outline Drawing

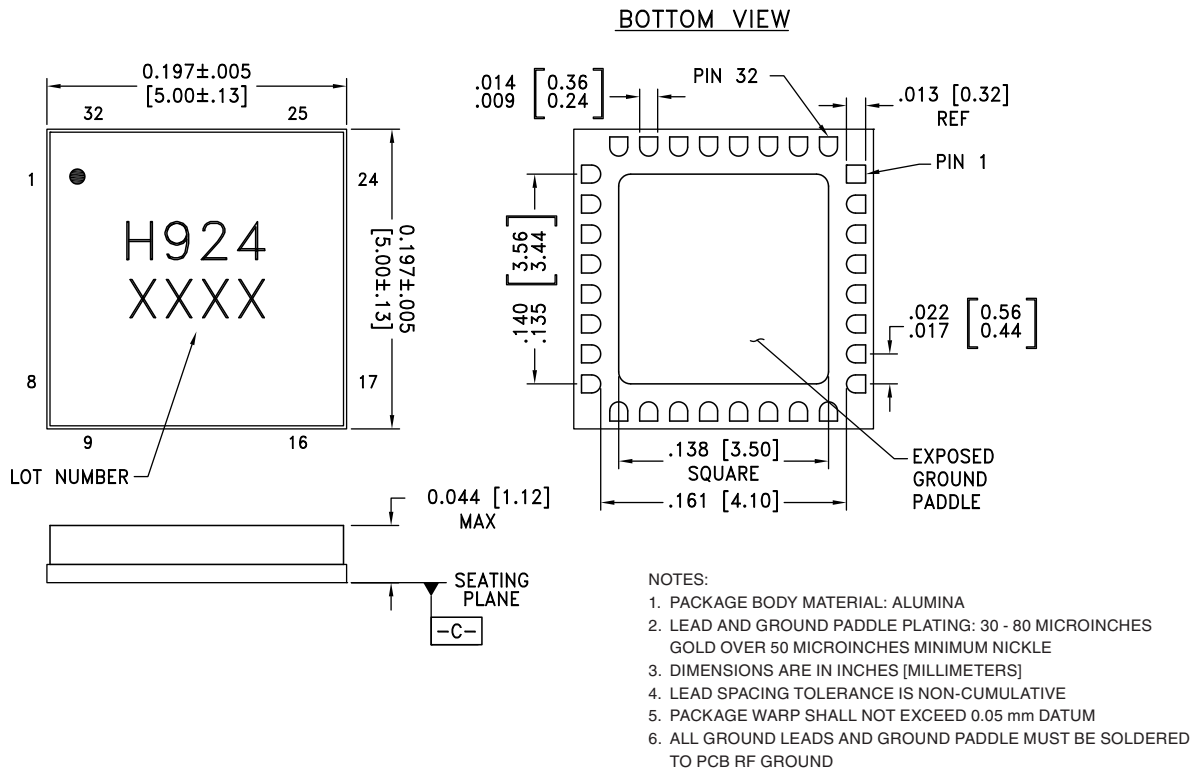

### Package Information

Part Number	Package Body Material	Lead Finish	MSL Rating	Package Marking <sup>[2]</sup>
HMC924LC5	Alumina, White	Gold over Nickel	MSL3 <sup>[1]</sup>	H924 XXXX

[1] Max peak reflow temperature of 260 °C

[2] 4-Digit lot number XXXX



### Pin Descriptions

Pin Number	Function	Description	Interface Schematic
1 - 4, 6, 9 - 11, 16, 17, 19, 20, 22, 24, 25, 29, 32	N/C	No connection required. The pins are not connected internally; however, all data shown herein was measured with these pins connected to RF/DC ground externally.	
5	Vdd1	Power supply voltage for LO amplifier. See application circuit for required external components.	
7	LOIN	This pin is AC coupled and matched to 50 Ohms.	
8, 13, 15, 27, 31	GND	These pins and package bottom must be connected to RF/DC ground.	
12	Vgg	Gate control for RF amplifier, please follow "MMIC Amplifier Biasing Procedure" application note. See application circuit for required external components.	
14	RFOUT	This pin is AC coupled and matched to 50 Ohms.	
18, 21, 23	Vdd4, Vdd3, Vdd2	Power supply voltage for RF amplifier. See application circuit for required external components.	
26	Vctl	Gain Control Voltage for RF Amplifier	
28	IF1	Differential IF input pins. For applications not requiring operation to DC, an off chip DC blocking capacitor should be used. For operation to DC this pin must not source/sink more than 3 mA of current or part non function and possible part failure will result.	
30	IF2		



**GaAs MMIC I/Q UPCONVERTER  
10 - 16 GHz**

**Typical Application**

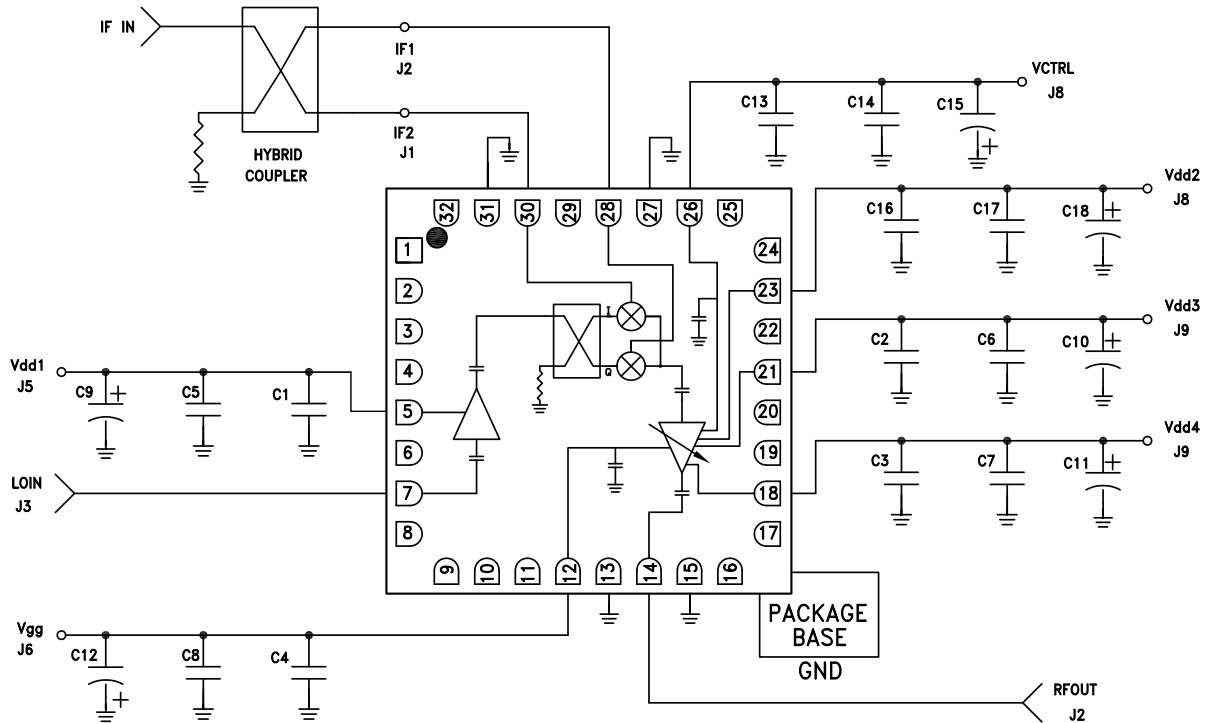

C1-C4, C13, C16	100 pF Capacitor, 0402 Pkg.
C5 - C8, C14, C17	1000 pF Capacitor, 0603 Pkg.
C9 - C12, C15, C18	2.2 $\mu$ F Capacitor, Case A Pkg.



**GaAs MMIC I/Q UPCONVERTER  
10 - 16 GHz**

**Evaluation PCB**

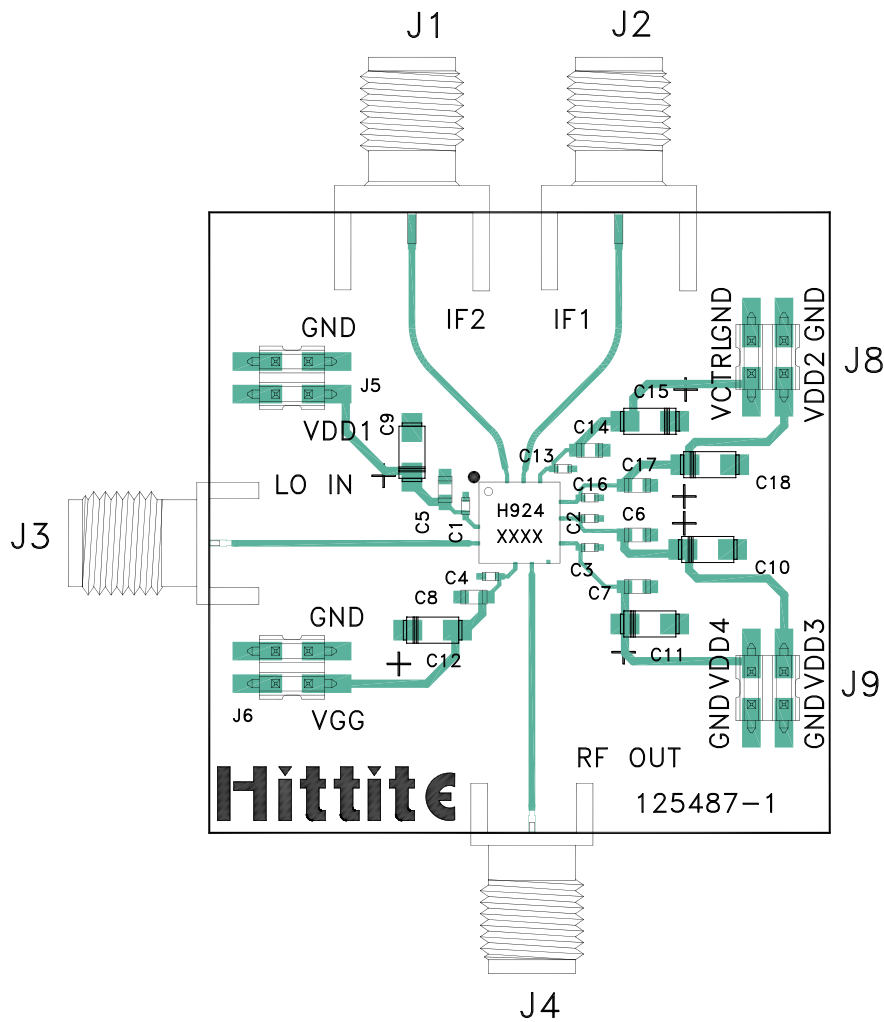

**List of Materials for Evaluation PCB 131092 [1]**

Item	Description
J1, J2	SMA Connector
J3, J4	K-Connector SRI
J5, J6, J8, J9	DC Pins
C1 - C4, C13, C16	100 pF Capacitor, 0402 Pkg.
C5 - C8, C14, C17	1000 pF Capacitor, 0603 Pkg.
C9 - C12, C15, C18	2.2 μF Capacitor, Case A
U1	HMC924LC5 Upconverter
PCB [2]	125487 Evaluation Board

[1] Reference this number when ordering complete evaluation PCB

[2] Circuit Board Material: Arlon 25FR, FR4 or Rogers 4350

The circuit board used in the application should use RF circuit design techniques. Signal lines should have 50 Ohm impedance while the package ground leads and exposed paddle should be connected directly to the ground plane similar to that shown. A sufficient number of via holes should be used to connect the top and bottom ground planes. The evaluation circuit board shown is available from Hittite upon request.



