



PART No. 1418N4SSM8

for more information visit  
[www.hammfg.com](http://www.hammfg.com)

Data subject to change without notice

Isometric drawing Not to Scale

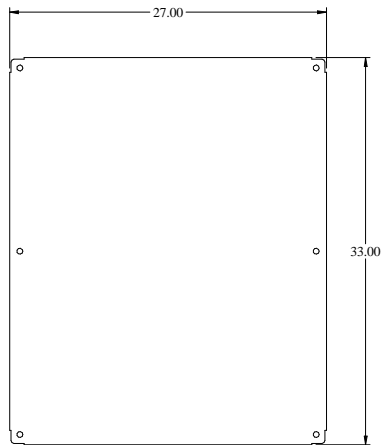

INNER PANEL

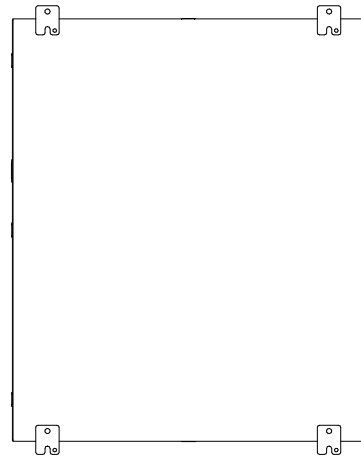

BACK VIEW

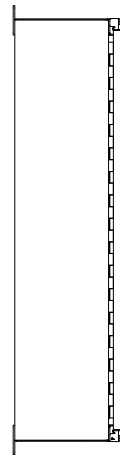

SIDE VIEW

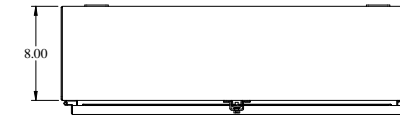

TOP VIEW

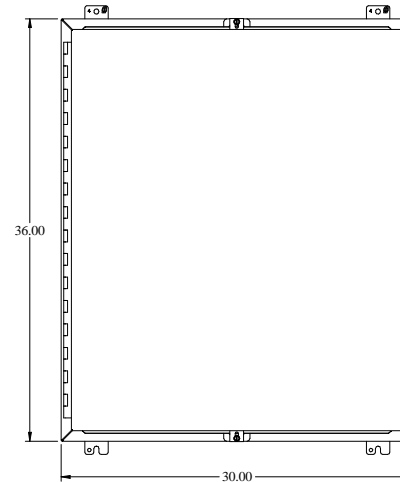

FRONT VIEW

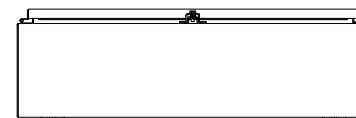

BOTTOM VIEW

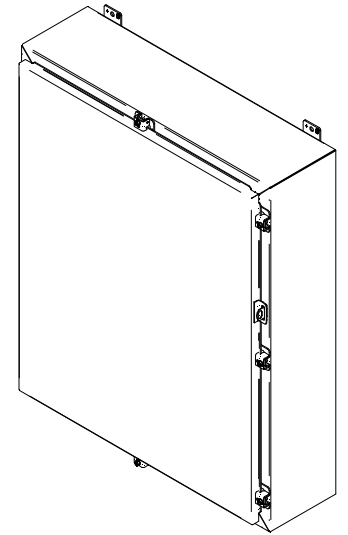

ISOMETRIC VIEW

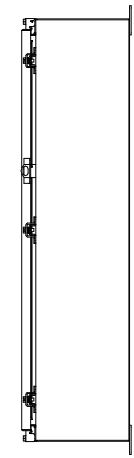

SIDE VIEW