

9-Output LED Driver with Intensity Control and Hot-Insertion Protection

General Description

The MAX6965 I²C-compatible serial interfaced peripheral provides microprocessors with nine additional output ports. Each output is an open-drain current-sinking output rated to 50mA at 7V. All outputs are capable of driving LEDs, or providing logic outputs with external resistive pullup up to 7V.

Eight-bit PWM current control is also integrated. Four of the bits are global control and apply to all LED outputs to provide coarse adjustment of current from fully off to fully on with 14 intensity steps. Additionally each output then has an individual 4-bit control, which further divides the globally set current into 16 more steps. Alternatively, the current control can be configured as a single 8-bit control that sets all outputs at once.

Each output has independent blink timing with two blink phases. LEDs can be individually set to be either on or off during either blink phase, or to ignore the blink control. The blink period is controlled by an external clock (up to 1kHz) on BLINK or by a register. The BLINK input can also be used as a logic control to turn the LEDs on and off, or as a general-purpose input (GPI).

The MAX6965 supports hot insertion. The SDA, SCL, $\overline{\text{RST}}$, BLINK, and the slave address input AD0 remain high impedance in power-down ($V_+ = 0V$) with up to 6V asserted upon them. The output ports remain high impedance with up to 8V asserted upon them.

The MAX6965 is controlled through a 2-wire I²C serial interface, and can be configured to one of four I²C addresses.

Applications

LCD Backlights
LED Status Indication
Keypad Backlights
RGB LED Drivers

Pin Configurations appear at end of data sheet.

Features

- ◆ 400kbps, 2-Wire Serial Interface, 5.5V Tolerant
- ◆ 2V to 3.6V Operation
- ◆ Overall 8-Bit PWM LED Intensity Control
Global 16-Step Intensity Control
Plus Individual 16-Step Intensity Controls
- ◆ Two-Phase LED Blinking
- ◆ High Port Output Current—Each Port 50mA (max)
- ◆ $\overline{\text{RST}}$ Input Clears Serial Interface and Restores Power-Up Default State
- ◆ Supports Hot Insertion
- ◆ Outputs are 7V-Rated Open Drain
- ◆ Low Standby Current (1.2 μ A (typ), 3.3 μ A (max))
- ◆ Tiny 3mm x 3mm, Thin QFN Package
- ◆ -40°C to +125°C Temperature Range

Ordering Information

PART	TEMP RANGE	PIN-PACKAGE	TOP MARK	PKG CODE
MAX6965ATE	-40°C to +125°C	16 Thin QFN 3mm x 3mm x 0.8mm	AAW	T1633-4
MAX6965AEE	-40°C to	16 QSOP	—	—

Typical Application Circuit

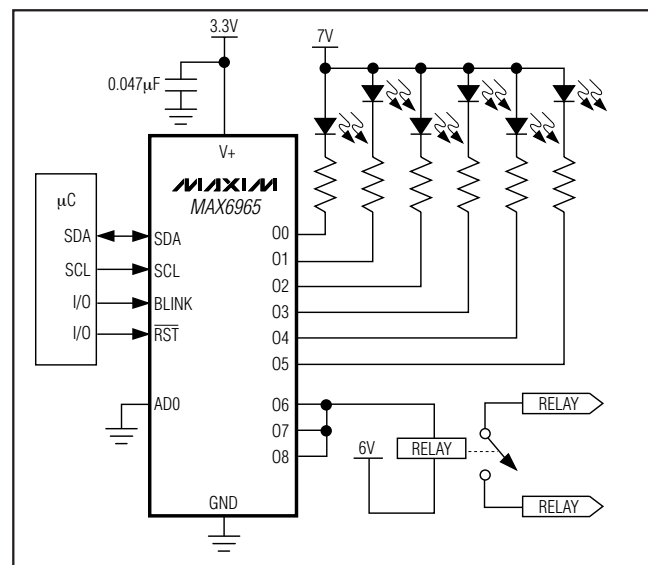

9-Output LED Driver with Intensity Control and Hot-Insertion Protection

ABSOLUTE MAXIMUM RATINGS

Voltage (with respect to GND)		Continuous Power Dissipation ($T_A = +70^\circ\text{C}$)	
V+	-0.3V to +4V	16-Pin QSOP (derate 8.3mW/ $^\circ\text{C}$ over $+70^\circ\text{C}$).....	666mW
SCL, SDA, AD0, BLINK, $\overline{\text{RST}}$	-0.3V to +6V	16-Pin QFN (derate 14.7mW/ $^\circ\text{C}$ over $+70^\circ\text{C}$)	1176mW
O0–O8	-0.3V to +8V	Operating Temperature Range (T_{MIN} to T_{MAX}) ...	-40°C to $+125^\circ\text{C}$
DC Current on O0 to O8	55mA	Junction Temperature	$+150^\circ\text{C}$
DC Current on SDA	10mA	Storage Temperature Range	-65°C to $+150^\circ\text{C}$
Maximum GND Current	190mA	Lead Temperature (soldering, 10s)	$+300^\circ\text{C}$

Stresses beyond those listed under "Absolute Maximum Ratings" may cause permanent damage to the device. These are stress ratings only, and functional operation of the device at these or any other conditions beyond those indicated in the operational sections of the specifications is not implied. Exposure to absolute maximum rating conditions for extended periods may affect device reliability.

ELECTRICAL CHARACTERISTICS

(Typical Operating Circuit, $V_+ = 2\text{V}$ to 3.6V , $T_A = T_{\text{MIN}}$ to T_{MAX} , unless otherwise noted. Typical values are at $V_+ = 3.3\text{V}$, $T_A = +25^\circ\text{C}$.) (Note 1)

PARAMETER	SYMBOL	CONDITIONS	MIN	TYP	MAX	UNITS
Operating Supply Voltage	V_+		2.0		3.6	V
Output Load External Supply Voltage	V_{EXT}		0		7	V
Standby Current (Interface Idle, PWM Disabled)	I_+	SCL and SDA at V_+ ; other digital inputs at V_+ or GND; PWM intensity control disabled	$T_A = +25^\circ\text{C}$	1.2	2.3	μA
			$T_A = -40^\circ\text{C}$ to $+85^\circ\text{C}$		2.6	
			$T_A = T_{\text{MIN}}$ to T_{MAX}		3.3	
Supply Current (Interface Idle, PWM Enabled)	I_+	SCL and SDA at V_+ ; other digital inputs at V_+ or GND; PWM intensity control enabled	$T_A = +25^\circ\text{C}$	7	12.1	μA
			$T_A = -40^\circ\text{C}$ to $+85^\circ\text{C}$		13.3	
			$T_A = T_{\text{MIN}}$ to T_{MAX}		14.4	
Supply Current (Interface Running, PWM Disabled)	I_+	$f_{\text{SCL}} = 400\text{kHz}$; other digital inputs at V_+ or GND; PWM intensity control disabled	$T_A = +25^\circ\text{C}$	40	76	μA
			$T_A = -40^\circ\text{C}$ to $+85^\circ\text{C}$		78	
			$T_A = T_{\text{MIN}}$ to T_{MAX}		80	
Supply Current (Interface Running, PWM Enabled)	I_+	$f_{\text{SCL}} = 400\text{kHz}$; other digital inputs at V_+ or GND; PWM intensity control enabled	$T_A = +25^\circ\text{C}$	51	110	μA
			$T_A = -40^\circ\text{C}$ to $+85^\circ\text{C}$		117	
			$T_A = T_{\text{MIN}}$ to T_{MAX}		122	
Input High Voltage SDA, SCL, AD0, BLINK, $\overline{\text{RST}}$	V_{IH}		0.7 x V_+			V
Input Low Voltage SDA, SCL, AD0, BLINK, $\overline{\text{RST}}$	V_{IL}				0.3 x V_+	V
Input Leakage Current SDA, SCL, AD0, BLINK, $\overline{\text{RST}}$	$I_{\text{IH}}, I_{\text{IL}}$	Input = GND or V_+	-0.2		+0.2	μA
Input Capacitance SDA, SCL, AD0, BLINK, $\overline{\text{RST}}$				8		pF

9-Output LED Driver with Intensity Control and Hot-Insertion Protection

MAX6965

ELECTRICAL CHARACTERISTICS (continued)

(Typical Operating Circuit, V+ = 2V to 3.6V, T_A = T_{MIN} to T_{MAX}, unless otherwise noted. Typical values are at V+ = 3.3V, T_A = +25°C.) (Note 1)

PARAMETER	SYMBOL	CONDITIONS		MIN	TYP	MAX	UNITS
Output Low Voltage O0–O8	VOL	V+ = 2V, I _{SINK} = 20mA	T _A = +25°C	0.15	0.25	V	
			T _A = -40°C to +85°C	0.29			
			T _A = T _{MIN} to T _{MAX}	0.31			
		V+ = 2.5V, I _{SINK} = 20mA	T _A = +25°C	0.13	0.22		
			T _A = -40°C to +85°C	0.25			
			T _A = T _{MIN} to T _{MAX}	0.27			
		V+ = 3.3V, I _{SINK} = 20mA	T _A = +25°C	0.12	0.22		
			T _A = -40°C to +85°C	0.23			
			T _A = T _{MIN} to T _{MAX}	0.25			
Output Low-Voltage SDA	VOLSDA	I _{SINK} = 6mA			0.4	V	
PWM Clock Frequency	f _{PWM}			32			kHz

TIMING CHARACTERISTICS

(Typical Operating Circuit, V+ = 2V to 3.6V, T_A = T_{MIN} to T_{MAX}, unless otherwise noted. Typical values are at V+ = 3.3V, T_A = +25°C.) (Note 1)

PARAMETER	SYMBOL	CONDITIONS	MIN	TYP	MAX	UNITS
Serial Clock Frequency	f _{SCL}				400	kHz
Bus Free Time Between a STOP and a START Condition	t _{BUF}		1.3			μs
Hold Time, Repeated START Condition	t _{HD, STA}		0.6			μs
Repeated START Condition Setup Time	t _{SU, STA}		0.6			μs
STOP Condition Setup Time	t _{SU, STO}		0.6			μs
Data Hold Time	t _{HD, DAT}	(Note 2)			0.9	μs
Data Setup Time	t _{SU, DAT}		180			ns
SCL Clock Low Period	t _{LOW}		1.3			μs
SCL Clock High Period	t _{HIGH}		0.7			μs
Rise Time of Both SDA and SCL Signals, Receiving	t _R	(Notes 3, 4)		20 + 0.1C _b	300	ns
Fall Time of Both SDA and SCL Signals, Receiving	t _F	(Notes 3, 4)		20 + 0.1C _b	300	ns
Fall Time of SDA Transmitting	t _{F, TX}	(Notes 3, 5)		20 + 0.1C _b	250	ns
Pulse Width of Spike Suppressed	t _{SP}	(Note 6)		50		ns
Capacitive Load for Each Bus Line	C _b	(Note 3)			400	pF

9-Output LED Driver with Intensity Control and Hot-Insertion Protection

TIMING CHARACTERISTICS (continued)

(Typical Operating Circuit, $V_+ = 2V$ to $3.6V$, $T_A = T_{MIN}$ to T_{MAX} , unless otherwise noted. Typical values are at $V_+ = 3.3V$, $T_A = +25^\circ C$.) (Note 1)

PARAMETER	SYMBOL	CONDITIONS	MIN	TYP	MAX	UNITS
RST Pulse Width	t_w		1			μs
Output Data Valid	t_{DV}	Figure 10			5	μs

Note 1: All parameters tested at $T_A = +25^\circ C$. Specifications over temperature are guaranteed by design.

Note 2: A master device must provide a hold time of at least 300ns for the SDA signal (referred to V_{IL} of the SCL signal) to bridge the undefined region of SCL's falling edge.

Note 3: Guaranteed by design.

Note 4: C_b = total capacitance of one bus line in pF. t_R and t_F measured between $0.3 \times V_{DD}$ and $0.7 \times V_{DD}$.

Note 5: $I_{SINK} \leq 6mA$. C_b = total capacitance of one bus line in pF. t_R and t_F measured between $0.3 \times V_{DD}$ and $0.7 \times V_{DD}$.

Note 6: Input filters on the SDA and SCL inputs suppress noise spikes less than 50ns.

Typical Operating Characteristics

($T_A = +25^\circ C$, unless otherwise noted.)

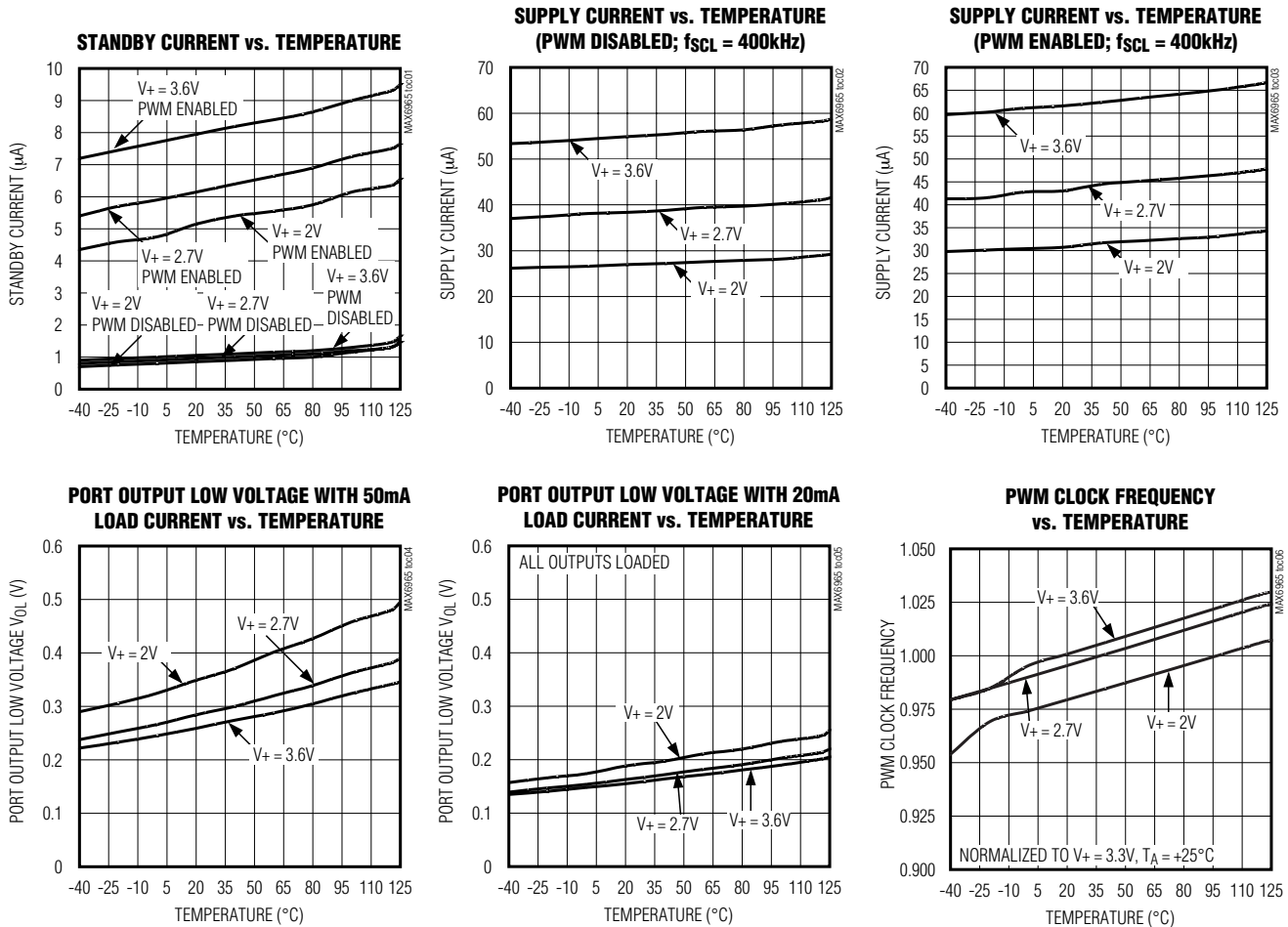

9-Output LED Driver with Intensity Control and Hot-Insertion Protection

MAX6965

Typical Operating Characteristics (continued)

($T_A = +25^\circ\text{C}$, unless otherwise noted.)

SCOPE SHOT OF TWO OUTPUT PORTS

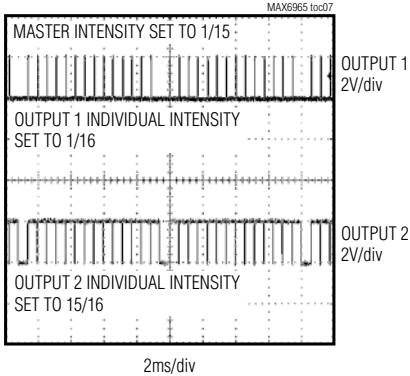

SCOPE SHOT OF TWO OUTPUT PORTS

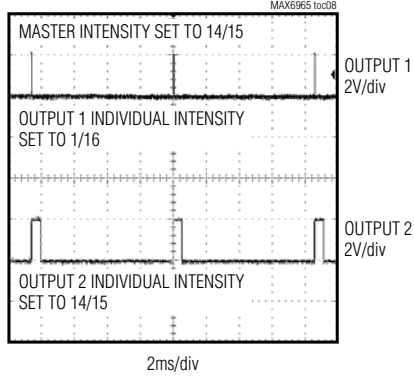

SINK CURRENT vs. V_{OL}

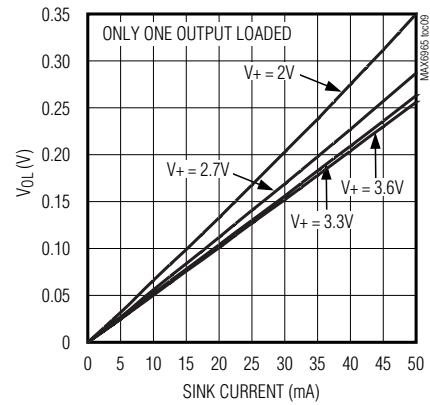

Pin Description

PIN		NAME	FUNCTION
QSOP	QFN		
1	15	BLINK	Input Port. Configurable as blink control or general-purpose input.
2	16	$\overline{\text{RST}}$	Reset Input. Active low clears the 2-wire interface and puts the device in same condition as power-up reset.
3	1	AD0	Address Input. Sets device slave address. Connect to either GND, V_+ , SCL, or SDA to give 4 logic combinations. See Table 1.
4–7, 9–13	2–5, 7–11	O0–O8	Output Ports. O0–O8 are open-drain outputs rated at 7V, 50mA.
8	6	GND	Ground. Do not sink more than 190mA into the GND pin.
14	12	SCL	I ² C-Compatible Serial Clock Input
15	13	SDA	I ² C-Compatible Serial Data I/O
16	14	V_+	Positive Supply Voltage. Bypass V_+ to GND with a 0.047 μF ceramic capacitor
—	PAD	Exposed Pad	Exposed pad on packaged underside. Connect to GND.

9-Output LED Driver with Intensity Control and Hot-Insertion Protection

Functional Overview

The MAX6965 is a general-purpose output (GPO) peripheral that provides nine output ports, O0–O8, controlled through an I²C-compatible serial interface. All outputs sink loads up to 50mA connected to external supplies up to 7V, independent of the MAX6965's supply voltage. The MAX6965 is rated for a ground current of 190mA, allowing all nine outputs to sink 20mA at the same time. Figure 1 shows the output structure of the MAX6965. The outputs default to logic high (high impedance unless external pullup resistors are used) on power-up.

Output Control and LED Blinking

The blink phase 0 register sets the output logic levels of the 8 outputs O0–O7 (Table 6). This register controls the port outputs if the blink function is disabled. A duplicate register, the Blink Phase 1 register, is also used if the blink function is enabled (Table 7). In blink mode, the outputs can be flipped between using the blink phase 0 register, and the blink phase 1 register using hardware control (the BLINK input) and/or software control (the blink flip flag in the configuration register) (Table 4).

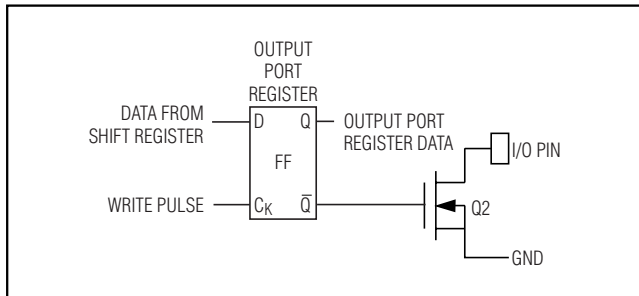

Figure 1. Simplified Schematic of I/O Ports

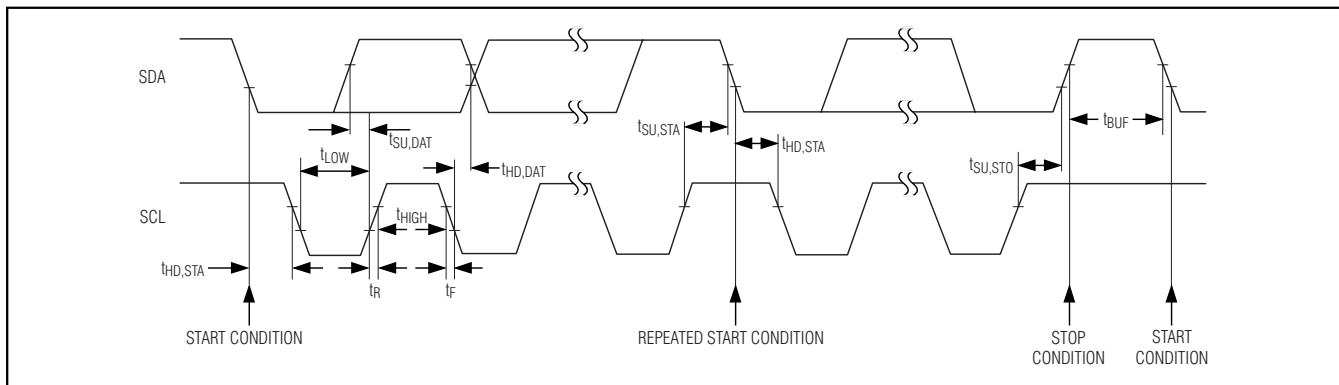

Figure 2. 2-Wire Serial Interface Timing Details

The 9th output, O8, is controlled through 2 bits in the Configuration register, which provide the same static or blink control as the other eight outputs (Table 4).

The logic level of the BLINK input may be read back through the blink status bit in the configuration register (Table 4). The BLINK input, therefore, may be used as a general-purpose logic input (GPI port) if the blink function is not required.

PWM Intensity Control

The MAX6965 includes an internal oscillator, nominally 32kHz, to generate PWM timing for LED intensity control. PWM intensity control can be enabled on an output-by-output basis, allowing the MAX6965 to provide any mix of PWM LED drives and glitch-free logic outputs (Table 8). PWM can be disabled entirely, in which case all outputs are static and the MAX6965 operating current is lowest because the internal oscillator is turned off.

PWM intensity control uses a 4-bit master control and 4 bits of individual control per output (Tables 11 and 12). The 4-bit master control provides 16 levels of overall intensity control, which applies to all PWM-enabled outputs. The master control sets the maximum pulse width from 1/15 to 15/15 of the PWM time period. The individual settings comprise a 4-bit number, further reducing the duty cycle to be from 1/16 to 15/16 of the time window set by the master control.

For applications requiring the same PWM setting for all output ports, a single global PWM control can be used instead of all the individual controls to simplify the control software and provide 240 steps of intensity control (Tables 8 and 11).

9-Output LED Driver with Intensity Control and Hot-Insertion Protection

User RAM

The MAX6965 includes a register byte, which is available as general-user RAM (Table 2). This byte is reset to the value 0xFF on power-up and when the $\overline{\text{RST}}$ input is taken low (Table 3).

Standby Mode

When the serial interface is idle and the PWM intensity control is unused, the MAX6965 automatically enters standby mode. If the PWM intensity control is used, the operating current is slightly higher because the internal PWM oscillator is running. When the serial interface is active, the operating current also increases because the MAX6965, like all I²C slaves, has to monitor every transmission.

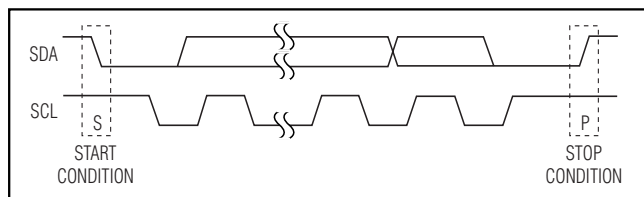

Figure 3. Start and Stop Conditions

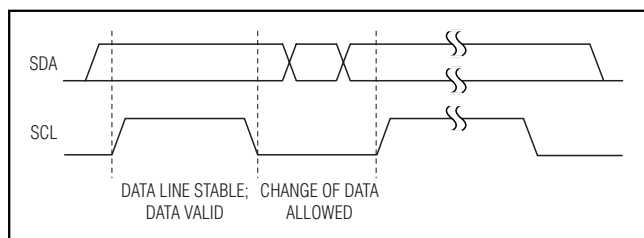

Figure 4. Bit Transfer

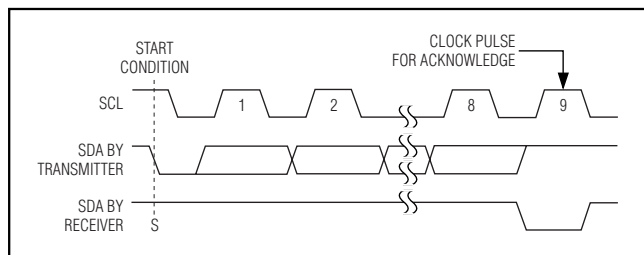

Figure 5. Acknowledge

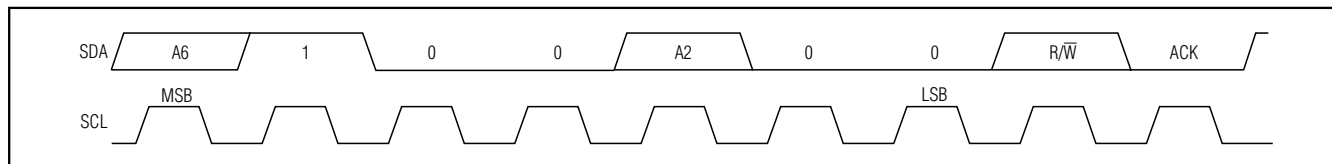

Figure 6. Slave Address

Serial Interface

Serial Addressing

The MAX6965 operates as a slave that sends and receives data through an I²C-compatible 2-wire interface. The interface uses a serial data line (SDA) and a serial clock line (SCL) to achieve bidirectional communication between master(s) and slave(s). A master (typically a microcontroller) initiates all data transfers to and from the MAX6965 and generates the SCL clock that synchronizes the data transfer (Figure 2).

The MAX6965 SDA line operates as both an input and an open-drain output. A pullup resistor, typically 4.7k Ω , is required on SDA. The MAX6965 SCL line operates only as an input. A pullup resistor, typically 4.7k Ω , is required on SCL if there are multiple masters on the 2-wire interface, or if the master in a single-master system has an open-drain SCL output.

Each transmission consists of a START condition (Figure 3) sent by a master, followed by the MAX6965 7-bit slave address plus R/W bit, a register address byte, one or more data bytes, and finally a STOP condition (Figure 3).

Start and Stop Conditions

Both SCL and SDA remain high when the interface is not busy. A master signals the beginning of a transmission with a START (S) condition by transitioning SDA from high to low while SCL is high. When the master has finished communicating with the slave, it issues a STOP (P) condition by transitioning SDA from low to high while SCL is high. The bus is then free for another transmission (Figure 3).

Bit Transfer

One data bit is transferred during each clock pulse. The data on SDA must remain stable while SCL is high (Figure 4).

Acknowledge

The acknowledge bit is a clocked 9th bit that the recipient uses to handshake receipt of each byte of data (Figure 5). Thus, each byte transferred effectively requires 9 bits. The master generates the 9th clock pulse, and the recipient pulls down SDA during the acknowledge clock pulse so the SDA line is stable low

9-Output LED Driver with Intensity Control and Hot-Insertion Protection

Table 1. MAX6965 I²C Slave Address Map

PIN ADO	DEVICE ADDRESS						
	A6	A5	A4	A3	A2	A1	A0
SCL	1	1	0	0	0	0	0
SDA	1	1	0	0	1	0	0
GND	0	1	0	0	0	0	0
V+	0	1	0	0	1	0	0

Table 2. Register Address Map

REGISTER	ADDRESS CODE (hex)	AUTOINCREMENT ADDRESS
Blink phase 0 outputs	0x01	0x01 (no change)
User RAM	0x03	0x03 (no change)
Blink phase 1 outputs	0x09	0x09 (no change)
Master, O8 intensity	0x0E	0x0E (no change)
Configuration	0x0F	0x0F (no change)
Outputs intensity O1, O0	0x10	0x11
Outputs intensity O3, O2	0x11	0x12
Outputs intensity O5, O4	0x12	0x13
Outputs intensity O7, O6	0x13	0x10

during the high period of the clock pulse. When the master is transmitting to the MAX6965, the device generates the acknowledge bit because the MAX6965 is the recipient. When the MAX6965 is transmitting to the master, the master generates the acknowledge bit because the master is the recipient.

Slave Address

The MAX6965 has a 7-bit long slave address (Figure 6). The eighth bit following the 7-bit slave address is the R/W bit. The R/W bit is low for a write command, high for a read command.

The second (A5), third (A4), fourth (A3), sixth (A1), and last (A0) bits of the MAX6965 slave address are always 1, 0, 0, 0, and 0. Slave address bits A6 and A2 are selected by the address input ADO. ADO can be connected to GND, V+, SDA, or SCL. The MAX6965 has four possible slave addresses (Table 1), and therefore a maximum of four MAX6965 devices can be controlled independently from the same interface.

Message Format for Writing the MAX6965

A write to the MAX6965 comprises the transmission of the MAX6965's slave address with the R/W bit set to zero, followed by at least 1 byte of information. The first byte of information is the command byte. The command byte determines which register of the MAX6965 is to be written to by the next byte, if received (Table 2). If a STOP condition is detected after the command byte is received, then the MAX6965 takes no further action beyond storing the command byte.

Any bytes received after the command byte are data bytes. The first data byte goes into the internal register of the MAX6965 selected by the command byte (Figure 8). If multiple data bytes are transmitted before a STOP condition is detected, these bytes are generally stored in subsequent MAX6965 internal registers because the command byte address autoincrements (Table 2). A diagram of a write to the output ports registers (blink phase 0 register or blink phase 1 register) is given in Figure 10.

9-Output LED Driver with Intensity Control and Hot-Insertion Protection

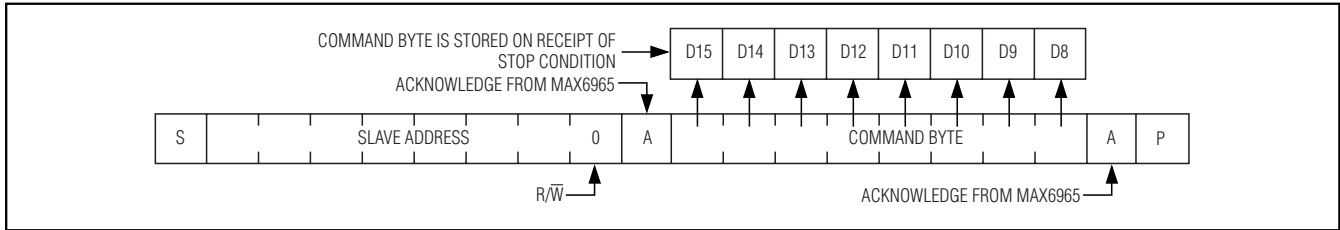

Figure 7. Command Byte Received

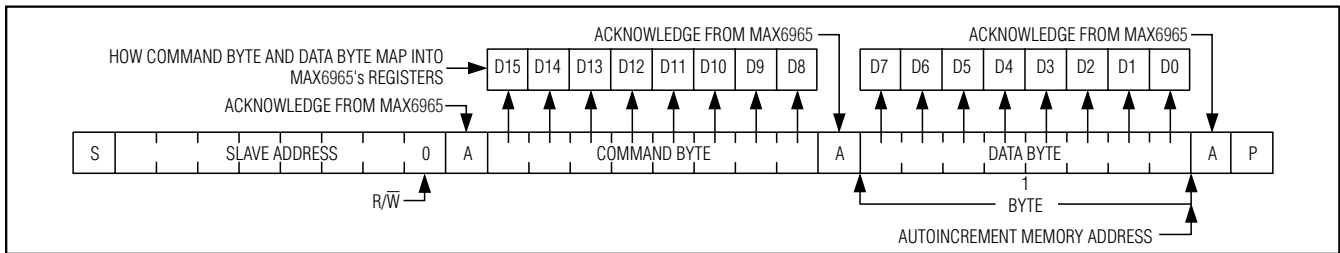

Figure 8. Command and Single Data Byte Received

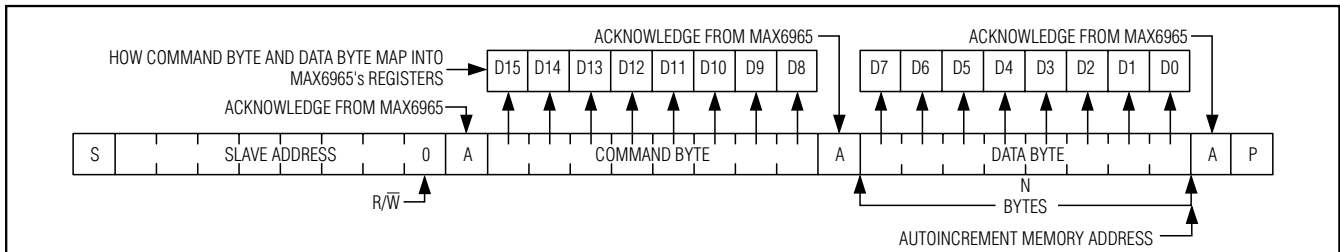

Figure 9. n Data Bytes Received

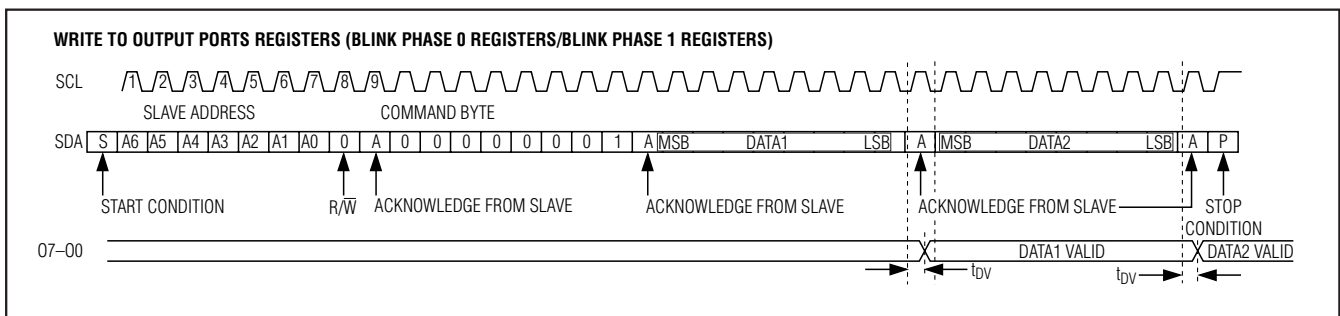

Figure 10. Write Timing Diagram

Message Format for Reading

The MAX6965 is read using the MAX6965's internally stored command byte as an address pointer the same way the stored command byte is used as an address pointer for a write. The pointer autoincrements after each data byte is read using the same rules as for a write (Table 2). Thus, a read is initiated by first configuring the MAX6965's command byte by performing a

write (Figure 7). The master can now read n consecutive bytes from the MAX6965 with the first data byte being read from the register addressed by the initialized command byte. When performing read-after-write verification, remember to reset the command byte's address because the stored command byte address has been autoincremented after the write (Table 2).

9-Output LED Driver with Intensity Control and Hot-Insertion Protection

Operation with Multiple Masters

If the MAX6965 is operated on a 2-wire interface with multiple masters, a master reading the MAX6965 should use a repeated start between the write, which sets the MAX6965's address pointer, and the read(s) that takes the data from the location(s) (Table 2). This is because it is possible for master 2 to take over the bus after master 1 has set up the MAX6965's address pointer but before master 1 has read the data. If master 2 subsequently changes the MAX6965's address pointer, then master 1's delayed read can be from an unexpected location.

Command Address Autoincrementing

The command address stored in the MAX6965 circulates around grouped register functions after each data byte is written or read (Table 2).

Device Reset

The reset input \overline{RST} is an active-low input. When taken low, \overline{RST} clears any transaction to or from the MAX6965 on the serial interface and configures the internal registers to the same state as a power-up reset (Table 3). The MAX6965 then waits for a START condition on the serial interface.

Detailed Description

Initial Power-Up

On power-up, and whenever the \overline{RST} input is pulled low, all control registers are reset and the MAX6965 enters standby mode (Table 3). Power-up status makes all outputs logic high (high impedance if external pullup resistors are not fitted) and disables both the PWM oscillator and blink functionality. The \overline{RST} input can be used as a hardware shutdown input, which effectively turns off any LED (or other) loads and puts the device into its lowest power condition.

Configuration Register

The configuration register is used to configure the PWM intensity mode and blink behavior, operate the O8 output, and read back the BLINK input logic level (Table 4).

Blink Mode

In blink mode, the outputs can be flipped between using either the blink phase 0 register or the blink phase 1 register. Flip control is both hardware (the BLINK input) and software control (the blink flip flag B in the configuration register) (Table 4).

The blink function can be used for LED effects by programming different display patterns in the two sets of output port registers, and using the software or hardware controls to flip between the patterns.

If the blink phase 1 register is written with 0xFF, then the BLINK input can be used as a hardware disable to, for example, instantly turn off an LED pattern programmed into the blink phase 0 register. This technique can be further extended by driving the BLINK input with a PWM signal to modulate the LED current to provide fading effects.

The blink mode is enabled by setting the blink enable flag E in the configuration register (Table 4). When blink mode is enabled, the state of the blink flip flag and BLINK input are EXOR'ed to set the phase, and the outputs are set by either the blink phase 0 registers or the blink phase 1 registers (Figure 11, Table 5).

The blink mode is disabled by clearing the blink enable flag E in the configuration register (Table 4). When blink mode is disabled, the state of the blink flip flag is ignored, and the blink phase 0 registers alone control the outputs.

The logic status of BLINK is made available as the read-only blink status flag blink in the configuration register (Table 4). This flag allows BLINK to be used as an extra general-purpose input (GPI) in applications not using the blink function. When BLINK is going to be used as a GPI, blink mode should be disabled by clearing the blink enable flag E in the configuration register (Table 4).

Blink Phase Register

When the blink function is disabled, the blink phase 0 register sets the logic levels of the eight outputs (O0 through O7) (Table 6). A duplicate register called the blink phase 1 register is also used if the blink function is enabled (Table 7). A logic high sets the appropriate output high impedance, while a logic low makes the port go low.

Reading a blink phase register reads the value stored in the register, not the actual port condition. The port output itself may or may not be at a valid logic level, depending on the external load connected.

The 9th output, O8, is controlled through 2 bits in the configuration register, which provide the same static or blink control as the other eight output ports.

9-Output LED Driver with Intensity Control and Hot-Insertion Protection

MAX6965

Table 3. Power-Up Configuration

REGISTER FUNCTION	POWER-UP CONDITION	ADDRESS CODE (HEX)	REGISTER DATA							
			D7	D6	D5	D4	D3	D2	D1	D0
Blink phase 0 outputs	High-impedance outputs	0x01	1	1	1	1	1	1	1	1
User RAM	0xFF	0x03	1	1	1	1	1	1	1	1
Blink phase 1 outputs	High-impedance outputs	0x09	1	1	1	1	1	1	1	1
Master, O8 intensity	PWM oscillator is disabled; O8 is static logic output	0x0E	0	0	0	0	1	1	1	1
Configuration	O8 is high-impedance output; blink is disabled; global intensity is enabled	0x0F	0	0	1	1	0	1	0	0
Outputs intensity O1, O0	O1, O0 are static logic outputs	0x10	1	1	1	1	1	1	1	1
Outputs Intensity O3, O2	O3, O2 are static logic outputs	0x11	1	1	1	1	1	1	1	1
Outputs intensity O5, O4	O5, O4 are static logic outputs	0x12	1	1	1	1	1	1	1	1
Outputs intensity O7, O6	O7, O6 are static logic outputs	0x13	1	1	1	1	1	1	1	1

Table 4. Configuration Register

REGISTER	R/W	ADDRESS CODE (HEX)	REGISTER DATA							
			D7	D6	D5	D4	D3	D2	D1	D0
CONFIGURATION			I	BLINK STATUS	OUTPUT O8		I	GLOBAL INTENSITY	BLINK FLIP	BLINK ENABLE
Write device configuration	0	0x0F	X	BLINK	O1	O0	X	G	B	E
Read-back device configuration	1		0							
Disable blink	—		X	X	X	X	X	X	X	0
Enable blink	—		X	X	X	X	X	X	X	1
Flip blink register (see text)	—		X	X	X	X	X	X	0	1
	—		X	X	X	X	X	X	1	1
Disable global intensity control—intensity is set by registers 0x10–0x13 for ports O0 through O7 when configured as outputs, and by D3–D0 of register 0x0E for output O8	—		X	X	X	X	X	0	X	X
Enable global intensity control—intensity for all ports configured as outputs is set by D3–D0 of register 0x0E	—		X	X	X	X	X	1	X	X

X = Don't care.

9-Output LED Driver with Intensity Control and Hot-Insertion Protection

Table 4. Configuration Register (continued)

REGISTER	R/W	ADDRESS CODE (HEX)	REGISTER DATA							
			D7	D6	D5	D4	D3	D2	D1	D0
CONFIGURATION		0x0F	I	BLINK STATUS	OUTPUT O8		I	GLOBAL INTENSITY	BLINK FLIP	BLINK ENABLE
Write device configuration	0		X	BLINK	O1	O0	X	G	B	E
Read-back device configuration	1		0				0			
O8 output is low (blink is disabled)	—		X	X	X	0	0	X	X	0
O8 output is high impedance (blink is disabled)	—		X	X	X	1	0	X	X	0
O8 output is low during blink phase 0	—		X	X	X	0	0	X	X	1
O8 output is high impedance during blink phase 0	—		X	X	X	1	0	X	X	1
O8 output is low during blink phase 1	—		X	X	0	X	0	X	X	1
O8 output is high impedance during blink phase 1	—		X	X	1	X	0	X	X	1
Read-back BLINK input pin status; input is low	1		X	0	X	X	X	X	X	X
Read-back BLINK input pin status; input is high	1		X	1	X	X	X	X	X	X

X = Don't care.

Table 5. Blink Controls

BLINK ENABLE FLAG E	BLINK FLIP FLAG B	BLINK INPUT PIN	BLINK FLIP FLAG EXOR BLINK INPUT PIN	BLINK FUNCTION	OUTPUT REGISTERS USED
0	X	X	X	Disabled	Blink phase 0
1	0	0	0	Enabled	Blink phase 0
	0	1	1		Blink phase 1
	1	0	1		Blink phase 1
	1	1	0		Blink phase 0

X = Don't care.

9-Output LED Driver with Intensity Control and Hot-Insertion Protection

MAX6965

Table 6. Blink Phase 0 Register

REGISTER	R/W	ADDRESS CODE (hex)	REGISTER DATA							
			D7	D6	D5	D4	D3	D2	D1	D0
Write outputs phase 0	0	0x01	OP7	OP6	OP5	OP4	OP3	OP2	OP1	OP0
Read-back outputs phase 0	1									

Table 7. Blink Phase 1 Register

REGISTER	R/W	ADDRESS CODE (hex)	REGISTER DATA							
			D7	D6	D5	D4	D3	D2	D1	D0
Write outputs phase 1	0	0x09	OP7	OP6	OP5	OP4	OP3	OP2	OP1	OP0
Read-back outputs phase 1	1									

Table 8. PWM Application Scenarios

APPLICATION	RECOMMENDED CONFIGURATION
All outputs static without PWM	Set the master, O8 intensity register 0x0E to any value from 0x00 to 0x0F. The global intensity G bit in the configuration register is don't care. The output intensity registers 0x10 through 0x13 are don't care.
A mix of static and PWM outputs, with PWM outputs using different PWM settings	Set the master, O8 intensity register 0x0E to any value from 0x10 to 0xFF. Clear global intensity G bit to 0 in the configuration register to disable global intensity control. For the static outputs, set the output intensity value to 0xF. For the PWM outputs, set the output intensity value in the range 0x0 to 0xE.
A mix of static and PWM outputs, with PWM outputs all using the same PWM setting	As above. Global intensity control cannot be used with a mix of static and PWM outputs, so write the individual intensity registers with the same PWM value.
All outputs PWM using the same PWM setting	Set the master, O8 intensity register 0x0E to any value from 0x10 to 0xFF. Set global intensity G bit to 1 in the configuration register to enable global intensity control. The master, O8 intensity register 0x0E is the only intensity register used. The output intensity registers 0x10 through 0x13 are don't care.

9-Output LED Driver with Intensity Control and Hot-Insertion Protection

PWM Intensity Control

The MAX6965 includes an internal oscillator, nominally 32kHz, to generate PWM timing for LED intensity control or other applications such as PWM trim DACs. PWM can be disabled entirely for all the outputs. In this case, all outputs are static and the MAX6965 operating current is lowest because the internal PWM oscillator is turned off.

The MAX6965 can be configured to provide any combination of PWM outputs and glitch-free logic outputs. Each PWM output has an individual 4-bit intensity control (Table 12). When all outputs are to be used with the same PWM setting, the outputs can be controlled together instead of using the global intensity control (Table 11). Table 8 shows how to set up the MAX6965 to suit a particular application.

PWM Timing

The PWM control uses a 240-step PWM period, divided into 15 master intensity timeslots. Each master intensity timeslot is divided further into 16 PWM cycles (Figure 12).

The master intensity operates as a gate, allowing the individual output settings to be enabled from 1 to 15 timeslots per PWM period (Figures 13, 14, and 15) (Table 11).

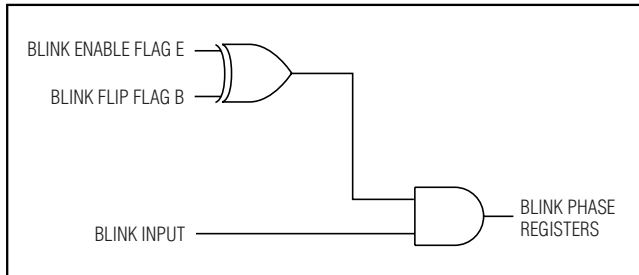

Figure 11. BLINK Logic

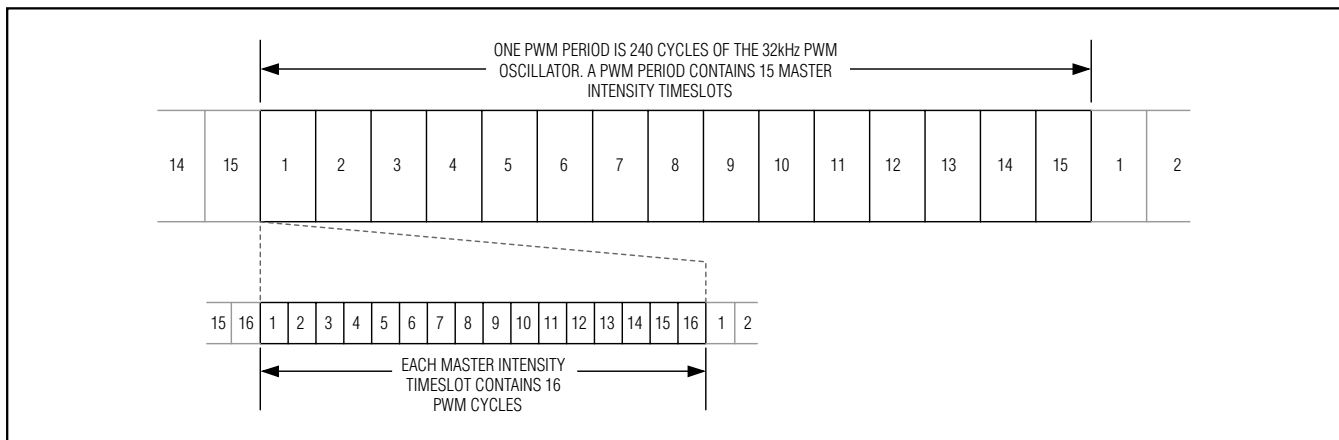

Figure 12. PWM Timing

Each output's individual 4-bit intensity control only operates during the number of timeslots gated by the master intensity. The individual controls provide 16 intensity settings from 1/16 through 16/16 (Table 12).

Figures 16, 17, and 18 show examples of individual intensity control settings. The highest value an individual or global setting can be set to is 16/16. This setting forces the output to ignore the master control, and follow the logic level set by the appropriate blink phase register bit. The output becomes a glitch-free static output with no PWM.

Using PWM Intensity Controls with Blink Disabled

When blink is disabled (Table 5), the blink phase 0 register specifies each output's logic level during the PWM on-time (Table 6). The effect of setting an output's blink phase 0 register bit to 0 or 1 is shown in Table 9. With its output bit set to zero, an LED can be controlled with 16 intensity settings from 1/16th duty through fully on, but cannot be turned fully off using the PWM intensity control. With its output bit set to 1, an LED can be controlled with 16 intensity settings from fully off through 15/16th duty.

Using PWM Intensity Controls with Blink Enabled

When blink is enabled (Table 5), the blink phase 0 register and blink phase 1 register specify each output's logic level during the PWM on-time during the respective blink phases (Tables 6 and 7). The effect of setting an output's blink phase register bit to 0 or 1 is shown in Table 10. LEDs can be flipped between either directly on and off, or between a variety of high/low PWM intensities.

9-Output LED Driver with Intensity Control and Hot-Insertion Protection

Global/O8 Intensity Control

The 4 bits used for output O8's PWM individual intensity setting also double as the global intensity control (Table 11). Global intensity simplifies the PWM settings when the application requires them all to be the same, such as for backlight applications, by replacing the nine individual settings with one setting. Global intensity is enabled with the global intensity flag G in the configuration register (Table 4). When global PWM control is used, the 4 bits of master intensity and 4 bits of O8 intensity effectively combine to provide an 8-bit, 240-step intensity control applying to all outputs.

It is not possible to apply global PWM control to a subset of the ports, and use the others as logic outputs. To mix static logic outputs and PWM outputs, individual PWM control must be selected (Table 8).

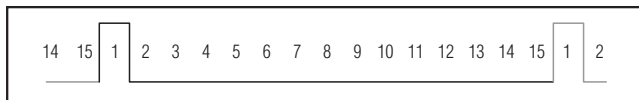

Figure 13. Master Set to 1/15

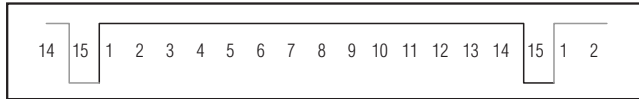

Figure 14. Master Set to 14/15

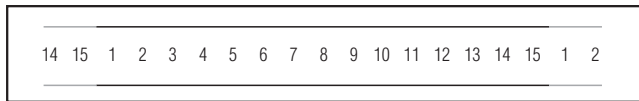

Figure 15. Master Set to 15/15

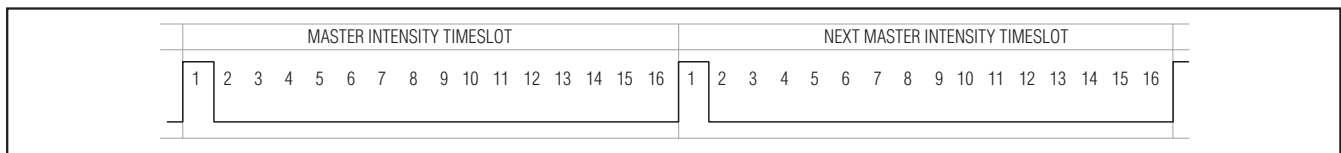

Figure 16. Individual (or Global) Set to 1/16

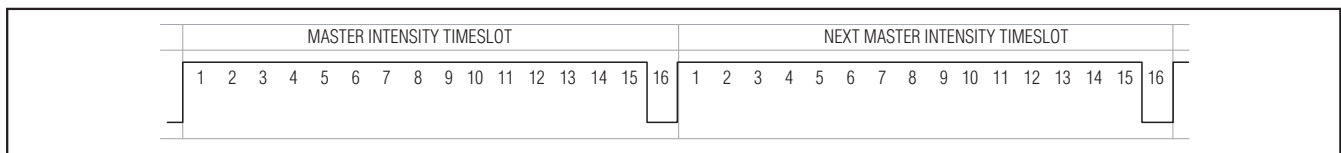

Figure 17. Individual (or Global) Set to 15/16

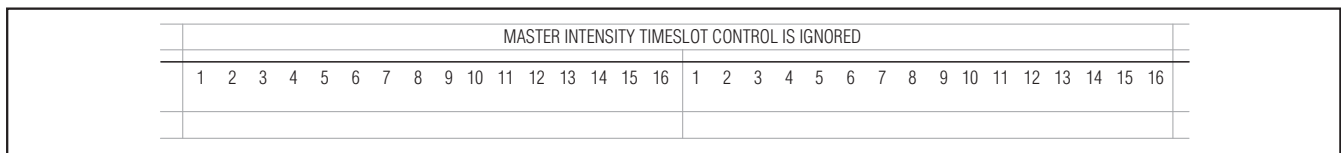

Figure 18. Individual (or Global) Set to 16/16

Applications Information

Hot Insertion

The $\overline{\text{RST}}$ input, BLINK input, and serial interface SDA, SCL, ADO remain high impedance with up to 6V asserted on them when the MAX6965 is powered down ($V+ = 0V$). Output ports O0–O8 remain high impedance with up to 8V asserted on them. The MAX6965 can therefore be used in hot-swap applications.

Output Level Translation

The open-drain output architecture allows the ports to level translate the outputs to higher or lower voltages than the MAX6965 supply. An external pullup resistor can be used on any output to convert the high-impedance logic-high condition to a positive voltage level. The resistor can be connected to any voltage up to 7V. For interfacing CMOS inputs, a pullup resistor value of 220k Ω is a good starting point. Use a lower resistance to improve noise immunity, in applications where power consumption is less critical, or where a faster rise time is needed for a given capacitive load.

Driving LED Loads

When driving LEDs, a resistor in series with the LED must be used to limit the LED current to no more than 50mA. Choose the resistor value according to the following formula:

$$R_{LED} = (V_{SUPPLY} - V_{LED} - V_{OL}) / I_{LED}$$

where:

R_{LED} is the resistance of the resistor in series with the LED (Ω).

9-Output LED Driver with Intensity Control and Hot-Insertion Protection

V_{SUPPLY} is the supply voltage used to drive the LED (V).
 V_{LED} is the forward voltage of the LED (V).
 V_{OL} is the output low voltage of the MAX6965 when sinking I_{LED} (V).
 I_{LED} is the desired operating current of the LED (A).

For example, to operate a 2.2V red LED at 14mA from a 5V supply, R_{LED} = (5 - 2.2 - 0.25) / 0.014 = 182Ω.

Driving Load Currents Higher than 50mA

The MAX6965 can be used to drive loads drawing more than 50mA, like relays and high-current white LEDs, by paralleling outputs. Use at least one output per 50mA of load current; for example, a 6V 330mW relay draws 55mA and needs two paralleled outputs to drive it. Ensure that the paralleled outputs chosen are controlled by the same blink phase register, i.e., select outputs from the O0 through O7 range. This way, the paralleled outputs are turned on and off together. Do not use output O8 as part of a load-sharing design. O8 cannot be switched at the same time as any of the other outputs because it is controlled by a different register.

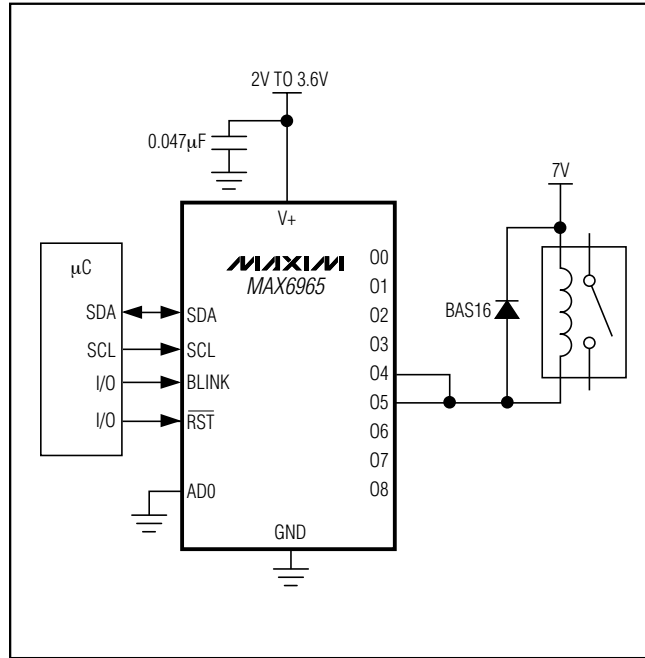

Figure 19. Diode-Protected Switching Inductive Load

Table 9. PWM Intensity Settings (Blink Disabled)

OUTPUT (OR GLOBAL) INTENSITY SETTING	PWM DUTY CYCLE OUTPUT BLINK PHASE 0 REGISTER BIT = 0		LED BEHAVIOR WHEN OUTPUT BLINK PHASE 0 REGISTER BIT = 0 (LED IS ON WHEN OUTPUT IS LOW)	PWM DUTY CYCLE OUTPUT BLINK PHASE 0 REGISTER BIT = 1		LED BEHAVIOR WHEN OUTPUT BLINK PHASE 0 REGISTER BIT = 1 (LED IS ON WHEN OUTPUT IS LOW)	
	LOW TIME	HIGH TIME		LOW TIME	HIGH TIME		
0x0	1/16	15/16	← Increasing PWM intensity	15/16	1/16	Highest PWM intensity	
0x1	2/16	14/16		14/16	2/16	Increasing PWM intensity →	
0x2	3/16	13/16		13/16	3/16		
0x3	4/16	12/16		12/16	4/16		
0x4	5/16	11/16		11/16	5/16		
0x5	6/16	10/16		10/16	6/16		
0x6	7/16	9/16		9/16	7/16		
0x7	8/16	8/16		8/16	8/16		
0x8	9/16	7/16		7/16	9/16		
0x9	10/16	6/16		6/16	10/16		
0xA	11/16	5/16		5/16	11/16		
0xB	12/16	4/16		4/16	12/16		
0xC	13/16	3/16		3/16	13/16		
0xD	14/16	2/16		2/16	14/16		
0xE	15/16	1/16		Highest PWM intensity	1/16		15/16
0xF	Static low	Static low	Full intensity, no PWM (LED on continuously)	Static high impedance	Static high impedance		LED off continuously

9-Output LED Driver with Intensity Control and Hot-Insertion Protection

MAX6965

Table 10. PWM Intensity Settings (Blink Enabled)

OUTPUT (OR GLOBAL) INTENSITY SETTING	PWM DUTY CYCLE OUTPUT BLINK PHASE X REGISTER BIT = 0		PWM DUTY CYCLE OUTPUT BLINK PHASE X REGISTER BIT = 1		EXAMPLES OF LED BLINK BEHAVIOR (LED IS ON WHEN OUTPUT IS LOW)	
	LOW TIME	HIGH TIME	LOW TIME	HIGH TIME	BLINK PHASE 0 REGISTER BIT = 0 BLINK PHASE 1 REGISTER BIT = 1	BLINK PHASE 0 REGISTER BIT = 1 BLINK PHASE 1 REGISTER BIT = 0
0x0	1/16	15/16	15/16	1/16	Phase 0: LED on at low intensity Phase 1: LED on at high intensity	Phase 0: LED on at high intensity Phase 1: LED on at low intensity
0x1	2/16	14/16	14/16	2/16		
0x2	3/16	13/16	13/16	3/16		
0x3	4/16	12/16	12/16	4/16		
0x4	5/16	11/16	11/16	5/16		
0x5	6/16	10/16	10/16	6/16		
0x6	7/16	9/16	9/16	7/16		
0x7	8/16	8/16	8/16	8/16	Output is half intensity during both blink phases	
0x8	9/16	7/16	7/16	9/16	Phase 0: LED on at high intensity Phase 1: LED on at low intensity	Phase 0: LED on at low intensity Phase 1: LED on at high intensity
0x9	10/16	6/16	6/16	10/16		
0xA	11/16	5/16	5/16	11/16		
0xB	12/16	4/16	4/16	12/16		
0xC	13/16	3/16	3/16	13/16		
0xD	14/16	2/16	2/16	14/16		
0xE	15/16	1/16	1/16	15/16		
0xF	Static low	Static low	Static high impedance	Static high impedance	Phase 0: LED on continuously Phase 1: LED off continuously	Phase 0: LED off continuously Phase 1: LED on continuously

The MAX6965 must be protected from the negative voltage transient generated when switching off inductive loads, such as relays, by connecting a reverse-biased diode across the inductive load (Figure 19). The peak current through the diode is the inductive load's operating current.

Power-Supply Considerations

The MAX6965 operates with a power-supply voltage of 2V to 3.6V. Bypass the power supply to GND with at least 0.047µF as close to the device as possible.

For the QFN version, connect to the underside exposed pad to GND.

9-Output LED Driver with Intensity Control and Hot-Insertion Protection

Table 11. Master, O8 Intensity Register

REGISTER	R/W	ADDRESS CODE (HEX)	REGISTER DATA							
			D7	D6	D5	D4	D3	D2	D1	D0
MASTER AND GLOBAL INTENSITY			MSB				LSB			
			MASTER INTENSITY				O8 INTENSITY			
Write master and global intensity	0	0X0E	M3	M2	M1	M0	G3	G2	G1	G0
Read-back master and global intensity	1		0	0	0	0	—	—	—	—
Master intensity duty cycle is 0/15 (off); internal oscillator is disabled; all outputs will be static with no PWM	—		0	0	0	1	—	—	—	—
Master intensity duty cycle is 1/15	—		0	0	1	0	—	—	—	—
Master intensity duty cycle is 2/15	—		0	0	1	1	—	—	—	—
Master intensity duty cycle is 3/15	—		—	—	—	—	—	—	—	—
—	—		1	1	0	1	—	—	—	—
Master intensity duty cycle is 13/15	—		1	1	1	0	—	—	—	—
Master intensity duty cycle is 14/15	—		1	1	1	1	—	—	—	—
Master intensity duty cycle is 15/15 (full)	—		—	—	—	—	0	0	0	0
—	—		—	—	—	—	0	0	0	1
O8 intensity duty cycle is 1/16	—		—	—	—	—	0	0	1	0
O8 intensity duty cycle is 2/16	—		—	—	—	—	—	—	—	—
O8 intensity duty cycle is 3/16	—		—	—	—	—	1	1	0	1
—	—		—	—	—	—	1	1	1	0
O8 intensity duty cycle is 14/16	—		—	—	—	—	1	1	1	1
O8 intensity duty cycle is 15/16	—	—	—	—	—	1	1	1	1	
O8 intensity duty cycle is 16/16 (static output, no PWM)	—	—	—	—	—	1	1	1	1	

9-Output LED Driver with Intensity Control and Hot-Insertion Protection

MAX6965

Table 12. Output Intensity Registers

REGISTER	R/W	ADDRESS CODE (HEX)	REGISTER DATA							
			D7	D6	D5	D4	D3	D2	D1	D0
OUTPUTS O1, O0 INTENSITY		0x10	MSB				LSB			
			OUTPUT O1 INTENSITY				OUTPUT O0 INTENSITY			
Write output O1, O0 intensity	0		O1I3	O1I2	O1I1	O1I0	O0I3	O0I2	O0I1	O0I0
Read-back output O1, O0 intensity	1		0	0	0	0	—	—	—	—
Output O1 intensity duty cycle is 1/16	—		0	0	0	1	—	—	—	—
Output O1 intensity duty cycle is 2/16	—		0	0	1	0	—	—	—	—
Output O1 intensity duty cycle is 3/16	—		—	—	—	—	—	—	—	—
—	—		—	—	—	—	—	—	—	—
Output O1 intensity duty cycle is 14/16	—		1	1	0	1	—	—	—	—
Output O1 intensity duty cycle is 15/16	—		1	1	1	0	—	—	—	—
Output O1 intensity duty cycle is 16/16 (static logic level, no PWM)	—		1	1	1	1	—	—	—	—
—	—		—	—	—	—	—	—	—	—
Output O0 intensity duty cycle is 1/16	—		—	—	—	—	0	0	0	0
Output O0 intensity duty cycle is 2/16	—		—	—	—	—	0	0	0	1
Output O0 intensity duty cycle is 3/16	—		—	—	—	—	0	0	1	0
—	—		—	—	—	—	—	—	—	—
Output O0 intensity duty cycle is 14/16	—	—	—	—	—	1	1	0	1	
Output O0 intensity duty cycle is 15/16	—	—	—	—	—	1	1	1	0	
Output O0 intensity duty cycle is 16/16 (static logic level, no PWM)	—	—	—	—	—	1	1	1	1	
OUTPUTS O3, O2 INTENSITY		0x11	MSB				LSB			
			OUTPUT O3 INTENSITY				OUTPUT O2 INTENSITY			
Write output O3, O2 intensity	0		O3I3	O3I2	O3I1	O3I0	O2I3	O2I2	O2I1	O2I0
Read-back output O3, O2 intensity	1									
OUTPUTS O5, O4 INTENSITY		0x12	MSB				LSB			
			OUTPUT O5 INTENSITY				OUTPUT O4 INTENSITY			
Write output O5, O4 intensity	0		O5I3	O5I2	O5I1	O5I0	O4I3	O4I2	O4I1	O4I0
Read-back output O5, O4 intensity	1									
OUTPUTS O7, O6 INTENSITY		0x13	MSB				LSB			
			OUTPUT O7 INTENSITY				OUTPUT O6 INTENSITY			
Write output O7, O6 intensity	0		O7I3	O7I2	O7I1	O7I0	O6I3	O6I2	O6I1	O6I0
Read-back output O7, O6 intensity	1									
OUTPUT O8 INTENSITY			See master, O8 intensity register (Table 11).							

9-Output LED Driver with Intensity Control and Hot-Insertion Protection

Pin Configurations

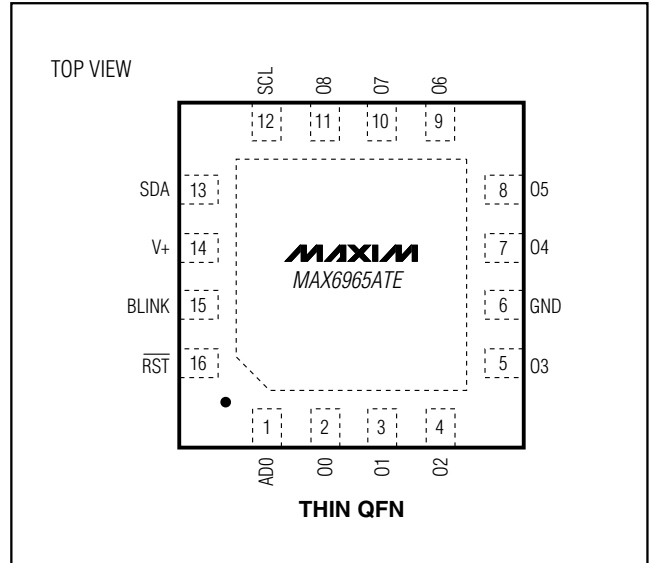
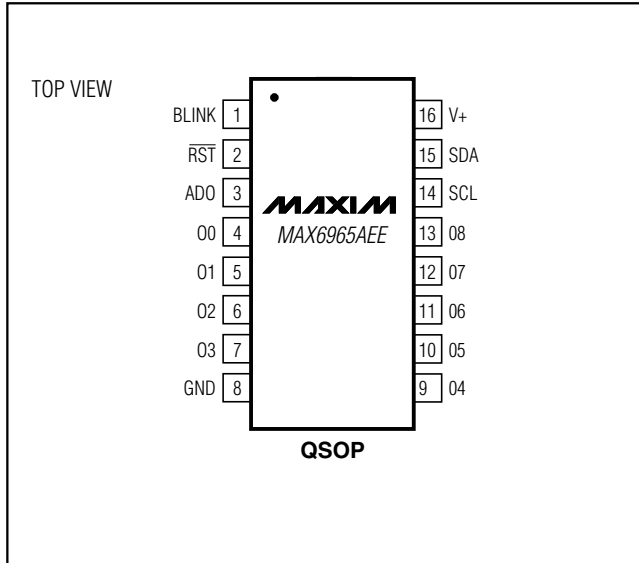

Chip Information

TRANSISTOR COUNT: 17,611
 PROCESS: BiCMOS

9-Output LED Driver with Intensity Control and Hot-Insertion Protection

Package Information

(The package drawing(s) in this data sheet may not reflect the most current specifications. For the latest package outline information, go to www.maxim-ic.com/packages.)

MAX6965

QSOP,LEPS

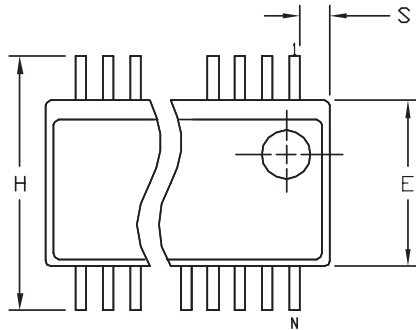

DIM	INCHES		MILLIMETERS	
	MIN	MAX	MIN	MAX
A	.053	.069	1.35	1.75
A1	.004	.010	.102	.254
A2	.049	.065	1.245	1.651
B	.008	.012	0.20	0.30
C	.0075	.0098	0.191	0.249
D	SEE VARIATIONS			
E	.150	.157	3.81	3.99
e	.025 BSC		0.635 BSC	
H	.230	.244	5.84	6.20
h	.010	.016	0.25	0.41
L	.016	.035	0.41	0.89
N	SEE VARIATIONS			
α	0°	8°	0°	8°

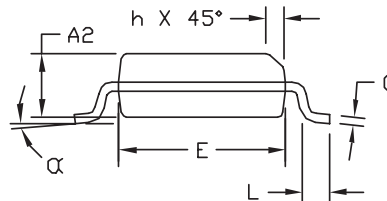
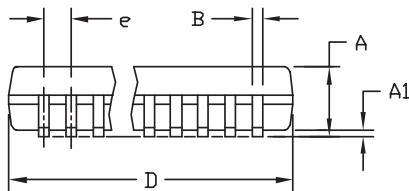

VARIATIONS:

DIM	INCHES		MILLIMETERS		N
	MIN.	MAX.	MIN.	MAX.	
D	.189	.196	4.80	4.98	16 AB
S	.0020	.0070	0.05	0.18	
D	.337	.344	8.56	8.74	20 AD
S	.0500	.0550	1.270	1.397	
D	.337	.344	8.56	8.74	24 AE
S	.0250	.0300	0.635	0.762	
D	.386	.393	9.80	9.98	28 AF
S	.0250	.0300	0.635	0.762	

NOTES:

- 1). D & E DO NOT INCLUDE MOLD FLASH OR PROTRUSIONS.
- 2). MOLD FLASH OR PROTRUSIONS NOT TO EXCEED .006" PER SIDE.
- 3). CONTROLLING DIMENSIONS: INCHES.
- 4). MEETS JEDEC MO137.

<small>PROPRIETARY INFORMATION</small>		
<small>TITLE:</small> PACKAGE OUTLINE, QSOP, .150", .025" LEAD PITCH		
<small>APPROVAL:</small>	<small>DOCUMENT CONTROL NO.</small> 21-0055	<small>REV.</small> F 1/1

9-Output LED Driver with Intensity Control and Hot-Insertion Protection

Package Information (continued)

(The package drawing(s) in this data sheet may not reflect the most current specifications. For the latest package outline information, go to www.maxim-ic.com/packages.)

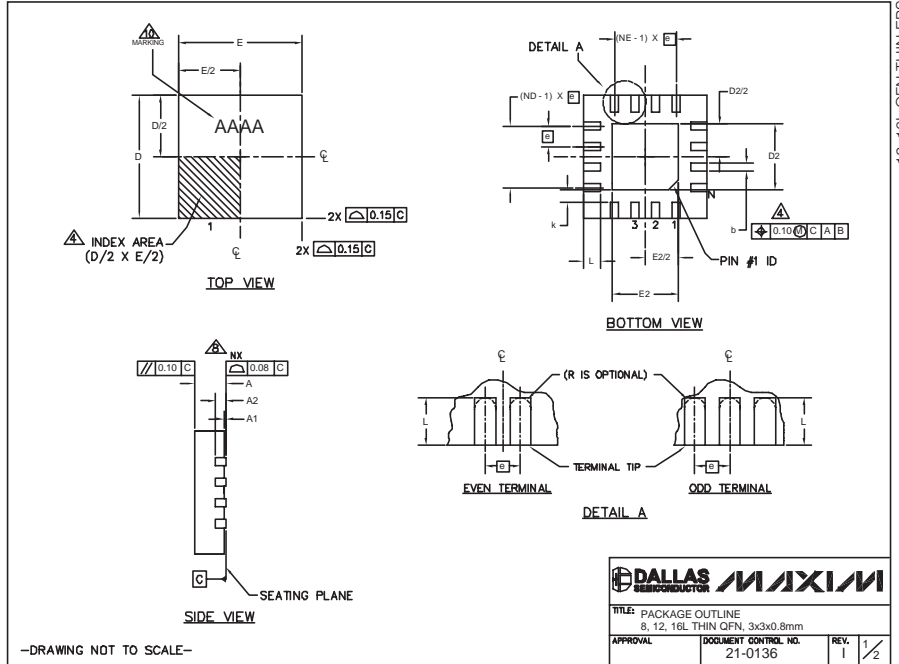

PKG REF.	8L 3x3			12L 3x3			16L 3x3		
	MIN.	NOM.	MAX.	MIN.	NOM.	MAX.	MIN.	NOM.	MAX.
A	0.70	0.75	0.80	0.70	0.75	0.80	0.70	0.75	0.80
b	0.25	0.30	0.35	0.20	0.25	0.30	0.20	0.25	0.30
D	2.90	3.00	3.10	2.90	3.00	3.10	2.90	3.00	3.10
E	2.90	3.00	3.10	2.90	3.00	3.10	2.90	3.00	3.10
e	0.65 BSC.			0.50 BSC.			0.50 BSC.		
L	0.35	0.55	0.75	0.45	0.55	0.65	0.30	0.40	0.50
N	8			12			16		
ND	2			3			4		
NE	2			3			4		
A1	0	0.02	0.05	0	0.02	0.05	0	0.02	0.05
A2	0.20 REF			0.20 REF			0.20 REF		
k	0.25	-	-	0.25	-	-	0.25	-	-

PKG. CODES	D2			E2			PIN ID	JEDEC
	MIN.	NOM.	MAX.	MIN.	NOM.	MAX.		
TQ833-1	0.25	0.70	1.25	0.25	0.70	1.25	0.35 x 45°	WEEC
T1233-1	0.95	1.10	1.25	0.95	1.10	1.25	0.35 x 45°	WEED-1
T1233-3	0.95	1.10	1.25	0.95	1.10	1.25	0.35 x 45°	WEED-1
T1233-4	0.95	1.10	1.25	0.95	1.10	1.25	0.35 x 45°	WEED-1
T1633-2	0.95	1.10	1.25	0.95	1.10	1.25	0.35 x 45°	WEED-2
T1633F-3	0.65	0.80	0.95	0.65	0.80	0.95	0.225 x 45°	WEED-2
T1633FH-3	0.65	0.80	0.95	0.65	0.80	0.95	0.225 x 45°	WEED-2
T1633-4	0.95	1.10	1.25	0.95	1.10	1.25	0.35 x 45°	WEED-2
T1633-5	0.95	1.10	1.25	0.95	1.10	1.25	0.35 x 45°	WEED-2

NOTES:

- DIMENSIONING & TOLERANCING CONFORM TO ASME Y14.5M-1994.
- ALL DIMENSIONS ARE IN MILLIMETERS. ANGLES ARE IN DEGREES.
- N IS THE TOTAL NUMBER OF TERMINALS.
- THE TERMINAL #1 IDENTIFIER AND TERMINAL NUMBERING CONVENTION SHALL CONFORM TO JEDEC 95-1 SPP-012. DETAILS OF TERMINAL #1 IDENTIFIER ARE OPTIONAL, BUT MUST BE LOCATED WITHIN THE ZONE INDICATED. THE TERMINAL #1 IDENTIFIER MAY BE EITHER A MOLD OR MARKED FEATURE.
- DIMENSION b APPLIES TO METALLIZED TERMINAL AND IS MEASURED BETWEEN 0.20 mm AND 0.25 mm FROM TERMINAL TIP.
- ND AND NE REFER TO THE NUMBER OF TERMINALS ON EACH D AND E SIDE RESPECTIVELY.
- DEPOPULATION IS POSSIBLE IN A SYMMETRICAL FASHION.
- COPLANARITY APPLIES TO THE EXPOSED HEAT SINK SLUG AS WELL AS THE TERMINALS.
- DRAWING CONFORMS TO JEDEC MO220 REVISION C.
- MARKING IS FOR PACKAGE ORIENTATION REFERENCE ONLY.
- NUMBER OF LEADS SHOWN ARE FOR REFERENCE ONLY.
- WARPAGE NOT TO EXCEED 0.10mm.

DALLAS SEMICONDUCTOR		MAXIM	
TITLE: PACKAGE OUTLINE 8, 12, 16L THIN OFN, 3x3x0.8mm			
APPROVAL	DOCUMENT CONTROL NO.	REV.	2
	21-0136	1	1/2

-DRAWING NOT TO SCALE-

Maxim cannot assume responsibility for use of any circuitry other than circuitry entirely embodied in a Maxim product. No circuit patent licenses are implied. Maxim reserves the right to change the circuitry and specifications without notice at any time.

22 Maxim Integrated Products, 120 San Gabriel Drive, Sunnyvale, CA 94086 408-737-7600