

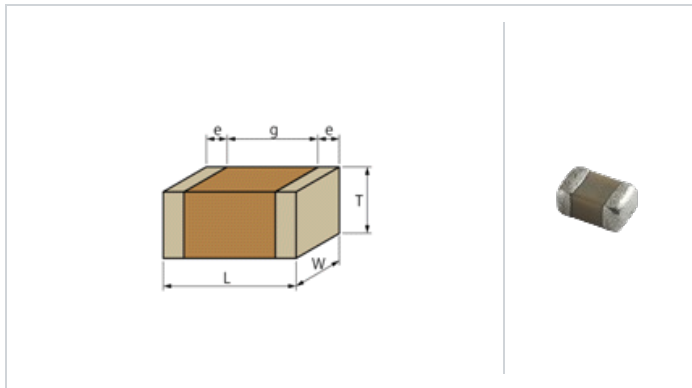

< List of part numbers with package codes >

GR331AD72W153KW01D , GR331AD72W153KW01J

Shape



L size	3.2 ±0.2mm
W size	1.6 ±0.2mm
T size	1.0 +0.0/-0.3mm
External terminal width e	0.3mm min.
Distance between external terminals g	1.2mm min.
Size code in inch(mm)	1206 (3216M)

Notes

Large Capacitance and High Allowable Ripple Current

References

Packaging	Specifications	Minimum quantity
D	φ180mm Paper taping	4000
J	φ330mm Paper taping	10000

Mass (typ.)	
1 piece	34mg

Specifications

Capacitance	15000pF ±10%
Rated voltage	450Vdc
Temperature characteristics (complied standard)	X7T(EIA)
Capacitance change rate	+22.0/-33.0%
Temperature range of temperature characteristics	-55 to 125°C
Operating temperature range	-55 to 125°C

Attention

- 1.This datasheet is downloaded from the website of Murata Manufacturing Co., Ltd. Therefore, it's specifications are subject to change or our products in it may be discontinued without advance notice. Please check with our sales representatives or product engineers before ordering.
- 2.This datasheet has only typical specifications because there is no space for detailed specifications. Therefore, please review our product specifications or consult the approval sheet for product specifications before ordering.