



### I6A Series DC/DC Power Modules 9-40V Input, 14A Output 250W 1/16<sup>th</sup> Brick Power Module

I6A24 power modules perform local voltage conversion from either a 12V or 24V bus. The i6A24014A033V utilizes a low component count that results in both a low cost structure and a high level of performance. The open-frame, compact, design features a low profile and weight that allow for extremely flexible and robust manufacturing processes. The ultra-high efficiency allows for a high output power rating that is truly usable even in demanding thermal environments.

#### Features

- Size – 33mm x 22.9 mm x 12.7 mm (1.3 in. x 0.9 in. x 0.5 in.)
- Maximum weight 15g (0.53 oz)
- Thru-hole pins 3.68mm (0.145")
- Industry standard 1/16<sup>th</sup> brick form factor
- Up to 250W of output power in high ambient temperature, low airflow environments with minimal power derating
- Wide output voltage adjustment range (3.3V – 24V)
- Negative logic on/off
- Optimized dynamic voltage response with minimal external capacitors
- Low noise
- Constant switching frequency
- Remote Sense
- Full, auto-recovery protection:
  - Input under voltage
  - Short circuit
  - Thermal limit
- ISO Certified manufacturing facilities

#### Optional Features

- Positive logic on/off
- Power Good
- Frequency Synchronization
- Output voltage sequencing
- Short 2.79mm (0.110") pin length
- Long 4.57mm (0.180") pin length

#### Applications

- Contact technical support for applications requiring constant current operation

This page intentionally left blank.

### Mechanical Specification:

Dimensions are in mm [in]. Unless otherwise specified tolerances are:  $x.x \pm 0.5$  [0.02],  $x.xx \pm 0.25$  [0.010]

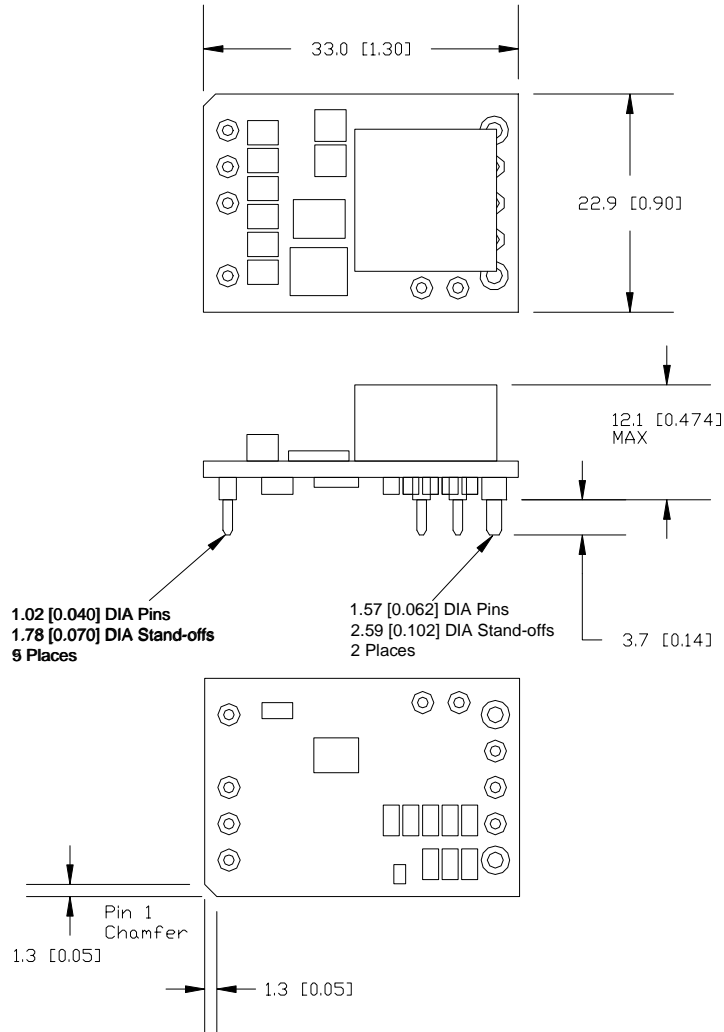

### Recommended Hole Pattern – Standard (top view):

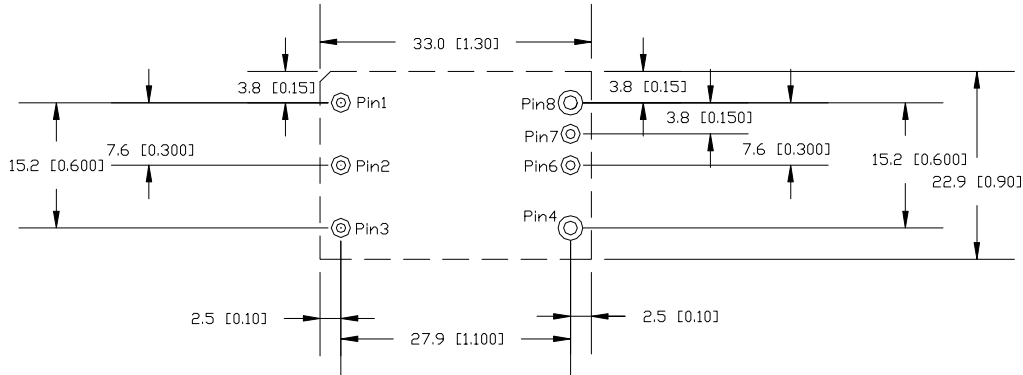

### Recommended Hole Pattern - Full Feature (top view):

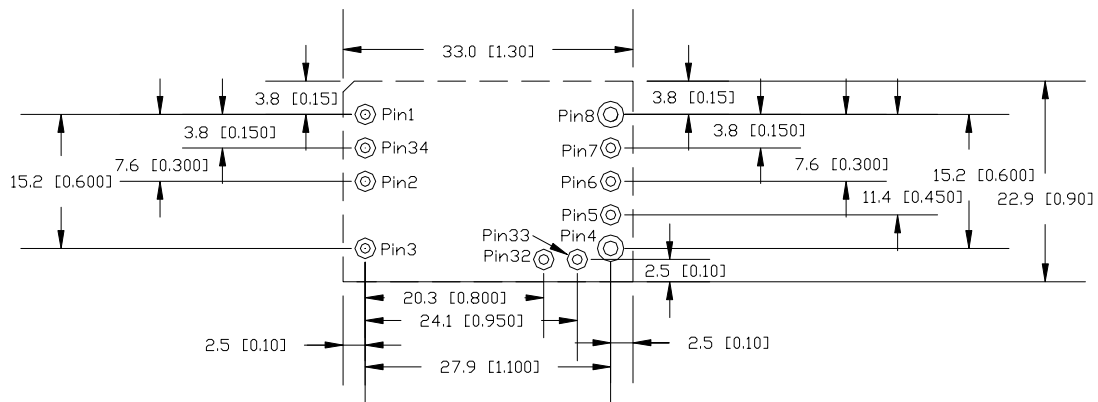

### Pin Assignment:

PIN	FUNCTION	PIN	FUNCTION
1	Vin (+)	7	SENSE +
2	On/Off	8	Vout (+)
3	Vin (-) / GND	32	Sync (option)
4	Vout (-) / GND	33	MS (option)
5	Power Good (option)	34	Sequence (option)
6	TRIM		

Pin base material is brass or copper with gold over nickel plating; the maximum module weight is 15g (0.53 oz).

### Absolute Maximum Ratings:

Stress in excess of Absolute Maximum Ratings may cause permanent damage to the device.

Characteristic	Min	Max	Unit	Notes & Conditions
Continuous Input Voltage	-0.25	50	Vdc	
Isolation Voltage	---	---	Vdc	None
Storage Temperature	-55	125	°C	
Operating Temperature Range (Tc)	-40	125*	°C	Measured at the location specified in the thermal measurement figure; maximum temperature varies with output current – see curve in the thermal performance section of the data sheet.

\* Engineering estimate

### Input Characteristics:

Unless otherwise specified, specifications apply over all rated Input Voltage, Resistive Load, and Temperature conditions.

Characteristic	Min	Typ	Max	Unit	Notes & Conditions
Operating Input Voltage	10	---	40	Vdc	
Maximum Input Current	---	---	15	A	Vin= Vin,min to Vin,max; Io=Io,max
Startup Delay Time from application of input voltage	---	4	---	mS	Vo=0 to 0.1*Vo,set; on/off=on, Io=Io,max, Tc=25°C
Startup Delay Time from on/off	---	3	---	mS	Vo=0 to 0.1*Vo,set; Vin=Vi,nom, Io=Io,max, Tc=25°C
Output Voltage Rise Time	---	10	---	mS	Io=Io,max, Tc=25°C, Vo=0.1 to 0.9*Vo,set
Input Ripple Rejection	---	50*	---	dB	@ 120 Hz
Turn on input voltage	---	8	---	V	
Turn off input voltage	---	7	9	V	

\*Engineering Estimate

Caution: The power modules are not internally fused. An external input line normal blow fuse with a maximum value of 30A is required, see the Safety Considerations section of the data sheet.

### Electrical Data:

Characteristic	Min	Typ	Max	Unit	Notes & Conditions	
Output Voltage Initial Setpoint	-2	-	+2	%	Vo=3.3Vsetting, Vin=Vin,nom; Io=Io,min; Tc = 25°C	
Output Voltage Tolerance	-4	-	+4	%	Over all rated input voltage, load, and temperature conditions to end of life	
Efficiency	Vo = 3.3V	---	92.5	---	%	Vin=12V; Io=Io,max; Tc=25°C
	Vo = 5V	---	94.5	---	%	
	Vo = 8V	---	96	---	%	
Efficiency	Vo = 5V	---	92.5	---	%	Vin=24V; Io=Io,max; Tc=25°C
	Vo = 12V	---	96.5	---	%	
	Vo = 15V	---	97	---	%	
	Vo = 20V	---	98	---	%	
Line Regulation	---	0.3	---	%	Vin=Vin,min to Vin,max	
Load Regulation	---	1	---	%	Io=Io,min to Io,max	
Output Current	0	---	14	A	Observe maximum power limit	
Output Current Limiting Threshold	---	22	---	A	Vo = 0.9*Vo,nom, Tc<Tc,max	
Short Circuit Current	---	0.5	---	A	Vo = 0.25V, Tc = 25°C	
Output Ripple and Noise Voltage	---	20	---	mVpp	Measured across one 0.1 uF ceramic capacitor and one 22uF ceramic capacitor – see input/output ripple measurement figure; BW = 20MHz.	
Output Voltage Adjustment Range	3.3	---	24	V		
Output Voltage Sense Range	---	---	5	%		
Dynamic Response: Recovery Time	---	50	---	uS	di/dt =1A/uS, Vin=Vin,nom; Vo=12V, load step from 25% to 75% of Io,max	
Transient Voltage	---	500	---	mV		
Switching Frequency	---	400	---	kHz	Fixed	
External Load Capacitance	0	---	2000*	uF		
Vref	---	0.6	---	V	Required for trim calculation	
F	---	36500	---	Ω	Required for trim calculation	
G	---	511	---	Ω	Required for trim calculation	

\*Please contact TDK - Lambda Americas for technical support for very low esr capacitor banks or if higher capacitance is required

### Electrical Characteristics:

#### Typical Efficiency vs. Input Voltage

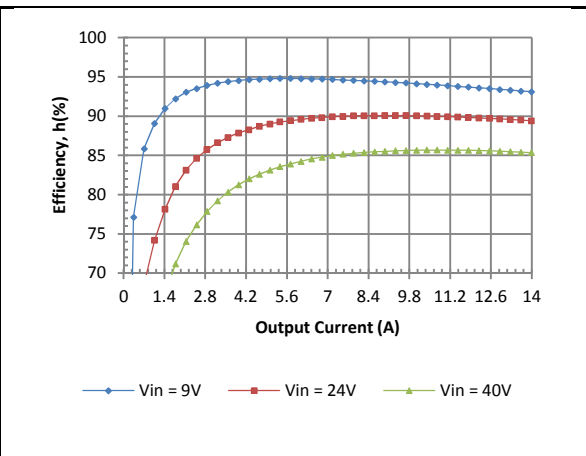
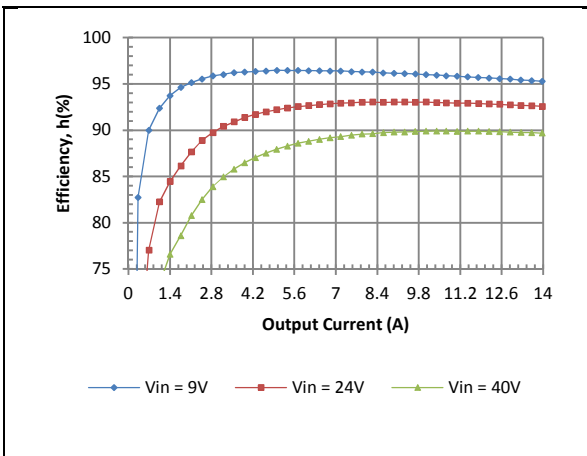
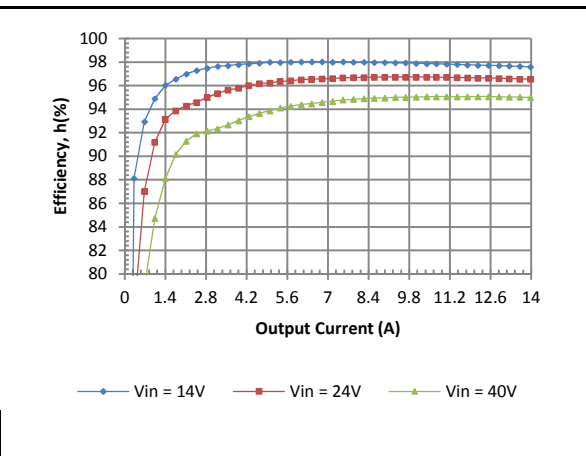
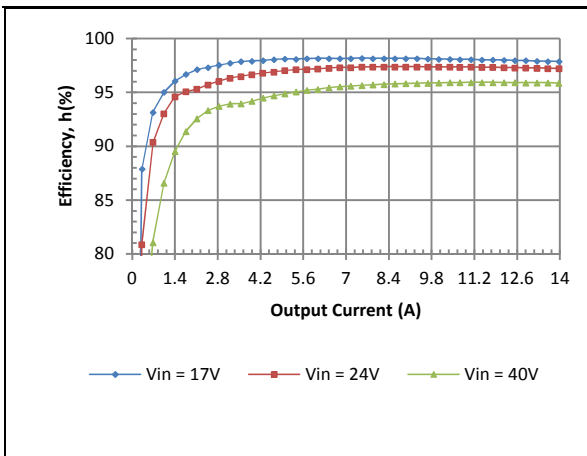
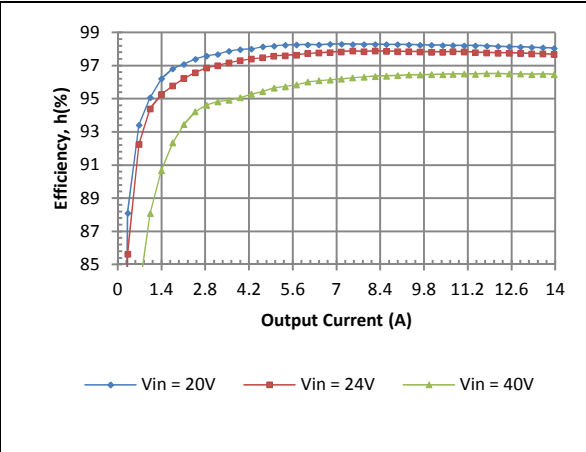
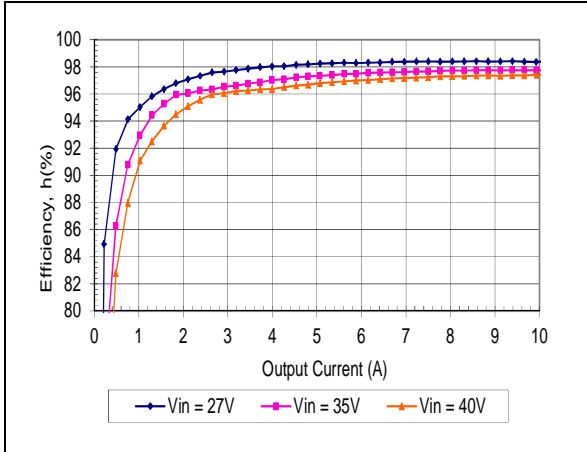

### Electrical Characteristics:

#### Typical Power Dissipation vs. Input Voltage

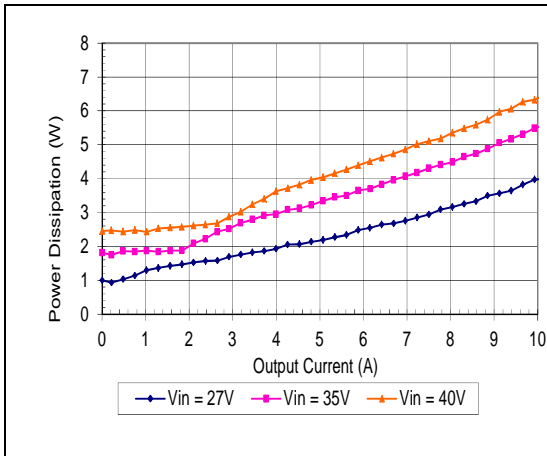

$V_o = 24V$

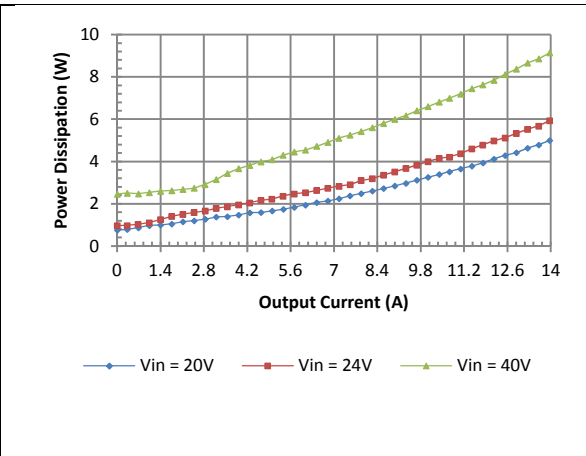

$V_o = 18V$

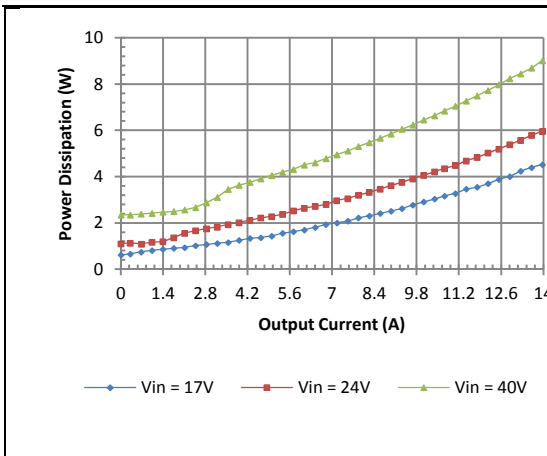

$V_o = 15V$

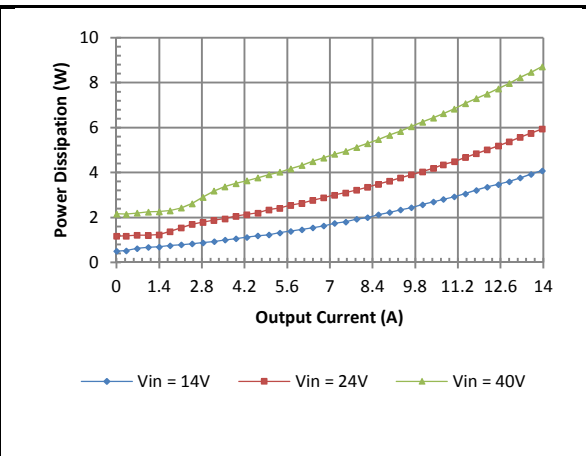

$V_o = 12V$

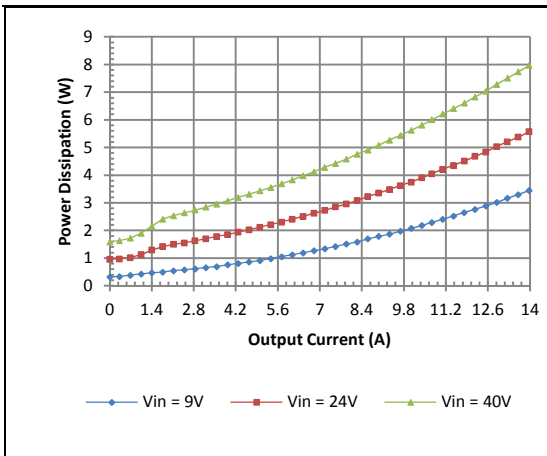

$V_o = 5V$

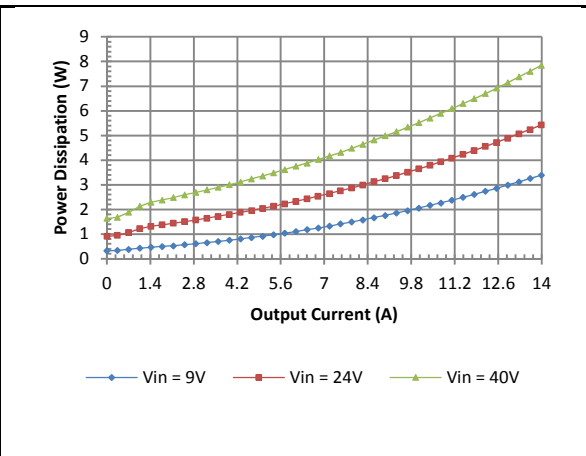

$V_o = 3.3V$



### Electrical Characteristics:

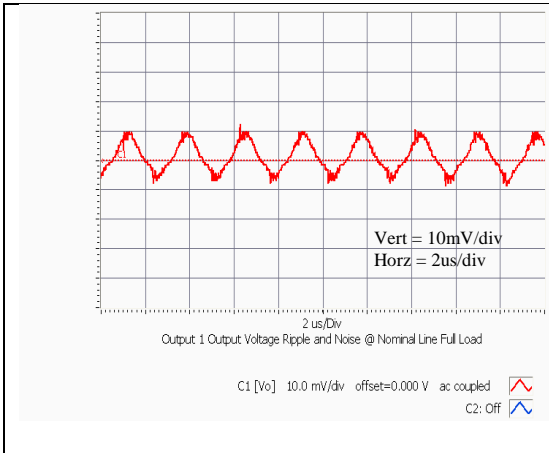

Vo=12V Typical Output Ripple at nominal Input voltage and full load at Ta=25 degrees

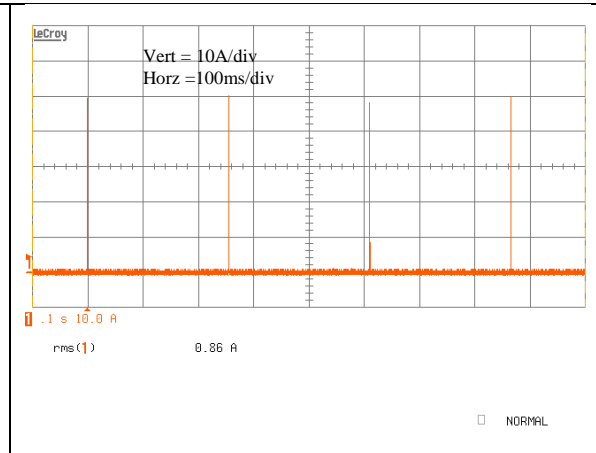

Typical Output Short Circuit Current – CH1, orange

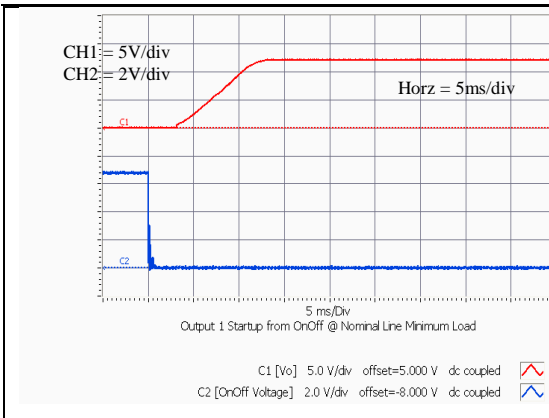

Vo=12V Typical startup characteristic from on/off at full load. Ch1 - output voltage, Ch2 – on/off signal

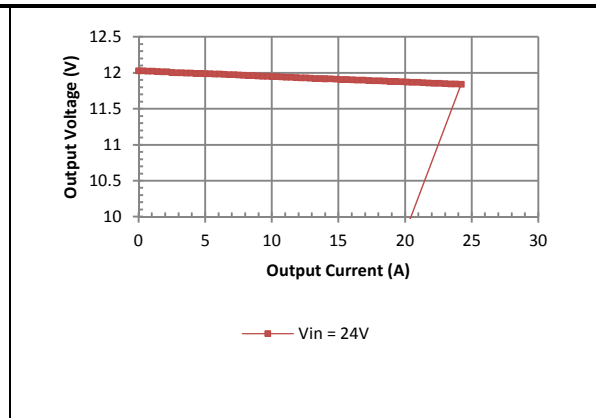

Vo=12V Typical Current Limit Characteristics

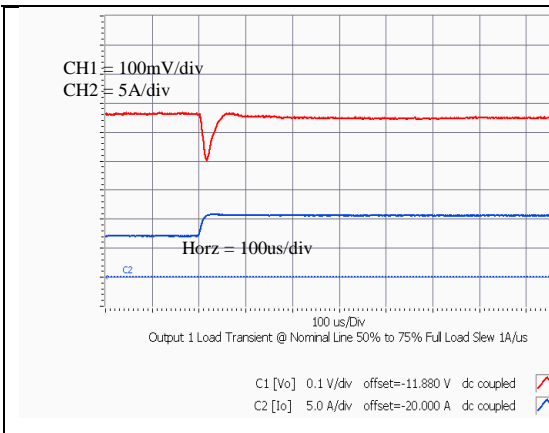

Vo=12V Typical output voltage transient response to load step from 50% to 75% of full load with output current slew rate of 1A/uS. (Cext = 3x47uF ceramic capacitor)

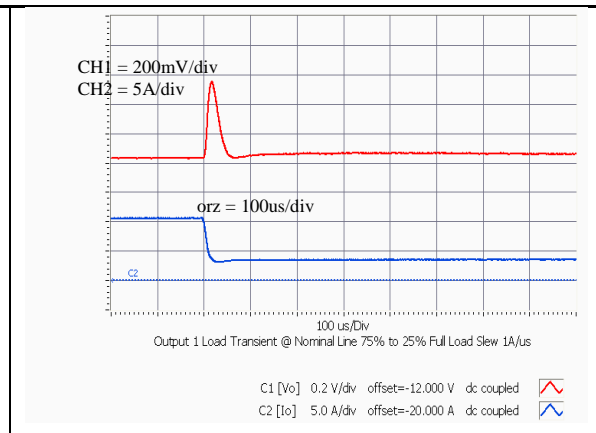

Vo=12V Typical output voltage transient response to load step from 75% to 25% of full load with output current slew rate of 1A/uS. (Cext = 3x47uF ceramic capacitor)

### Electrical Characteristics:

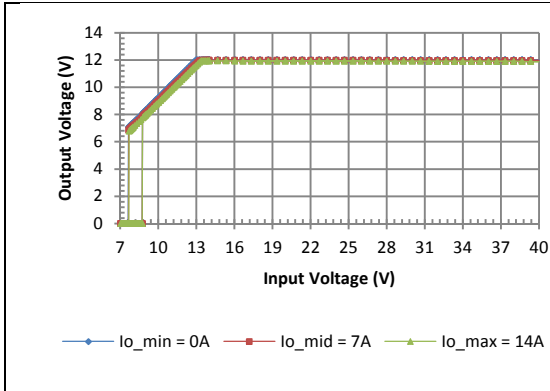

Vo=12V Typical Output Voltage vs. Input Voltage Characteristics

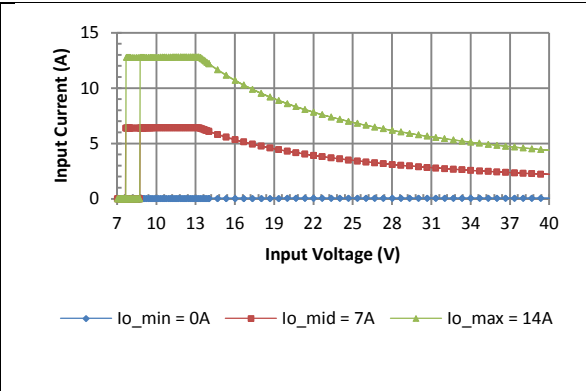

Vo=12V Typical Input Current vs. Input Voltage Characteristics

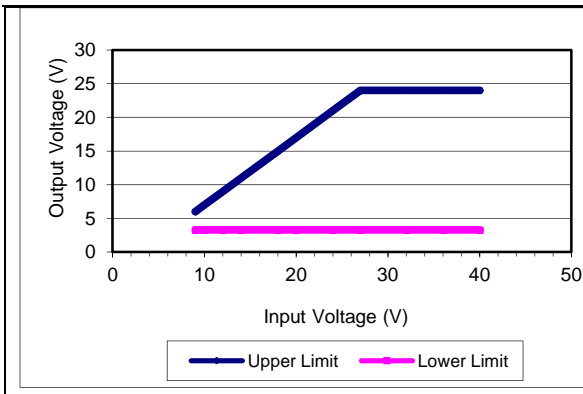

Output Voltage versus Input Voltage Operating Range

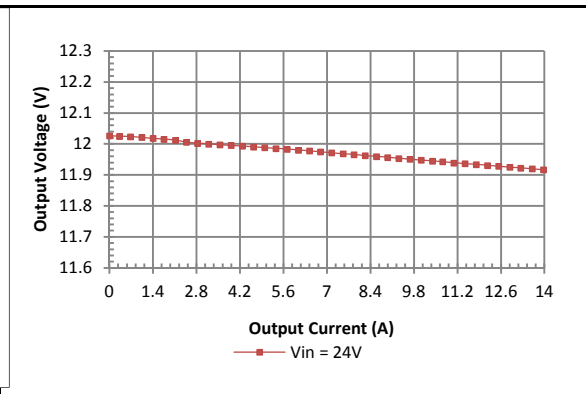

Vo=12V Typical load regulation

Intentionally blank

Intentionally blank

### Thermal Performance:

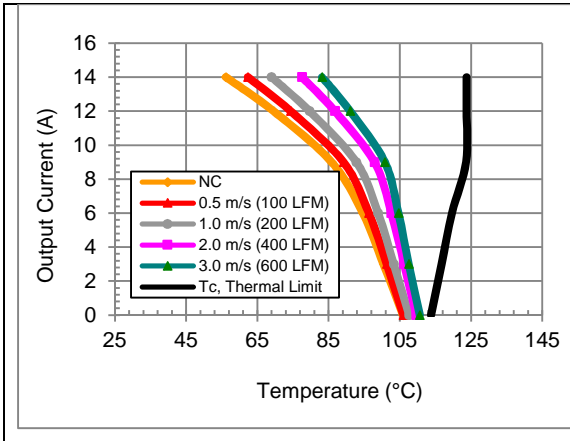

$V_o=18V$ ,  $V_{in}=24V$  preliminary maximum output current vs. ambient temperature at nominal input voltage for natural convection (60lfm) with airflow from pin 8 to pin 4.

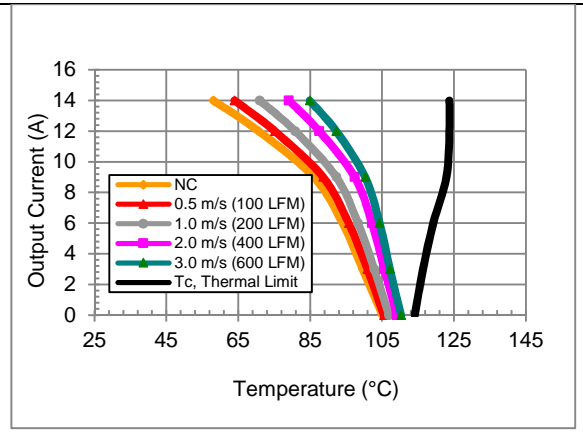

$V_o=12V$ ,  $V_{in}=24V$  preliminary maximum output current vs. ambient temperature at nominal input voltage for natural convection (60lfm) with airflow from pin 8 to pin 4.

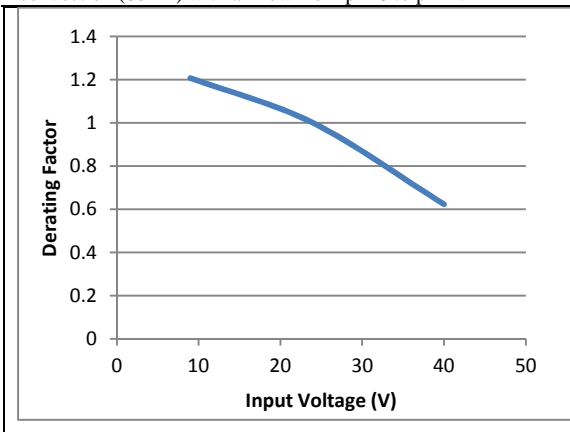

Typical ambient temperature derating versus line voltage with airflow 1m/s (200 lfm)

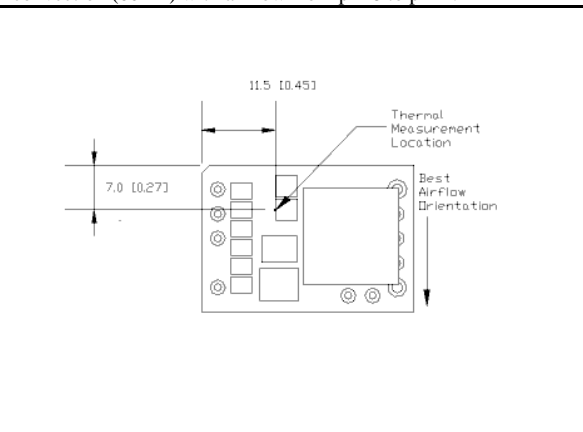

i6A24014A033V thermal measurement location – top view

The thermal curves provided are based upon measurements made in TDK - Lambda Americas' experimental test setup that is described in the Thermal Management section. Due to the large number of variables in system design, TDK - Lambda Americas recommends that the user verify the module's thermal performance in the end application. The critical component should be thermo coupled and monitored, and should not exceed the temperature limit specified in the derating curve above. It is critical that the thermocouple be mounted in a manner that gives direct thermal contact or significant measurement errors may result. TDK - Lambda Americas can provide modules with a thermocouple pre-mounted to the critical component for system verification tests.

### Thermal Management:

An important part of the overall system design process is thermal management; thermal design must be considered at all levels to ensure good reliability and lifetime of the final system. Superior thermal design and the ability to operate in severe application environments are key elements of a robust, reliable power module.

A finite amount of heat must be dissipated from the power module to the surrounding environment. This heat is transferred by the three modes of heat transfer: convection, conduction and radiation. While all three modes of heat transfer are present in every application, convection is the dominant mode of heat transfer in most applications. However, to ensure adequate cooling and proper operation, all three modes should be considered in a final system configuration.

The open frame design of the power module provides an air path to individual components. This air path improves convection cooling to the surrounding environment, which reduces areas of heat concentration and resulting hot spots.

**Test Setup:** The thermal performance data of the power module is based upon measurements obtained from a wind tunnel test with the setup shown in the wind tunnel figure. This thermal test setup replicates the typical thermal environments encountered in most modern electronic systems with distributed power architectures. The electronic equipment in networking, telecom, wireless, and advanced computer systems operates in similar environments and utilizes vertically mounted PCBs or circuit cards in cabinet racks.

The power module, as shown in the figure, is mounted on a printed circuit board (PCB) and is vertically oriented within the wind tunnel. The cross section of the airflow passage is rectangular. The spacing between the top of the module and a parallel facing PCB is kept at a constant (0.5 in). The power module's orientation with respect to the airflow direction can have a significant impact on the module's thermal performance.

**Thermal Derating:** For proper application of the power module in a given thermal environment, output current derating curves are provided as a design guideline on the Thermal Performance section for the

power module of interest. The module temperature should be measured in the final system configuration to ensure proper thermal management of the power module. For thermal performance verification, the module temperature should be measured at the component indicated in the thermal measurement location figure on the thermal performance page for the power module of interest. In all conditions, the power module should be operated below the maximum operating temperature shown on the derating curve. For improved design margins and enhanced system reliability, the power module may be operated at temperatures below the maximum rated operating temperature.

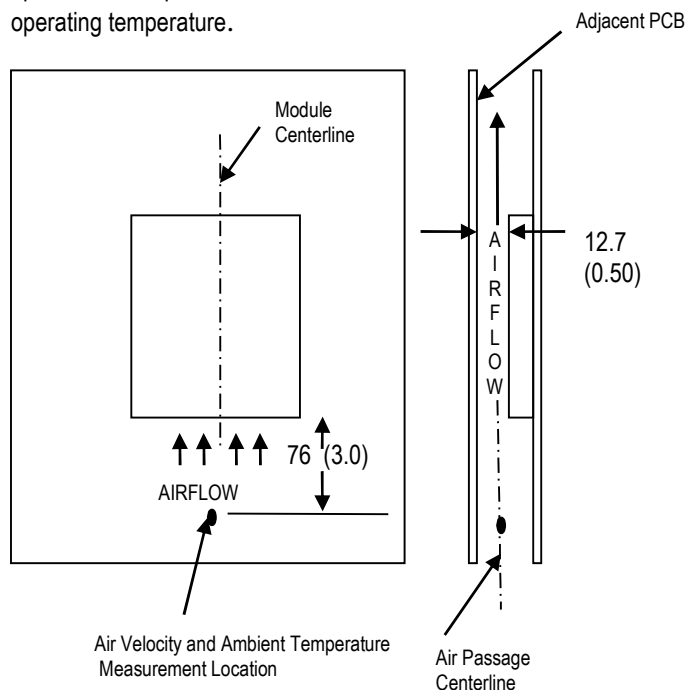

**Wind Tunnel Test Setup Figure** Dimensions are in millimeters and (inches).

Heat transfer by convection can be enhanced by increasing the airflow rate that the power module experiences. The maximum output current of the power module is a function of ambient temperature ( $T_{AMB}$ ) and airflow rate as shown in the thermal performance figures on the thermal performance page for the power module of interest. The curves in the figures are shown for natural convection through 2 m/s (400 ft/min). The data for the natural convection condition has been collected at 0.3 m/s (60 ft/min) of airflow, which is the typical airflow generated by other heat dissipating components in many of the systems that these types of modules are used in. In the final system configurations, the airflow rate for the natural convection condition can vary due to temperature gradients from other heat dissipating components.

### Operating Information:

**Over-Current Protection:** The power modules have short circuit protection to protect the module during severe overload conditions. During overload conditions, the power modules may protect themselves by entering a hiccup current limit mode. The modules will operate normally once the output current returns to the specified operating range. Long term operation outside the rated conditions and prior to the hiccup protection engaging is not recommended unless measures are taken to ensure the module's thermal limits are being observed.

**Remote On/Off:** - The power modules have an internal remote on/off circuit. The user must supply compatible switch between the GND pin and the on/off pin. The maximum voltage generated by the power module at the on/off terminal is  $V_{in,max}$ . The maximum allowable leakage current of the switch is 10  $\mu$ A. The switch must be capable of maintaining a low signal  $V_{on/off} < 0.25V$  while sinking 1mA.

The standard on/off logic is positive logic. In the circuit configuration shown the power module will turn off if the external switch is on and it will be on if the switch is off and the on/off pin is open. If the positive logic feature is not being used, terminal 2 should be left open. A voltage source should not be applied to the on/off terminal.

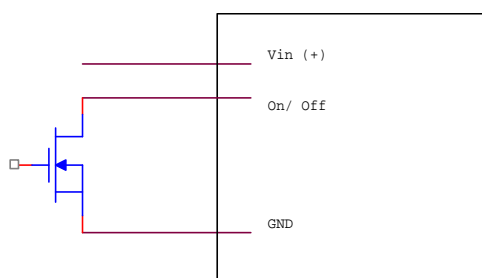

On/Off Circuit for positive or negative logic

An optional negative logic is available. In the circuit configuration shown the power module will turn on if the external switch is on and it will be off if the external switch is off. If the negative logic feature is not being used, terminal 2 should be connected to ground.

**Remote Sense:** The power modules feature remote sense to compensate for the effect of output distribution drops. The output voltage sense range defines the maximum voltage allowed between the output power and sense terminals, and it is found on the electrical data page for the power module of interest. If the remote sense feature is not being used, the Sense terminal should be connected to the  $V_o$  terminal.

The output voltage at the  $V_o$  terminal can be increased by either the remote sense or the output voltage adjustment feature. The maximum voltage increase allowed is the larger of the remote sense range or the output voltage adjustment range; it is not the sum of both. As the output voltage increases due to the use of the remote sense, the maximum output current may need to be decreased for the power module to remain below its maximum power rating.

**Power Good:** The power module features an open-drain power good signal which indicates if the output voltage is being regulated. When power is applied to the module, but the output voltage is typically more than  $\pm 12\%$  from the nominal voltage set point due to input under voltage, over temperature, over load, or loss of control the power good will be pulled to ground through a 75 ohm maximum impedance. A 10kohm resistor is recommended if pulling up to 3.3V source. The voltage on the power good pin should be limited to less than 6V in all cases. If the power good feature is not used, the pin should be left open.

**Output Voltage Adjustment:** The output voltage of the power module may be adjusted by using an external resistor connected between the Vout trim terminal and GND terminal. If the output voltage adjustment feature is not used, trim terminal should be left open. Care should be taken to avoid injecting noise into the power module's trim pin.

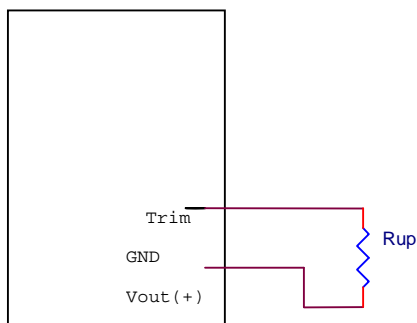

### Circuit to increase output voltage

With a resistor between the trim and GND terminals, the output voltage is adjusted up. To adjust the output voltage from  $V_{o,nom}$  to  $V_{o,up}$  the trim resistor should be chosen according to the following equation:

$$R_u := \left( \frac{V_{ref} \cdot F}{V_{oup} - V_{onom}} \right) - G$$

The values of  $V_{ref}$ ,  $G$  and  $F$  are found in the electrical data section for the power module of interest. The maximum power available from the power module is fixed. As the output voltage is trimmed up, the maximum output current must be decreased to maintain the maximum rated power of the module.

e.g.  $V_o = 5V$

$$R_u := \left( \frac{0.636500}{5 - 0.6} \right) - 511$$

Vout (V)	Ru (Kohm)
3.3	7.6
5	4.47
9.6	1.92
12	1.41
15	1.0
18	0.75

**Synchronization:** The i6A modules can be synchronized to one another or to an external clock within +/- 20% of nominal value shown on electrical characteristics page by using pin 32(SYNC) and pin 33 (MS). Interleaving of switching can also be achieved to achieve input noise cancellation.

If MS pin is tied to  $V_{in}$  pin it will become a clock master. In this mode pin 32 (Sync) will become a clock output that can be used to synchronize other i6A power modules.

If MS pin is left open then pin 32 (sync) will become a clock input and the module will synchronize to the clock signal with no phase shift.

If MS pin is tied to GND then pin 32 (sync) will become a clock input and the module will synchronize to the clock signal with 180 degree phase shift.

If an external clock signal is being used, it is recommended to use a 5k resistor from sync pin to clock and limit clock signal slew rate to 10V/us. The sync signal should be 50% duty cycle square wave with 2V minimum logic high and 0.8V maximum for logic low.

**Sequencing:** The sequence pin 34, is used for output voltage tracking. The voltage sequencing feature enables the user to implement various types of power up and power down sequencing schemes including sequential startup, ratiometric startup, and simultaneous startup. If the sequencing feature is not being used, the Seq pin should be connected by a 10K resistor to a 1.8V - 3.3V source. The voltage on the sequence pin should be limited to less than 3.6V in all cases.

To use the voltage sequencing feature, the module should be set to an On state using the on/off feature. The input voltage should be applied and in the specified operating range for 15mS. After the 15mS interval, an analog voltage can be applied to the Seq pin and the output of the module will track the applied voltage until the output reaches its set point voltage. The final sequencing voltage must be higher than the reference voltage shown in the electrical characteristics table. For sequential shut down, the Seq pin voltage should be lowered. The module output voltage will decrease as the sequence pin voltage is lowered.

For assistance using the voltage sequencing function, please contact TDK - Lambda Americas' technical support.

**EMC Considerations:** TDK - Lambda Americas' power modules are designed for use in a wide variety of systems and applications. For assistance with designing for EMC compliance, please contact TDK - Lambda Americas technical support.

**Input Impedance:**

The source impedance of the power feeding the DC/DC converter module will interact with the DC/DC converter. To minimize the interaction, low-esr capacitors should be located at the input to the module. It is recommended that a 33uF-100uF input capacitor be placed near the module.

**Reliability:**

The power modules are designed using TDK - Lambda Americas' stringent design guidelines for component derating, product qualification, and design reviews. The MTBF is calculated to be greater than 12 million hours at full output power and  $T_a = 40^{\circ}\text{C}$  using the Telcordia SR-332 calculation method.

**Quality:**

TDK - Lambda Americas' product development process incorporates advanced quality planning tools such as FMEA and Cpk analysis to ensure designs are robust and reliable. All products are assembled at ISO certified assembly plant

**Input/Output Ripple and Noise Measurements:**

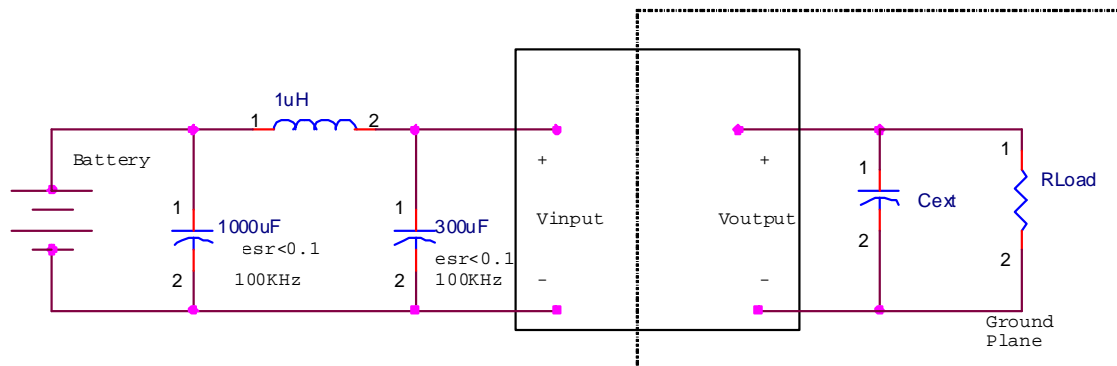

The input reflected ripple is measured with a current probe and oscilloscope. The ripple current is the current through the 1uH inductor.

The output ripple measurement is made approximately 9 cm (3.5 in.) from the power module using an oscilloscope and BNC socket. The capacitor Cext is located about 5 cm (2 in.) from the power module; its value varies from code to code and is found on the electrical data page for the power module of interest under the ripple & noise voltage specification in the Notes & Conditions column.

### Safety Considerations:

As of the publishing date, certain safety agency approvals may have been received on the i6A series and others may still be pending. Check with TDK - Lambda Americas for the latest status of safety approvals on the i6A product line.

For safety agency approval of the system in which the DC-DC power module is installed, the power module must be installed in compliance with the creepage and clearance requirements of the safety agency.

To preserve maximum flexibility, the power modules are not internally fused. An external input line normal

blow fuse with a maximum value of 30A is required by safety agencies. A lower value fuse can be selected based upon the maximum dc input current and maximum inrush energy of the power module.

### Warranty:

TDK - Lambda Americas' comprehensive line of power solutions includes efficient, high-density DC-DC converters. TDK - Lambda Americas offers a three-year limited warranty. Complete warranty information is listed on our web site or is available upon request from TDK - Lambda Americas.

### **TDK - Lambda Americas Inc.**

401 Mile of Cars Way, Suite 325  
National City, California 91950

Phone (800) 526-2324  
[www.us.tdk-lambda.com/lp](http://www.us.tdk-lambda.com/lp)

Information furnished by TDK - Lambda Americas is believed to be accurate and reliable. However, TDK - Lambda Americas assumes no responsibility for its use, nor for any infringement of patents or other rights of third parties, which may result from its use. No license is granted by implication or otherwise under any patent or patent rights of TDK - Lambda Americas. TDK components' are not designed to be used in applications, such as life support systems, wherein failure or malfunction could result in injury or death. All sales are subject to TDK - Lambda Americas' Terms and Conditions of Sale, which are available upon