

LIN HALL click™

1. Introduction

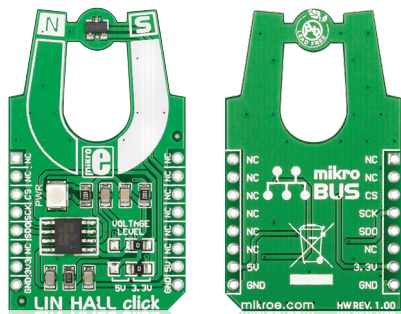

LIN HALL click™ is a simple solution for adding a linear Hall sensor to your design. It carries an MLX90242 linear Hall sensor IC (with built-in active error correction circuitry) and an MCP3201 12-bit ADC. LIN HALL click™ communicates with the target board through the **mikroBUS™** SPI lines (CS, SCK, MISO). The board is designed to use either a 3.3V or 5V power supply.

2. Soldering the headers

Before using your click™ board, make sure to solder 1x8 male headers to both left and right side of the board. Two 1x8 male headers are included with the board in the package.

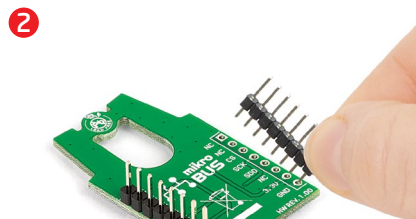
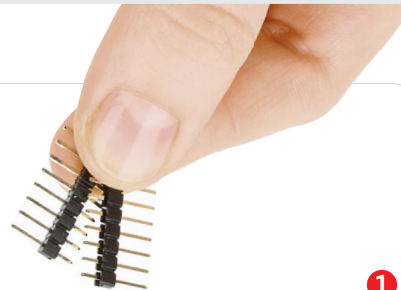

Turn the board upside down so that the bottom side is facing you upwards. Place shorter pins of the header into the appropriate soldering pads.

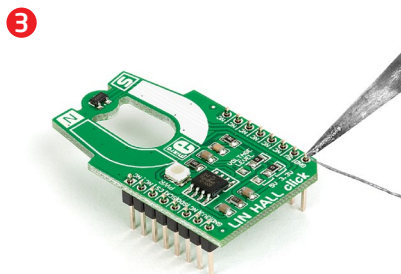

Turn the board upward again. Make sure to align the headers so that they are perpendicular to the board, then solder the pins carefully.

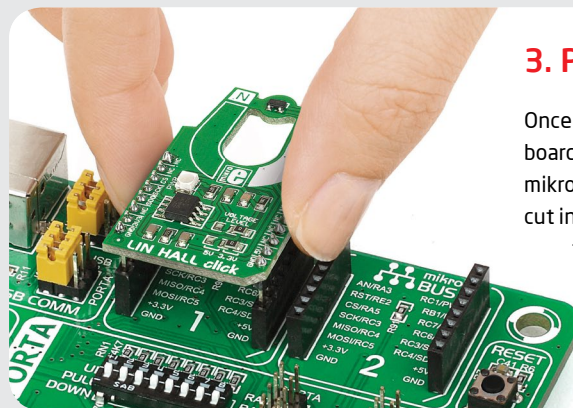

3. Plugging the board in

Once you have soldered the headers your board is ready to be placed into the desired mikroBUS™ socket. Make sure to align the cut in the lower-right part of the board with the markings on the silkscreen at the mikroBUS™ socket. If all the pins are aligned correctly, push the board all the way into the socket.

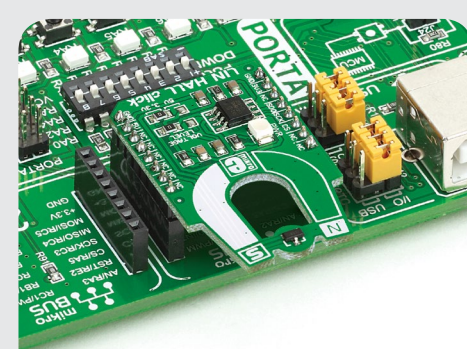

4. Essential features

LIN HALL click™, with its linear Hall sensor, outputs a signal that is proportional to the flux density of a magnetic field. The output signal will increase when a north magnetic field is applied, while a south magnetic field will cause it to decrease. The ratiometric output can be used to measure the strength of different magnets, or to measure the distance between the sensor and a magnet (which can be used for linear or rotary position sensing by placing magnets on the target object).

click™
BOARD
www.mikroe.com

LIN HALL click™ manual
ver. 1.00



5. LIN HALL click™ board schematic

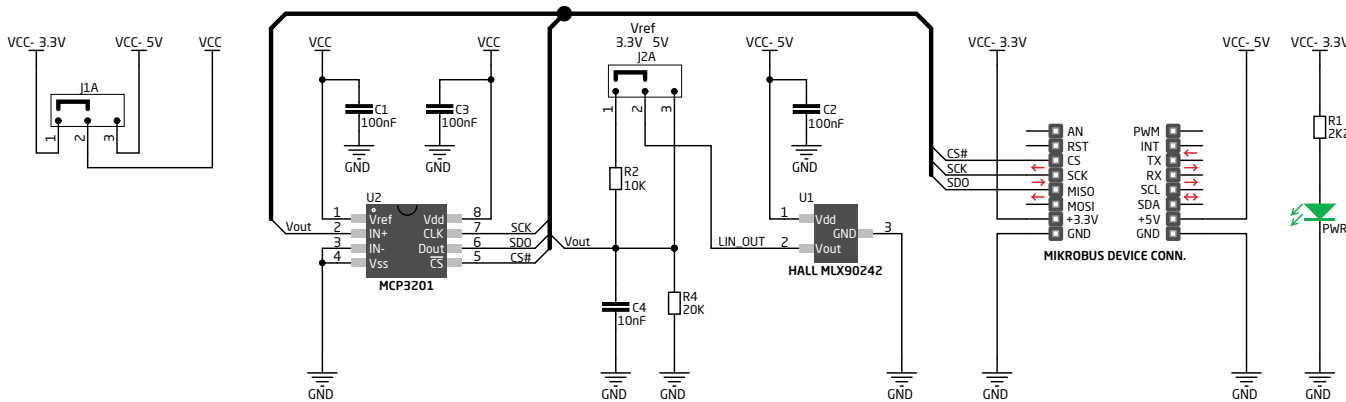

6. SMD jumpers

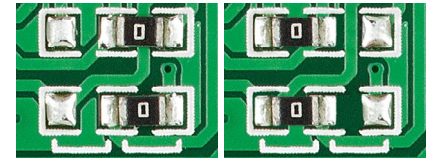

To switch between 3.3V and 5V power supplies, use the on-board zero-ohm SMD jumpers. By default, the two jumpers are soldered in the 3.3V position.

7. Code examples

Once you have done all the necessary preparations, it's time to get your click™ board up and running. We have provided examples for mikroC™, mikroBasic™ and mikroPascal™ compilers on our **Libstock** website. Just download them and you are ready to start.



8. Support

MikroElektronika offers **free tech support** (www.mikroe.com/support) until the end of the product's lifetime, so if something goes wrong, we're ready and willing to help!