

ISL8120EVAL3Z Evaluation Board Setup Procedure

ISL8120EVAL3Z Evaluation Board



FIGURE 1. ISL8120EVAL3Z EVALUATION BOARD

The ISL8120 integrates two voltage-mode synchronous buck PWM controllers. It can be used either for dual independent outputs or a 2-phase single-output regulator.

The ISL8120EVAL3Z evaluation board is for performance demo of the dual independent outputs and DDR applications.

The ISL8120EVAL4Z evaluation board is used for performance demo of 2/n-phase single-output applications. Application note "ISL8120EVAL4Z Evaluation Board Setup Procedure" will soon be available for the ISL8120EVAL4Z board.

Recommended Equipment

- 0V to 22V power supply with at least 20A source current capability, battery, or notebook AC adapter.
- Two Electronic Loads capable of sinking current up to 30A
- Digital multi-meters (DMMs).
- 100MHz quad-trace oscilloscope.

Circuits Description

J1 and J2 are the input power terminals.

Two input electrolytic caps are used to handle the input current ripples.

Two upper and two lower Renesas "speed" series LFPK MOSFETs are used for each channel. Q1 and Q2 are footprint options for low current applications where a SO8 package integrating dual MOSFET can be used.

320nH PULSE surface mount inductors are used for each channel. Under the 500kHz setup, the inductor current peak to peak ripple is 7.5A at 12V input.

Two SANYO POSCAP 2R5TPF470M7L (7mΩ) are used as output E-caps for each channel. Also, through hole electrolytic cap footprints C123 ~ C126 are available for the user to evaluate different output caps.

J7, J8, J9 and J10 are output lugs for load connections.

TP19, TP26, TP28 and TP31 are remote sense posts. These pins can be used to monitor and evaluate the system voltage regulations. If the user want to use these test posts for remote sense, the R109, R120, R155 and R161 need to be changed to higher values, such as 10Ω. Also, the related voltage sense divider needs to be increased to a higher resistance, such as 1k.

Q26, Q27, R126, R156, R122, R131, R151, R153 are circuit footprint options to add a on-board transient load to the regulator. Use a signal generator to apply a clock signal at TP22 (TP30) to generate step up and step down transient load. Make sure that the duty cycle of the clock

is small enough to avoid burning load resistors R126 and R156.

JP11 or JP12 are the jumpers used to disable the channels independently.

TP27 is a post that can be used to inject a clock signal for the controller to be synchronized with.

JP7 and JP8 are jumpers for $r_{DS(ON)}$ sensing configuring. Also, these jumpers can be used to monitor the DCR sensing cap voltage.

R94, C74, R163, and C108 are optional footprints for snubbers which are used to filter the ringing at phase nodes.

R99, R100, R125, R130, R132, LED4 and Q32 are useless footprints.

R121 and C86 are small added filters for the VIN pin. R145 is used to isolate the noise at PVCC caused by driving. In 3.3V applications, R121 and R145, it is recommended to short to 0 to prevent VCC from going below POR under low input voltage. Also, it's recommend to add a 2k resistor from LGATE to GND to discharge the low gate at the state of LGATE OFF.

Quick Start

1. Ensure that the circuit is correctly connected to the supply and loads prior to applying any power.
2. Adjust the input supply to be 12V. Turn on the input power supply.
3. Verify the two outputs' voltages are correct. If the PGOOD is set high, the LED3 will be green. If the PGOOD is set low, the LED3 will be red. TP24 is the test post to monitor PGOOD.

Evaluating the Other Output Voltage

The ISL8120EVAL3Z kit outputs are preset to 1.2V/25A, VOUT1 can also be adjusted between 0.6V to 3V by changing the value of R119 and R116 for VOUT1 as given by Equation 1. The same rule applies for VOUT2.

$$R119 = \frac{R116}{(V_{OUT}/V_{REF}) - 1} \quad \text{where } V_{REF} = 0.6V \quad (\text{EQ. 1})$$

$r_{DS(ON)}$ Sense Configuration

If the desired output voltage is higher than 3V, the current sense has to be configured as $r_{DS(ON)}$ sensing because of the common mode voltage limitation of the current sense differential amplifier. The default setup of ISL8120EVAL3Z is DCR sensing. The following steps show how to change to $r_{DS(ON)}$ sensing for Channel 2:

1. Remove R5 and R6 to be open.
2. Change R4 and R8 to be 0Ω .
3. Short jumper JP1.

Programming the Input Voltage UVLO and its Hysteresis

By programming the voltage divider at the EN/FF pin connected to the input rail, the input UVLO and its hysteresis can be programmed. The ISL8120EVAL3Z has R129(R136) 13.7k and R135(R141) 4.42k; the IC will be disabled when input voltage drops below 3.38V and will restart until V_{IN} recovers to be above 4.42V.

For 12V applications, it's suggested to have R129 (R136) 33k and R135(R141) 5.1k, of which the IC is disabled when the input voltage drops below 6V and will restart until V_{IN} recovers to be above 7V.

Refer to equations on page 22 of the ISL8120 data sheet ([FN6641](#)) to program the UVLO falling threshold and hysteresis. The equations are re-stated in the following, where R_{UP} and R_{DOWN} are the upper and lower resistors of the voltage divider at EN/FF pin, V_{HYS} is the desired UVLO hysteresis and V_{FTH} is the desired UVLO falling threshold.

$$R_{UP} = \frac{V_{HYS}}{I_{HYS}} \quad \text{where } I_{HYS} = 30\mu A \quad (\text{EQ. 2})$$

$$R_{DOWN} = \frac{R_{UP} \cdot V_{ENREF}}{V_{FTH} - V_{ENREF}} \quad \text{where } R_{ENREF} = 0.8V \quad (\text{EQ. 3})$$

Note the ISL8120 EN/FF pin is a triple function pin and the voltages applied to the EN/FF pins are also fed to adjust the amplitude of each channel's individual sawtooth.

DDR Application

The ISL8120 can be used as a DDR controller. The Typical Application II schematic in the ISL8120 data sheet ([FN6641](#)) shows its configuration. Channel 1 is used for VDDQ. VDDQ output is fed to the REFIN (pin) of Channel 2, thus Channel 2 can track VDDQ at start-up and supplies as VTT.

Please note the configuration of EN/FF pins for start-up timing. The VDDQ channel (Channel 1) start-up should be delayed to VTT (Channel 2) by adding more filtering at EN/FF1 than EN/FF2. This is to start-up the internal SS ramp of Channel 2 and make it invalid because EN/FF2 is still 0 coming from VDDQ (Channel 1).

Figure 2 shows the reference configurations and parameters of the EN/FF pins. RA is a resistor externally added as a filter resistor for EN/FF1.

With the configuration of Figure 2, VDDQ is 1.8V and VTT is 0.9V. The gain of the resistor divider from VDDQ (Channel 1) to REFIN (pin) should have the same value with the resistor divider of VTT (Channel 2). RB is an externally added resistor for the upper resistor of the divider from VDDQ output to REFIN.

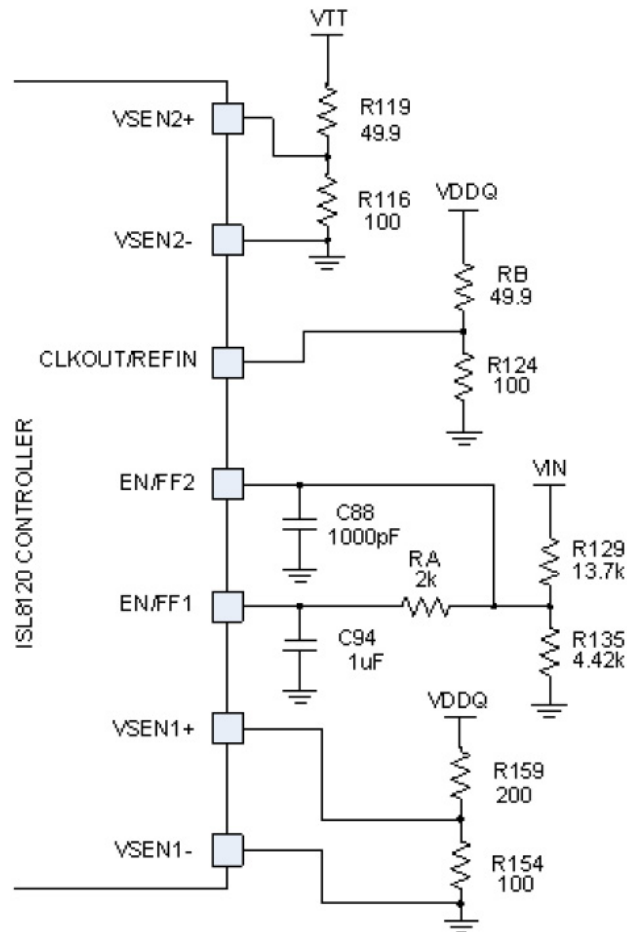
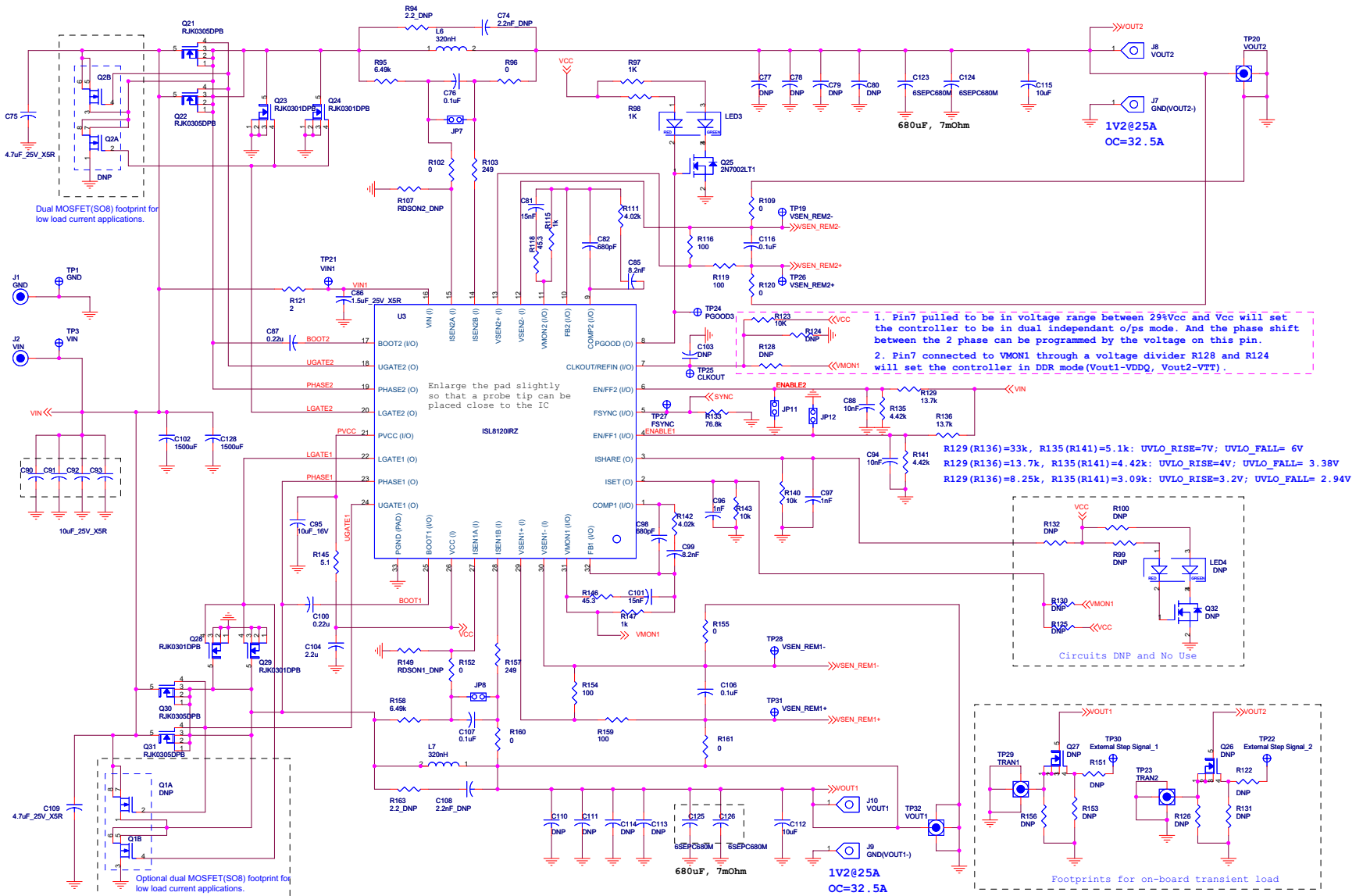

FIGURE 2. DDR CONFIGURATION

ISL8120EVAL3Z Schematic



Dual MOSFET(SO8) footprint for low load current applications.

Enlarge the pad slightly so that a probe tip can be placed close to the IC

1. Pin7 pulled to be in voltage range between 29%Vcc and Vcc will set the controller to be in dual independent o/p/s mode. And the phase shift between the 2 phase can be programmed by the voltage on this pin.
2. Pin7 connected to VMON1 through a voltage divider R128 and R124 will set the controller in DDR mode (Vout1-VDDQ, Vout2-VTT).

R129(R136)=33k, R135(R141)=5.1k: UVLO_RISE=7V; UVLO_FALL= 6V
 R129(R136)=13.7k, R135(R141)=4.42k: UVLO_RISE=4V; UVLO_FALL= 3.38V
 R129(R136)=8.25k, R135(R141)=3.09k: UVLO_RISE=3.2V; UVLO_FALL= 2.94V

Circuits DNP and No Use

Footprints for on-board transient load

Optional dual MOSFET(SO8) footprint for low load current applications.

ISL8120EVAL3Z Bill of Materials

REF DES	PART NUMBER	QTY	MANUFACTURER	DESCRIPTION
C123-C126	DNP	0		
C96, C97	GRM188R71H102KA	2	MURATA	CAP, SMD, 0603, 1000pF, 50V, 10%, X7R, ROHS
C88, C94	06032R103K8B20	2	PHILLIPS	CAP, SMD, 0603, 0.01µF, 25V, 10%, X7R, ROHS
C76, C106, C107, C116	GRM39X7R104K025AD	4	MURATA	CAP, SMD, 0603, 0.1µF, 25V, 10%, X7R, ROHS
C81, C101	ECJ-1VB1H153K	2	PANASONIC	CAP, SMD, 0603, 0.015µF, 50V, 10%, X7R, ROHS
C87, C100	C1608X7R1E224K	2	TDK	CAP, SMD, 0603, 0.22µF, 25V, 10%, X7R, ROHS
C82, C98	GMC10CG681J50NT	2	CAL-CHIP	CAP, SMD, 0603, 680pF, 50V, 5%, NPO, ROHS
C85, C99	ECJ-1VB1H822K	2	PANASONIC	CAP, SMD, 0603, 8200pF, 50V, 10%, X7R, ROHS
C74, C103, C108	DNP	0		CAP, SMD, 0603, DNP-PLACE HOLDER, ROHS
C95	C0805X5R160-106KNE	1	VENKEL	CAP, SMD, 0805, 10µF, 16V, 10%, X5R, ROHS
C86	GRM21BF51E155ZA01L	1	MURATA	CAP, SMD, 0805, 1.5µF, 25V,+80-20,Y5V, ROHS
C104	ECJ-2FB1E225K	1	PANASONIC	CAP, SMD, 0805, 2.2µF, 25V, 10%, X5R, ROHS
C112, C115	C1206X5R250-106KNE	2	VENKEL	CAP, SMD, 1206, 10µF, 25V, 10%, X5R, ROHS
C75, C109	C1206C475K3PACTU	2	KEMET	CAP, SMD, 1206, 4.7µF, 25V, 10%, X5R, ROHS
C79, C80, C113, C114	DNP	0		CAP, SMD, 1206, DNP-PLACE HOLDER, ROHS
C90, C91, C92, C93	ECJ-4YB1E106M	4	PANASONIC	CAP, SMD, 1210, 10µF, 25V, 20%, X5R, ROHS
C102, C128	25ZL1500M12.5X25	2	RUBYCON	CAP, RADIAL, 12.5X25, 1500µF, 25V, 20%, ALUM.ELEC., ROHS
C77, C78, C110, C111	2R5TPF470M7L	4	SANYO	CAP, POSCAP, SMD, 7.3X4.3, 470µF, 2.5V, 20%, 7mΩ, ROHS
L6, L7	PA1513.321NLT	2	PULSE	COIL-PWR INDUCTOR, SMD, 13mm, 320nH, 20%, 45A, Pb-Free
J2	111-0702-001	1	JOHNSON COMPONENTS	CONN-GEN, BIND.POST, INSUL-RED, THMBNUT-GND
J1	111-0703-001	1	JOHNSON COMPONENTS	CONN-GEN,BIND.POST,INSUL-BLK, THMBNUT-GND
TP20, TP32	131-4353-00	2	TEKTRONIX	CONN-SCOPE PROBE TEST PT, COMPACT, PCB MNT, ROHS
TP1, TP3, TP19, TP21, TP22, TP24, TP25, TP26, TP27, TP28, TP30, TP31	5002	12	KEystone	CONN-MINI TEST POINT, VERTICAL, WHITE, ROHS
JP7, JP8, JP11, JP12	69190-202	4	BERG/FCI	CONN-HEADER, 1x2, RETENTIVE, 2.54mm, ST, ROHS
LED4	DNP	0		
LED3	SSL-LXA3025IGC-TR	1	LUMEX	LED, SMD, 3mmx2.5mm, 4P, RED/GREEN, 12/20MCD, 2V
U3	ISL8120IRZ	1	INTERSIL	IC-DUAL PHASE PWM CONTROLLER, 32P, QFN, 5X5, ROHS
Q25	2N7002-7-F	1	DIODES, INC.	TRANSISTOR,N-CHANNEL, 3LD, SOT-23, 60V, 115mA, ROHS
Q1, Q2	DNP	0		DNP-PLACE HOLDER,TRANSIST-DUAL MOS, N-CHAN, 8P, SOIC, 30V, 6A, ROHS
Q26, Q27	DNP	0		DNP-PLACE HOLDER, TRANSIST-MOSFET, N-CHAN, 5P, LPAK, 30V, 9.4mΩ,ROHS

Application Note 1528

ISL8120EVAL3Z Bill of Materials (Continued)

REF DES	PART NUMBER	QTY	MANUFACTURER	DESCRIPTION
Q32	DNP	0		DNP-PLACE HOLDER
Q23, Q24, Q28, Q29	RJK0301DPB	4	RENESAS TECHNOLOGY	TRANSISTOR,N-CHANNEL, 5P, LFPK, 30V, 60A, ROHS
Q21, Q22, Q30, Q31	RJK0305DPB	4	RENESAS TECHNOLOGY	TRANSISTOR,N-CHANNEL, 5P, LFPK, 30V, 30A, ROHS
R145	CRCW06035R10FNEA	1	VISHAY/DALE	RES,SMD,0603, 5.1Ω,1/10W,1%,TF,ROHS
R96, R102, R109, R120, R152, R155, R160, R161		8	Various	RESISTOR, SMD, 0603, 0Ω, 1/10W, TF, ROHS
R116, R119, R154, R159	RK73H1JT1000F	4	KOA	RES, SMD, 0603, 100Ω, 1/10W, 1%, TF, ROHS
R97, R98, R115, R147	RK73H1JT1001F	4	KOA	RES, SMD, 0603, 1k, 1/10W, 1%, TF, ROHS
R123, R140, R143	RK73H1JT1002F	3	KOA	RES, SMD, 0603, 10k, 1/10W, 1%, TF, ROHS
R129, R136	RC0603FR-0713K7L	2	YAGEO	RESISTOR, SMD, 0603, 13.7k, 1/10W, 1%, TF, ROHS
R103, R157	CR0603-10W-2490FT	2	VENKEL	RES, SMD, 0603, 249Ω, 1/10W, 1%, TF, ROHS
R111, R142	ERJ-3EKF4021V	2	PANASONIC	RES, SMD, 0603,4.02kΩ, 1/10W, 1%, TF, ROHS
R135, R141	RC0603FR-074K42L	2	YAGEO	RES, SMD, 0603, 4.42k, 1/10W, 1%, TF, ROHS
R118, R146	CR0603-10W-45R3FT	2	VENKEL	RES, SMD, 0603, 45.3Ω, 1/10W, 1%, TF, ROHS
R95, R158	ERJ-3EKF6491V	2	PANASONIC	RES, SMD, 0603, 6.49k, 1/10W, 1%, TF, ROHS
R133	CR0603-10W-7682FT	1	VENKEL	RES, SMD, 0603, 76.8k, 1/10W, 1%, TF, ROHS
R99, R100, R107, R122, R124, R125, R128, R130-R132, R149, R151, R153.	DNP	0		RES, SMD, 0603, DNP-PLACE HOLDER, ROHS
R94, R163	DNP	0		RES, SMD, 0805, DNP-PLACE HOLDER, ROHS
R121	CR1206-4W-02R0	1	VENKEL	RES, SMD, 1206, 2Ω, 1/4W, 1%, TF, ROHS
R126, R156	DNP	0		RES, SMD, 2512, PLACE HOLDER, TF, ROHS
J7, J8, J9, J10	KPA8CTP	4	BERG/FCI	HDWARE, MTG, CABLE TERMINAL, 6-14AWG, LUG&SCREW, ROHS
TP23, TP29,	DNP	0		DNP-PLACE HOLDER

ISL8120EVAL3Z Board Layout

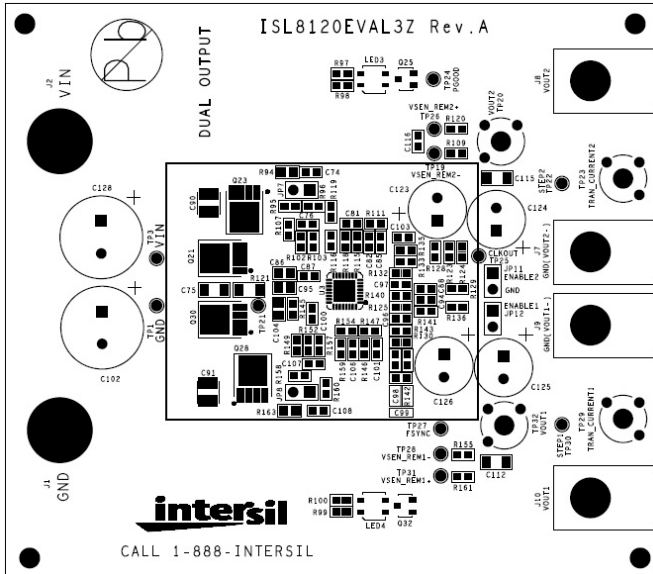

FIGURE 3. TOP SILKSCREEN

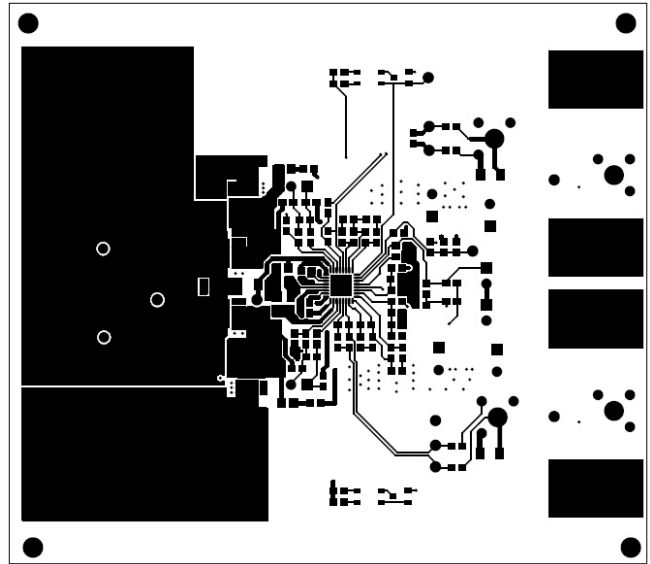

FIGURE 4. TOP LAYER

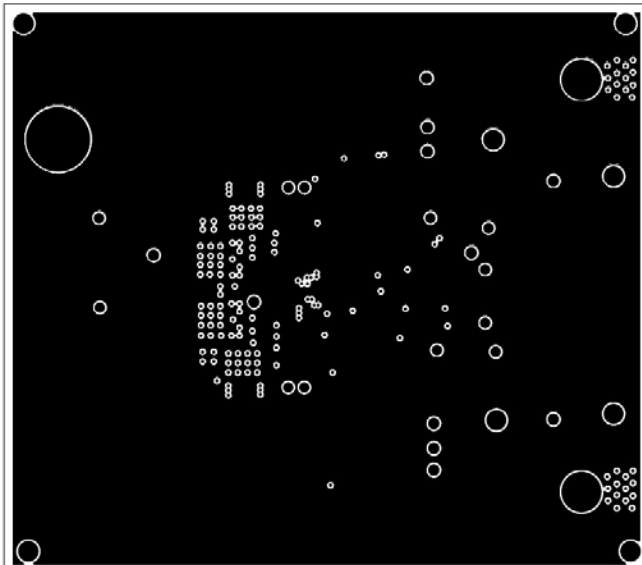

FIGURE 5. 2nd LAYER

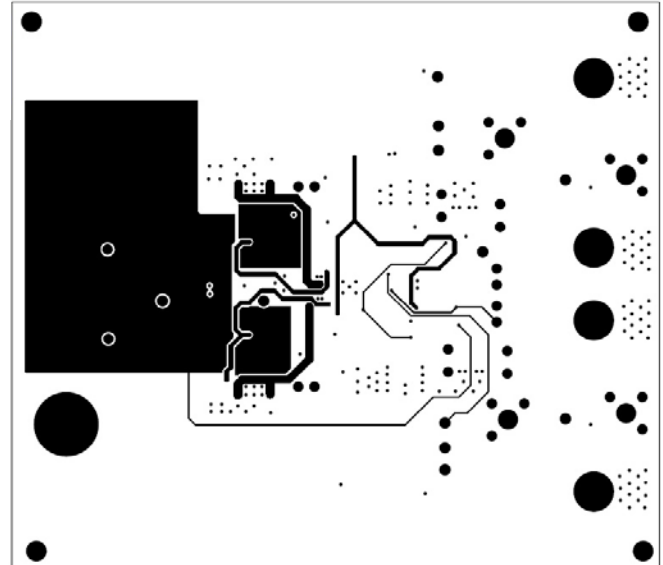

FIGURE 6. 3rd LAYER

ISL8120EVAL3Z Board Layout (Continued)

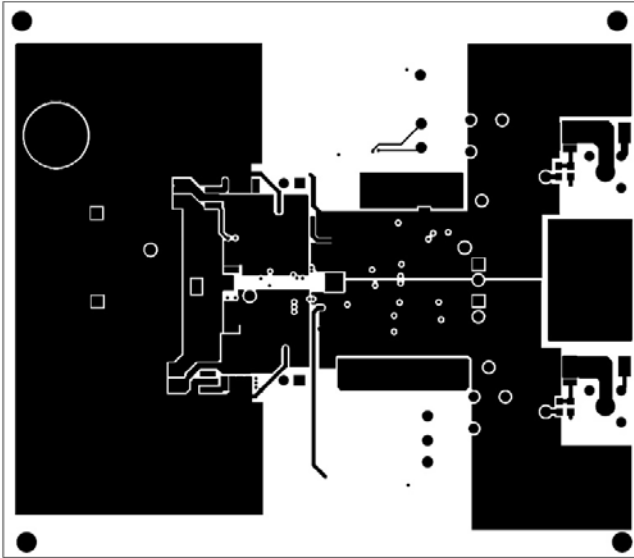

FIGURE 7. BOTTOM LAYER

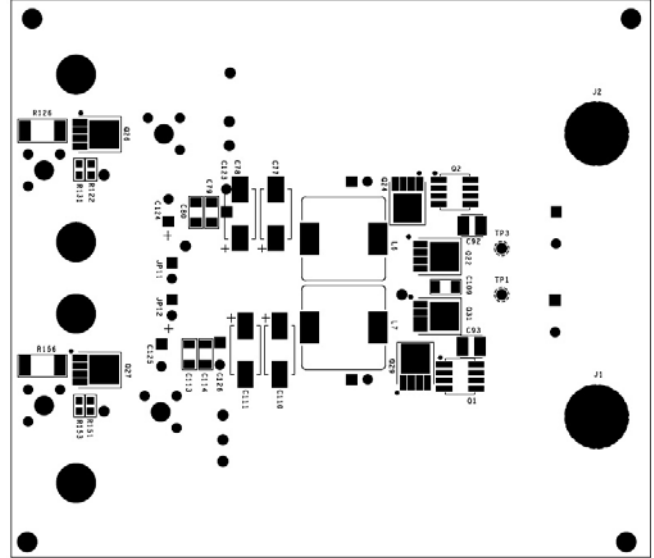

FIGURE 8. BOTTOM SILKSCREEN (MIRRORED)

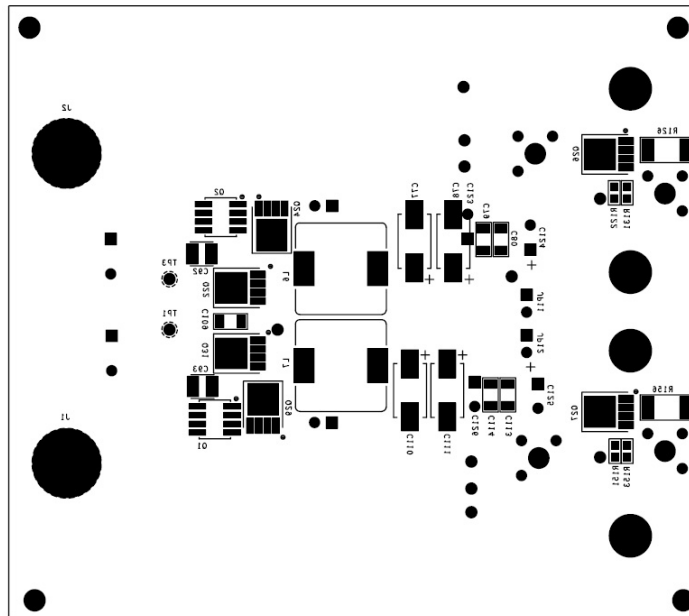

FIGURE 9. BOTTOM SILKSCREEN

Test Data for ISL8120EVAL3Z

Efficiency

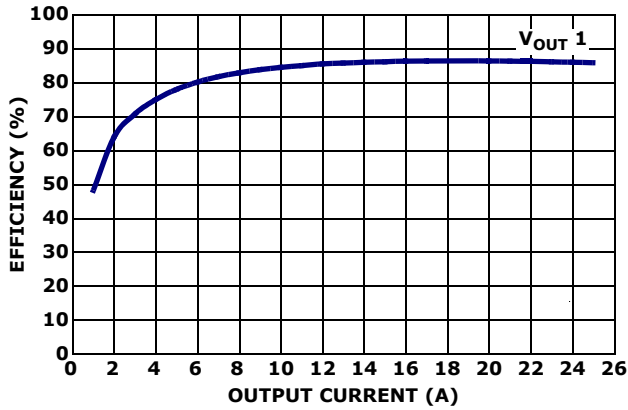

FIGURE 10. CHANNEL 1 EFFICIENCY (12V V_{IN} AND 1.2V V_{OUT})

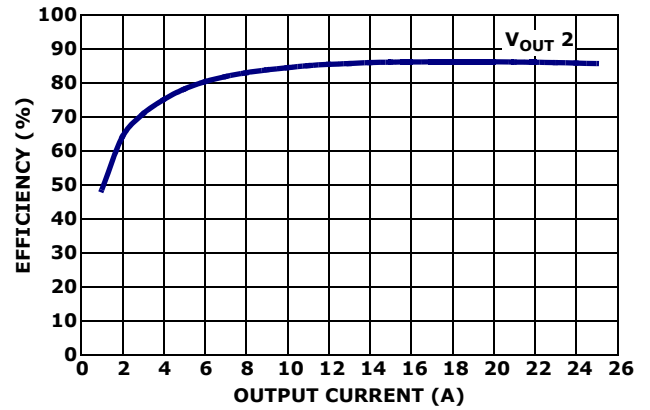

FIGURE 11. CHANNEL 2 EFFICIENCY (12V V_{IN} AND 1.2V V_{OUT})

Line Regulation

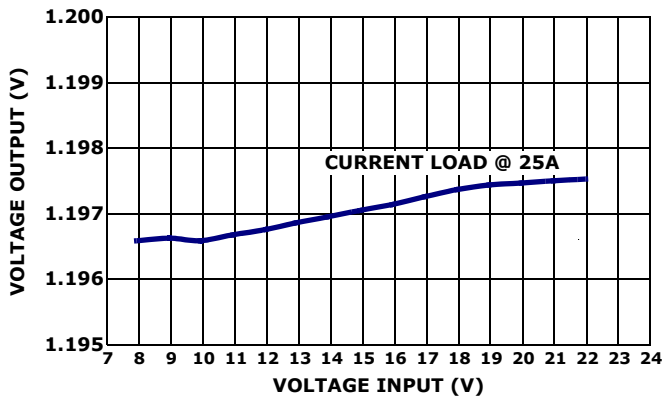

FIGURE 12. CHANNEL 1 LINE REGULATION

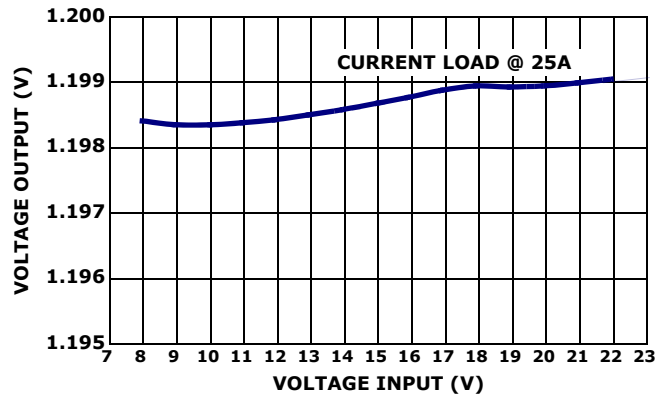

FIGURE 13. CHANNEL 1 LINE REGULATION

Start-up

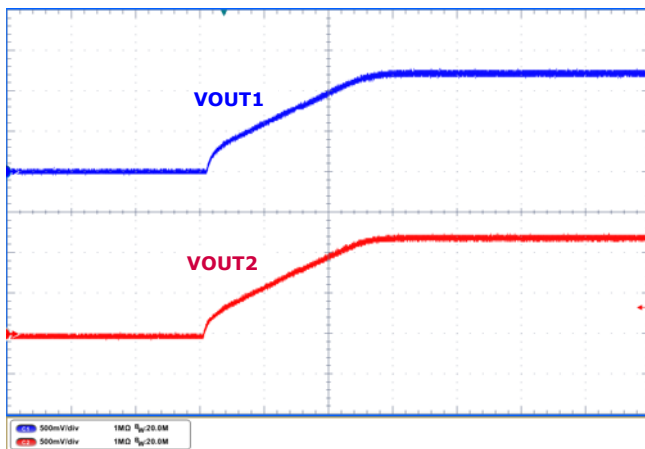

FIGURE 14. POWER-UP UNDER FULL LOAD (25A FOR EACH CHANNEL)

Load Transient

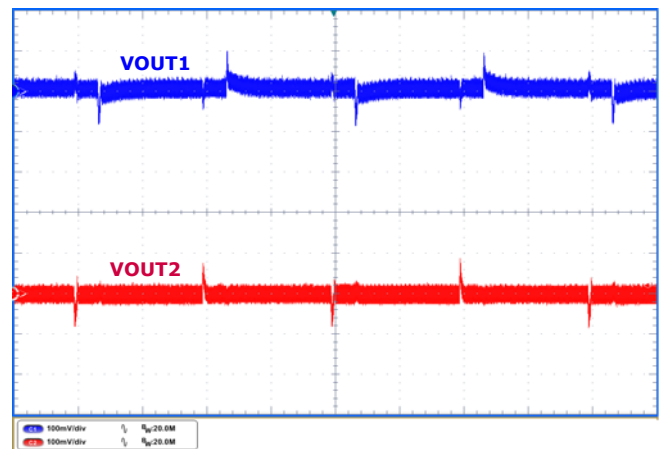

FIGURE 15. LOAD TRANSIENT (0A TO 25A STEP, SLEW_RATE = 1.6A/ μ s)

Test Data for ISL8120EVAL3Z (Continued)

Output Ripple

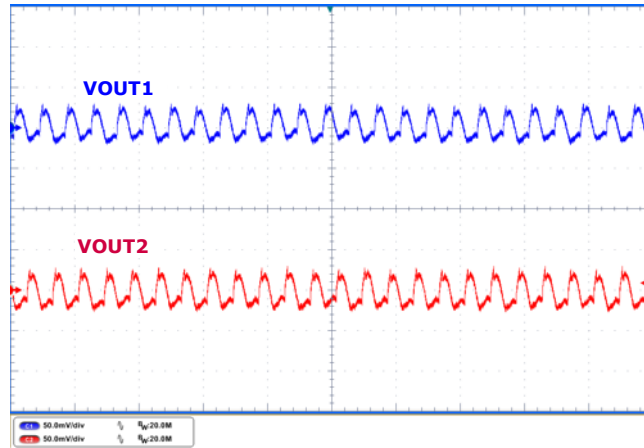

FIGURE 16. OUTPUTS RIPPLE UNDER 25A LOAD FOR EACH CHANNEL

DDR Application Waveforms

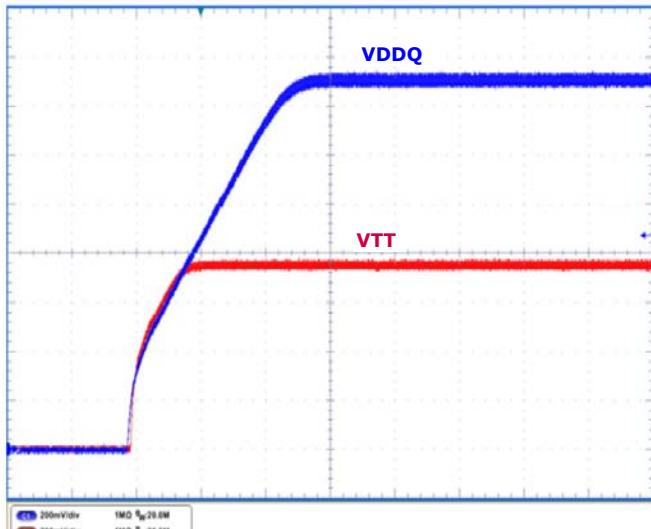

FIGURE 17. VDDQ AND VTT START-UP TRACKING (DDR3)

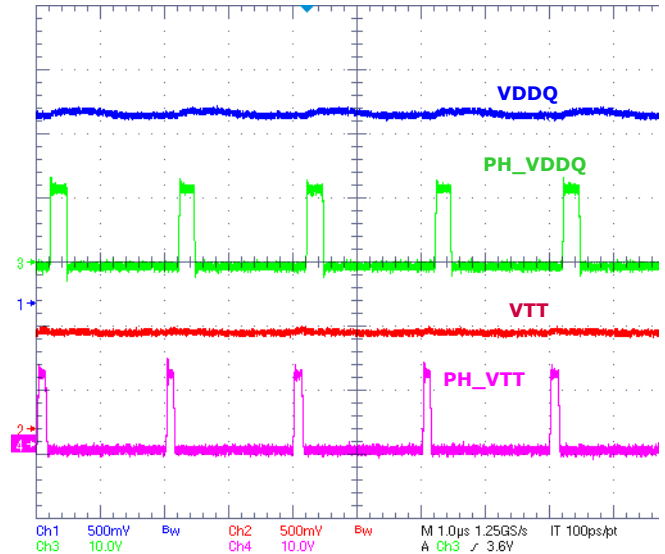

FIGURE 18. PHASE AND VOUTS (DDR3)

Intersil Corporation reserves the right to make changes in circuit design, software and/or specifications at any time without notice. Accordingly, the reader is cautioned to verify that the Application Note or Technical Brief is current before proceeding.

For information regarding Intersil Corporation and its products, see www.intersil.com