

SL869 Product Description

80405ST10105A r6 - 2014-09-15



APPLICABILITY TABLE

PRODUCT
SL869



SPECIFICATIONS SUBJECT TO CHANGE WITHOUT NOTICE

Notice

While reasonable efforts have been made to assure the accuracy of this document, Telit assumes no liability resulting from any inaccuracies or omissions in this document, or from use of the information obtained herein. The information in this document has been carefully checked and is believed to be entirely reliable. However, no responsibility is assumed for inaccuracies or omissions. Telit reserves the right to make changes to any products described herein and reserves the right to revise this document and to make changes from time to time in content hereof with no obligation to notify any person of revisions or changes. Telit does not assume any liability arising out of the application or use of any product, software, or circuit described herein; neither does it convey license under its patent rights or the rights of others.

It is possible that this publication may contain references to, or information about Telit products (machines and programs), programming, or services that are not announced in your country. Such references or information must not be construed to mean that Telit intends to announce such Telit products, programming, or services in your country.

Copyrights

This instruction manual and the Telit products described in this instruction manual may be, include or describe copyrighted Telit material, such as computer programs stored in semiconductor memories or other media. Laws in the Italy and other countries preserve for Telit and its licensors certain exclusive rights for copyrighted material, including the exclusive right to copy, reproduce in any form, distribute and make derivative works of the copyrighted material. Accordingly, any copyrighted material of Telit and its licensors contained herein or in the Telit products described in this instruction manual may not be copied, reproduced, distributed, merged or modified in any manner without the express written permission of Telit. Furthermore, the purchase of Telit products shall not be deemed to grant either directly or by implication, estoppel, or otherwise, any license under the copyrights, patents or patent applications of Telit, as arises by operation of law in the sale of a product.

Computer Software Copyrights

The Telit and 3rd Party supplied Software (SW) products described in this instruction manual may include copyrighted Telit and other 3rd Party supplied computer programs stored in semiconductor memories or other media. Laws in the Italy and other countries preserve for Telit and other 3rd Party supplied SW certain exclusive rights for copyrighted computer programs, including the exclusive right to copy or reproduce in any form the copyrighted computer program. Accordingly, any copyrighted Telit or other 3rd Party supplied SW computer programs contained in the Telit products described in this instruction manual may not be copied (reverse engineered) or reproduced in any manner without the express written permission of Telit or the 3rd Party SW supplier. Furthermore, the purchase of Telit products shall not be deemed to grant either directly or by implication, estoppel, or otherwise, any license under the copyrights, patents or patent applications of Telit or other 3rd Party supplied SW, except for the normal non-exclusive, royalty free license to use that arises by operation of law in the sale of a product.



Usage and Disclosure Restrictions

License Agreements

The software described in this document is the property of Telit and its licensors. It is furnished by express license agreement only and may be used only in accordance with the terms of such an agreement.

Copyrighted Materials

Software and documentation are copyrighted materials. Making unauthorized copies is prohibited by law. No part of the software or documentation may be reproduced, transmitted, transcribed, stored in a retrieval system, or translated into any language or computer language, in any form or by any means, without prior written permission of Telit

High Risk Materials

Components, units, or third-party products used in the product described herein are NOT fault-tolerant and are NOT designed, manufactured, or intended for use as on-line control equipment in the following hazardous environments requiring fail-safe controls: the operation of Nuclear Facilities, Aircraft Navigation or Aircraft Communication Systems, Air Traffic Control, Life Support, or Weapons Systems (High Risk Activities"). Telit and its supplier(s) specifically disclaim any expressed or implied warranty of fitness for such High Risk Activities.

Trademarks

TELIT and the Stylized T Logo are registered in Trademark Office. All other product or service names are the property of their respective owners.

Copyright © Telit Communications S.p.A. 2012, 2013.



Contents

1. Introduction	8
1.1. Scope	8
1.2. Audience.....	8
1.3. Contact Information, Support.....	8
1.4. Document Organization	9
1.5. Text Conventions	9
1.6. Related Documents	10
2. Overview.....	11
3. Technical Description.....	12
3.1. Receiver Architecture.....	13
3.2. Major Components	13
3.2.1. GNSS Chip.....	13
3.2.2. RF_IN	13
3.2.3. VCC	14
3.2.4. VBATT	14
3.2.5. Serial Interface	14
3.2.6. SAW Filter	14
3.2.7. TCXO.....	14
3.2.8. RTC.....	14
3.2.9. Memory.....	14
3.3. Physical Characteristics.....	14
3.4. Mechanical Specification	15
3.5. External Antenna Connection	15
3.6. Input/Output and Power Connections	15
3.7. Environmental	15
3.8. Compliances	15
3.9. Marking/Serialization.....	16
4. Performance Characteristics.....	17
4.1. TTF (Time to First Fix).....	17
4.1.1. Hot Start.....	17
4.1.2. Warm Start	17
4.1.3. Cold Start	17



4.2.	AGPS.....	17
4.2.1.	Local AGPS	17
4.2.2.	Server-Based AGPS	18
4.3.	Time Mark Pulse (1PPS).....	18
4.4.	Differential Aiding	18
4.4.1.	Satellite Based Augmentation Systems (SBAS)	18
4.4.2.	RTCM	18
4.5.	Reduced Power Modes	19
4.5.1.	Adaptive Channel Management	19
4.5.2.	Duty Cycling	19
4.6.	Timing	19
4.7.	Dead Reckoning (DR).....	20
4.8.	Performance Data	21
4.9.	SL869-T Timing Performance Data.....	21
4.10.	Dynamic Constraints	22
5.	Electrical Requirements.....	23
5.1.	Power Supply	23
5.1.1.	VCC	23
5.1.2.	VBATT	23
5.2.	External Antenna Voltage	23
5.3.	RF (Radio Frequency) Input	23
5.4.	Antenna Gain.....	23
5.5.	Burnout Protection	23
5.6.	Jamming Performance	24
5.7.	Flash Upgradability	24
5.8.	Data Input/Output Specifications	24
5.8.1.	Voltages and Currents	25
5.8.2.	DC Electrical Characteristics	26
5.8.3.	Pinout Description.....	27
6.	Software Interface	28
6.1.	NMEA Output Messages	28
6.1.1.	Standard Messages.....	28
6.1.2.	Proprietary Messages	28
6.2.	NMEA Commands.....	28



- 7. Mechanical Drawing29**
- 8. Evaluation Kit.....32**
- 9. Product Compatibility.....33**
- 10. Product Handling.....34**
 - 10.1. Product Packaging and Delivery34
 - 10.2. Moisture Sensitivity.....36
 - 10.3. ESD Sensitivity.....36
 - 10.4. Safety.....36
 - 10.5. Disposal36
- 11. Conformity Assessment.....37**
 - 11.1. CE Conformity Declaration.....37
 - 11.2. R&TTE Notified Body Opinion38
 - 11.3. RoHS Declaration.....39
- 12. Glossary and Acronyms40**
- 13. Safety Recommendations42**
- 14. Document History43**



1. Introduction

1.1. Scope

Scope of this document is to give an overview of SL869 GNSS family of modules.

- SL869 is a standalone GNSS module
- SL869-T is a GNSS Timing module that also supports TRAIM
- SL869-DR is a GNSS Dead Reckoning module that supports MEMS Gyro plus Wheel Ticks or CAN Bus configurations

1.2. Audience

This document is intended for customers developing applications using SL869.

1.3. Contact Information, Support

For general contact, technical support, to report documentation errors and to order manuals, contact Telit Technical Support Center (TTSC) at:

TS-EMEA@telit.com
TS-NORTHAMERICA@telit.com
TS-LATINAMERICA@telit.com
TS-APAC@telit.com

Alternatively, use:

<http://www.telit.com/en/products/technical-support-center/contact.php>

For detailed information about where you can buy the Telit modules or for recommendations on accessories and components visit:

<http://www.telit.com>

To register for product news and announcements or for product questions contact Telit Technical Support Center (TTSC).

Our aim is to make this guide as helpful as possible. Keep us informed of your comments and suggestions for improvements.

Telit appreciates feedback from the users of our information.



1.4. Document Organization

This document contains the following chapters:

[“Chapter 1: “Introduction”](#) provides a scope for this document, target audience, contact and support information, and text conventions.

[“Chapter 2: “Overview”](#) gives an overview of the features of the product.

[“Chapter 3: “Technical Description”](#) describes the features of the product.

[“Chapter 4: “Performance Characteristics”](#) describes in details the characteristics of the product.

[“Chapter 5: “Electrical Requirements”](#) describes in details the electrical characteristics of the product.

[“Chapter 6: “Software Interface”](#) provides information on default serial configuration.

[“Chapter 7: “Mechanical Drawings”](#) provides info about Hardware interfaces.

[“Chapter 8: “Evaluation Kit”](#) provides some fundamental hints about evaluation Kit.

[“Chapter 9: “Product Compatibility”](#) describes the compatibility between SL869 and JN3.

[“Chapter 10: “Product Handling”](#) describes the packaging and mounting of the module

[“Chapter 11: “Conformity”](#) shows a Declaration of Conformity and CETECOM ICT Certificate,

[“Chapter 12: “ROHS Declaration”](#) states that the Telit SL869 module is fully compliant to EU Directives.

[“Chapter 13 “Glossary and Acronyms”](#) contain the explanation of acronyms used in the present document

[“Chapter 14: “Safety Recommendation”](#) provides some safety recommendations that must be follow by the customer in the design of the application that makes use of the SL869.

[“Chapter 15: “Document History”](#) provides the history of the present document.

1.5. Text Conventions



Danger - This information MUST be followed or catastrophic equipment failure or bodily injury may occur.



Caution or Warning - Alerts the user to important points about integrating the module, if these points are not followed, the module and end user equipment may fail or malfunction.



Tip or Information - Provides advice and suggestions that may be useful when integrating the module.

All dates are in ISO 8601 format, i.e. YYYY-MM-DD.



1.6. Related Documents

- SL869 Hardware User Guide, 1VV0301001
- SL869 Software User Guide, 1VV0301002
- SL869 EVK User Guide, 1VV0301004
- SL869 Timing Software User Guide, 1VV0301094
- SL869 DR Hardware User Guide, 1VV0301xx
- SL869 DR EVK User Guide, 1VV0301098



2. Overview

The SL869 represents a new age of receiver that can simultaneously search and track satellite signals from multiple satellite constellations. This multi-GNSS receiver uses the entire spectrum of GNSS systems available: GPS, GLONASS, Galileo and QZSS.

Operation in a high interference signal environment is common practice in today's electronic age. By incorporating 3-stage rejection architecture, the SL869 is able to remove interfering signals pre- and post-correlation.

Operating on a single 3.3V power supply, this module combines a GNSS engine, TCXO, SAW Filter, RTC and LDO. Communication is done over a UART serial port using NMEA message format.

The SL869 shares the same form factor as the Telit Jupiter JN3 and SL869 V2 families, 16mm x 12.2mm, commonly used in the industry.

The SL869 product family; SL869, SL869-T and SL986-DR offers default configurations to meet specific market needs.

As a the **Standard GNSS Module**, the **SL869** offering high sensitivity, low power consumption, jamming immunity and fast time to first fix.

As a **Timing Module**, the **SL869-T** provides best-in-class timing performance with an extremely stable synchronized 1PPS output and TRAIM (Time-Receiver Autonomous Integrity Monitor) integrity monitoring.

As a **DR Module**, the **SL869-DR** receiver provides the user with accurate estimates of vehicle's position and velocity when GNSS information is lost or not available by combining speed and heading sensor data into the solution. The result is improved navigation in harsh urban canyon environments.



3. Technical Description

High-speed Location Engine – An ARM9 core with embedded Flash memory offers enhanced sensitivity, fast time to first fix and improved position accuracy.

Battery Backup is supported via a separate pin for applications that use a battery backup source.

Jammer Immunity – Three stage jamming rejection approaches, actively identify and remove jammers pre- and post-correlation. This feature maximizes GPS performance.

High Performance Solution:

- High sensitivity navigation engine (PVT) tracks as low as -161dBm
- 32 track verification channels
- SBAS: WAAS, EGNOS, and MSAS



3.1. Receiver Architecture

The functional architecture of the SL869 receiver is shown in Figure 1.

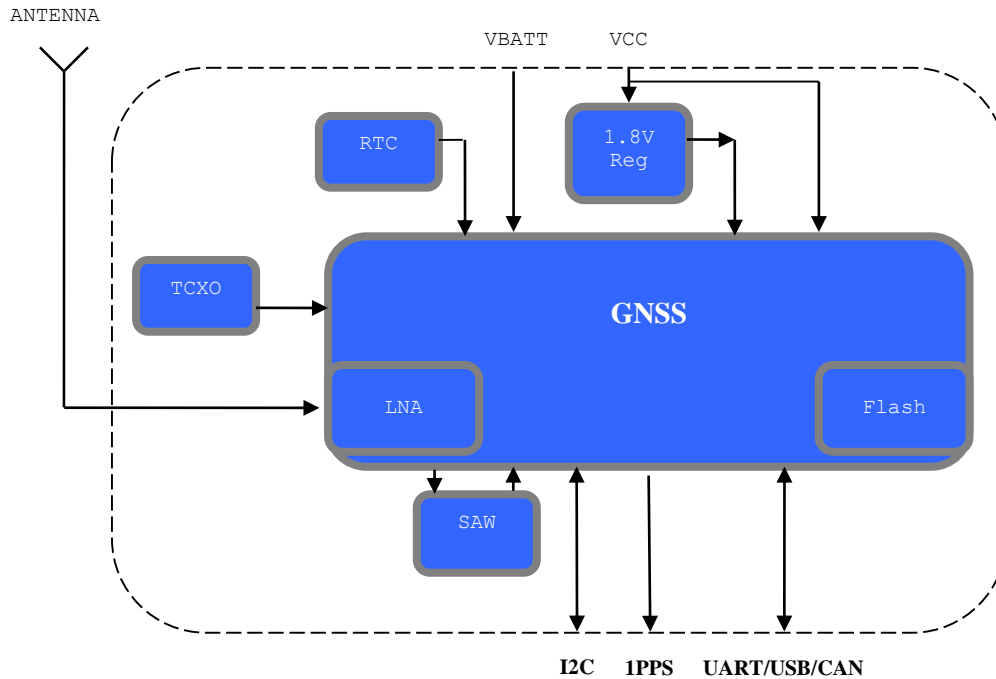

Figure 1 SL869 Architecture

Note: LNA is included in the GNSS chip for passive antenna operation.

3.2. Major Components

All power supply components are on board including capacitors.

3.2.1. GNSS Chip

This single chip GNSS device includes an integrated Baseband and RF section. The LNA amplifies the GPS signal and provides enough gain for the receiver to use a passive antenna. A very low noise design is utilized to provide maximum sensitivity. Flash memory is integrated so external memory is not required.

3.2.2. RF_IN

This GNSS RF signal input supports both active and passive antennas. An external BIAS-T and antenna voltage supply are required for an active antenna.



3.2.3. VCC

This is the primary 3.0V to 3.6V supply voltage for the module. The SL869 includes a switching voltage regulator that supplies 1.8V to the GNSS device.

3.2.4. VBATT

The Battery Backup supply voltage is 2.5V to 3.6V. It is a typical low current supply for ensuring that the RTC is kept running and critical data is maintained to enable HOT/WARM starts.

3.2.5. Serial Interface

The SL869 host serial port is the primary communications port which outputs data and accepts commands in NMEA format.

- Main Serial Interface: Standard asynchronous RX/TX 8-bit protocol on pins 20 & 21.
- Secondary Serial Interface: Normally not used, but can be utilized for RTCM differential corrections into the receiver. If debug is enabled, the debug data is output on this port.
- Tertiary Serial Interface: Hardware controlled through USB_DETECT on pin 7. This port is only used as a USB Port. See the HW User Guide for more details.

3.2.6. SAW Filter

This filters the GNSS signal and removes unwanted signals caused by external influences that would corrupt the operation of the receiver. The integrated LNA outputs to the SAW filter which then feeds the GNSS receiver.

3.2.7. TCXO

This highly stable 26 MHz oscillator controls the down conversion process for the RF block.

3.2.8. RTC

The 32 KHz Real Time Clock allows Hot/Warm starts.

3.2.9. Memory

The SL869 has an integrated 2Mbyte Flash device for operational software and satellite data storage.

3.3. Physical Characteristics

The SL869 receiver has advanced miniature packaging with a base metal of copper and an Electro less Nickel Immersion Gold (ENIG) finish.

It has a tin-plated shield and 24 interface pads. These pads are castellated edge contacts.



3.4. Mechanical Specification

The physical dimensions of the SL869 are as follows:

- length: 16.0 mm \pm 0.1 mm
- width: 12.2 mm \pm 0.1 mm
- thickness: 2.55 mm \pm 0.22 mm
- weight: 1 g max

Refer to Figure 2 for the SL869 mechanical layout drawing.

3.5. External Antenna Connection

The RF connection for the external antenna has a characteristic impedance of 50 ohms.

3.6. Input/Output and Power Connections

The I/O (Input / Output) and power connections use surface mount pads.

3.7. Environmental

The environmental operating conditions of the SL869 are as follows:

- temperature: -40°C to $+85^{\circ}\text{C}$ (measured on the shield)
- humidity: up to 95% non-condensing or a wet bulb temperature of $+35^{\circ}\text{C}$

3.8. Compliances

The SL869 complies with the following:

- Directive 2002/95/EC on the restriction of the use of certain hazardous substances in electrical and electronic equipment (RoHS)
- Manufactured in an ISO 9000: 2000 accredited facility
- Manufactured to TS 16949 requirement (upon request)

Moreover, the SL869 module is conform to the following European Union Directives:

- Low Voltage Directive 2006/95/EEC and product safety
- Directive EMC 2004/108/EC for conformity for EMC



3.9. Marking/Serialization

The SL869 supports a 2D barcode indicating the unit serial number below. The Telit 13-character serial number convention is:

- characters 1 and 2: year of manufacture (e.g. 13 = 2013, 14 = 2014)
- characters 3 and 4: week of manufacture (01 to 52, starting first week in January)
- character 5: manufacturer code
- characters 6 and 7: product and type
- character 8: product revision
- characters 9-13: sequential serial number



4. Performance Characteristics

4.1. TTFF (Time to First Fix)

TTFF is the actual time required by a GPS receiver to achieve a valid position solution. This specification will vary with the operating state of the receiver, the length of time since the last position fix, the location of the last fix, and the specific receiver design.

Please refer to section 4.8 for performance data.

4.1.1. Hot Start

A hot start results from a software reset after a period of continuous navigation, or a return from a short idle period (i.e. a few minutes) that was preceded by a period of continuous navigation. In this state, all of the critical data (position, velocity, time, and satellite ephemeris) is valid to the specified accuracy and available in memory.

4.1.2. Warm Start

A warm start typically results after a period of continuous navigation is followed by an extended period of continuous RTC operation with an accurate last known position available in memory. In this state, position and time data are present and valid but ephemeris data validity has expired.

4.1.3. Cold Start

A cold start acquisition results when either position or time data is unknown. Almanac information is used to identify previously healthy satellites.

4.2. AGPS

GPS aiding, also known as Assisted GPS (AGPS), is a method by which TTFF is reduced using information from a source other than broadcast GPS signals. The form of assisted GPS data supported and used by the module is predicted ephemeris data.

Ephemeris predictions is a method of GPS aiding that effectively reduces the TTFF through the use of predicted ephemeris data as a substitute for broadcast ephemeris data to produce a navigation solution. In this way, every start is potentially a hot start.

There are two sources of predicted ephemeris – locally predicted ephemeris and server-based predicted ephemeris data.

4.2.1. Local AGPS

Proprietary algorithms within the module perform ephemeris prediction locally from captured broadcast ephemeris data from tracked satellites. The algorithms predict ephemeris for up to five days.



4.2.2. Server-Based AGPS

Server-based ephemeris predictions are generated by a third party and are maintained on Telit AGPS servers in a file. The predicted ephemeris file is obtained from the AGPS server and is injected into the module over the Host port. These predictions do not require local broadcast ephemeris collection, and they are valid for up to seven days.

The module supports server-based AGPS as standard. Contact TELIT for support regarding this service.

4.3. Time Mark Pulse (1PPS)

For standard SL869 modules, a 1PPS time mark is output whenever the receiver has a navigation fix of 2D fix or better. For SL869-T timing modules, the 1PPS time mark pulse is output all the time. The 1PPS output at a 50% duty cycle, has a default pulse width of 500ms.

4.4. Differential Aiding

The module supports differential GPS (DGPS) operation. DGPS improves position accuracy by correcting GPS signal errors caused by ionospheric disturbances as well as timing and satellite orbit errors.

4.4.1. Satellite Based Augmentation Systems (SBAS)

The SL869 is capable of receiving WAAS, EGNOS, and MSAS satellite differential corrections, which are regional implementations of SBAS for North America, Europe, and Eastern Asia, respectively.

4.4.2. RTCM

The SL869 accepts RTCM SC-104 standard differential corrections data, which are typically received by an RTCM radio beacon receiver. RTCM corrections are accepted over a serial port. The module supports message types 1 and 9.



4.5. Reduced Power Modes

The SL869 supports operational modes in that allow it to provide positioning information at reduced overall current consumption.

4.5.1. Adaptive Channel Management

The SL869 supports an adaptive channel management algorithm which dynamically switches off a GNSS constellation and reduces the number of tracked satellites when conditions allow.

4.5.2. Duty Cycling

The SL869 supports power cycling of the RF chain such that satellites are tracked for shorter periods of time between positioning updates.

4.6. Timing

The SL869-T (Timing Module) provides an independent and highly accurate 1PPS output, synchronized to GNSS time or UTC within <20 nanoseconds (average over 24 hr. period) and a Timing Receiver Autonomous Integrity Monitoring (TRAIM) algorithm for maintaining PPS integrity. In addition, the 1PPS output remains accurate with only one satellite in track.

- Self-Survey Mode – The accuracy and integrity of a timing solution is highly dependent on the accuracy of the reference position. Automatic self-survey mode offers a commanded reference position determination, cable delay compensation and the ability to remove delays between antenna and module.
- Cable Delay Compensation – The ability to compensate for RF cable loss is critical in GNSS receivers used in accurate timing applications. The SL869 has the ability to advance or delay the 1PPS signal to compensate for any delay in the RF path into the receiver.
- TRAIM – Timing Receiver Autonomous Integrity Monitoring is the ability of a GNSS receiver to identify, isolate and remove from the solution any satellite that is experiencing Time-Of-Week (TOW) transmission errors.



4.7. Dead Reckoning (DR)

When GPS signals are blocked (e.g. tunnels or parking structures) the SL869-DR (Dead Reckoning) Module allows uninterrupted vehicle navigation based on heading and distance data provided by external sensors.

The SL869-DR supports sensor or message based capability. The table below provides a list of sensor-based DR configurations supported. In addition, an accelerometer (optional) can be used for automatic tilt compensation for ease of installation.

Note: The CAN configurations can utilize a built-in CAN Bus translator to reduce overall BOM cost.

DR Configuration	Yaw Rate Sensor	Distance Sensor	Other Sensors
Classic	MEMS Gyro (1 or 3 axis)	Discrete Odometer	Discrete Reverse Signal
CAN Gyro	CAN Gyro	CAN Odometer	CAN Reverse Signal
Differential Wheel Pulse (DWP)	CAN DWP (ABS)	CAN Odometer	CAN Reverse Signal
Mixed	MEMS Gyro (1 or 3 axis)	CAN Odometer	CAN Reverse Signal

Table 1: DR Configuration Options

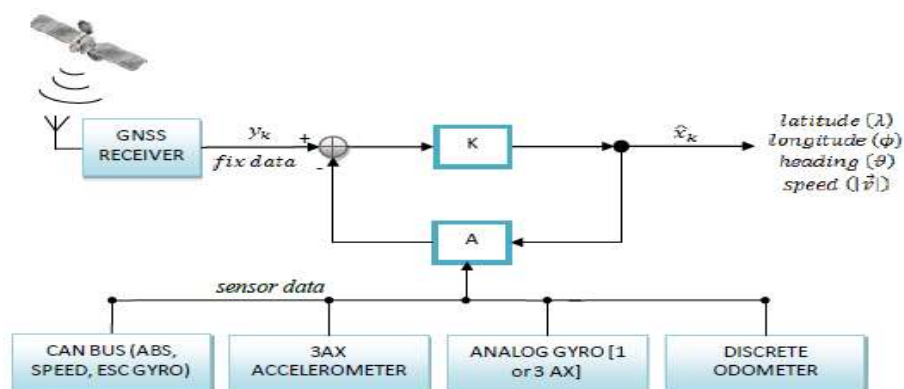

Figure 2: DR Sensor Interface

4.8. Performance Data

Parameter	Description	Performance			
		Min	Typical	Max	Units
Horizontal Position Accuracy ¹	Autonomous	-	<1.5	-	m
GPS Only Time to First Fix ²	Hot Start	-	<1	-	s
	Warm Start	-	<35	-	s
	Cold Start	-	<35	-	s
GPS + GLO Time to First Fix	Hot Start	-	<1.75	-	s
	Warm Start	-	<32	-	s
	Cold Start	-	<32	-	s
GPS Only Sensitivity ³	Acquisition	-146	-	-	dBm
	Tracking	-162	-	-	dBm
	Navigation	-158	-	-	dBm
GPS + GLO Sensitivity ³	Acquisition	-146	-	-	dBm
	Tracking	-158	-	-	dBm
	Navigation	-156	-	-	dBm
¹ 50%, 24 hr. static, -130 dBm, Full Power					
² Minimum 500 trials, -130 dBm					
³ In-line LNA used with 1dB noise figure (NF) and 20dB gain.					

Table 2 – SL869 Performance Data

4.9. SL869-T Timing Performance Data

PPS Accuracy (nsec)	Simulator			Open Sky	
	GPS Only	GPS + GLO	GPS (1 SV)	GPS Only	GPS + GLO
PPS Error (50%)	3.8	3.8	3.7	3.9	3.9
PPS Error (90%)	7.4	7.1	10.3	8.2	11.9
PPS Error (100%)	12.5	10.9	13.5	18	18.9

Table 3 – SL869 Timing (PPS) Accuracy (CDF)

Note: To calculate the CDF the RF & HW path delay is totally compensated and position hold enabled.



4.10. Dynamic Constraints

The SL869 receiver will lose track if any of the following limits are exceeded:

- ITAR limits: velocity greater than 515 m/s AND altitude above 18,000 m
- altitude: 100,000 m (max) or -1500 m (min)
- velocity: 600 m/s (max)
- acceleration: 2 G (max)



5. Electrical Requirements

5.1. Power Supply

5.1.1. VCC

This is the main power input. The supply voltage must be in the range 3.0V to 3.6V. Reference the HW User Guide for additional details.

5.1.2. VBATT

The battery backup power input range is 2.5V to 3.6V. It is required for HOT/WARM starts and retention of GPS data.

5.2. External Antenna Voltage

The SL869 requires an external antenna Bias-T to provide the voltage to the antenna.

5.3. RF (Radio Frequency) Input

The RF input is 1575.42 MHz to 1606 MHz (L1 Band) at a level between -135 dBm and -165 dBm into 50 Ohm impedance.

5.4. Antenna Gain

The receiver module will operate with a passive antenna with Isotropic gain down to a minimum of -6dBi. Active antennas are supported.

An active antenna between 20dB to 25dB (exiting the cable) will offer the best performance.

Note: The recommended total external gain range includes all external gain; antenna, external LNA, and any passive loss due to cables, connectors, filters, matching networks, etc.

5.5. Burnout Protection

The receiver accepts without risk of damage a signal of +10 dBm from 0 to 2 GHz carrier frequency, except in band 1560 to 1590 MHz where the maximum level is -10 dBm.



5.6. Jamming Performance

In-band jammers can be detected and removed using a 3-stage approach (RF, DSP and SW) pre-and post-correlation. This is over and above the excellent SAW filter response that exists before the GPS LNA input.

Note: The spectral purity of oscillators and RF transmitters in the host system will determine if harmonics are formed that are equal to the frequencies above.

Compact wireless product design requires close monitoring of jamming issues.

5.7. Flash Upgradability

The firmware programmed in the Flash memory may be upgraded via the serial port TX/RX pads. There are two different methods and two different firmware upgrade tools.

1. Using the TeseoII XLoader, the user can load firmware by driving the Serial BOOT select line low at startup, then downloading the code from a PC with suitable software. In normal operation this pad should be left floating for minimal current drain. It is recommended that in the user's application, the BOOT select pad is connected to a test pad for use in future software upgrades.
2. Using the Teseo2 Firmware Upgrade Tool, the user can reflash the receiver without driving the BOOT select line low, however this method only works if an existing firmware is already running and the NMEA port is available.

Refer to the User Guides for additional information on both modes.

5.8. Data Input/Output Specifications

All communications between the SL869 receiver and external devices are through the I/O surface mount pads. These provide the contacts for power, ground, serial I/O and control. Power requirements are discussed in the following sections.



5.8.1. Voltages and Currents

Parameter	Symbol	Min	Typ	Max	Unit
Power Supply Voltage	VCC	3.0	3.3	3.6	V
Operating Temperature	T _{OPR}	-40		85	°C
Current Consumption	ICC				mA
Navigation/Tracking:					
• GPS + GLO			42		
• GPS Only					
• GLO Only			38		
Acquisition:					
• GPS + GLO			67		
• GPS Only			58		
Low Power Mode:					
• GPS + GLO			30		
• GPS Only			22		
Battery Backup Supply	VBATT	2.5	3	3.6	V
Battery Backup Current	IBATT		73		uA
Operating temperature is ambient.					
Low Power mode uses a 500ms duty cycle setting.					

Table 4 – Power Requirements

Absolute Maximum Ratings

Parameter	Symbol	Rating	Units
Power Supply Voltage	VCC	3.6	V
Input Pin Voltage	VIO_IN	3.6	V
Output Pin Voltage	VIO_OUT	3.6	V
Storage Temperature	T _{stg}	-40°C to +85°C	°C
 Warning – Stressing the device beyond the “Absolute Maximum Ratings” may cause permanent damage. These are stress ratings only. Operation beyond the “Operating Conditions” is not recommended and extended exposure beyond the “Operating Conditions” may affect device reliability.			

Table 5 – Digital Core and I/O Voltage (Volatile)

5.8.2. DC Electrical Characteristics

5.8.2.1. TX and 1PPS

$V_{OL} = 0.4V$ MAX.

$V_{OH} = 2.9V$ MIN

Typical MAX current = + 12mA, -12mA.

Normal current = +100uA to +6mA (V_{OL}), -100uA to -6mA (V_{OH})

VCC = 2.85V to 3.3V typical, 3.6V MAX.

Internal 10K pull-up to VCC on TX only

5.8.2.2. RX

$V_{IL} = 0.8V$ MAX.

$V_{IH} = 2.0$ MIN

5.8.2.3. SDA2 and SCL2

Currently not supported in software

5.8.2.4. VDDUSB

$V_{IL} = 0.8V$ MAX.

$V_{IH} = 2.0$ MIN

5.8.2.5. BOOT

For normal operation, leave this pin floating. To place the SL869 into BOOT mode, tie this pin to Ground through a 1K pull down resistor.



5.8.3. Pinout Description

Details of the LGA pad functions are shown in Table 5.

Pad Number	Pad Function	Type	Description
1	CAN0TX ¹	O	CAN BUS TX
2	CAN0RX ¹	I	CAN BUS RX
3	1PPS	O	Timemark Pulse, 500ms active high
4	NC	I	No Connection
5	USB_DM ²	USB/O	USB D- / UART1 TX
6	USB_DP ²	USB/I	USB D+ / UART1 RX
7	USB_DETECT ²	PWR	USB Detect
8	NC	-	No connection
9	VCC	PWR	VCC
10	GND	PWR	Ground
11	RF_IN	I	GPS RF Input, 50 Ohm
12	GND	PWR	Ground
13	GND	PWR	Ground
14	TX2/BOOT ²	O/I	UART2 TX / BOOT (at power up)
15	RX2 ²	I	UART2 RX
16	NC	-	No connection
17	NC	-	No connection
18	SDA2 ¹	I/O	Sensor I2C Data Port
19	SCL2 ¹	I/O	Sensor I2C Clock Port
20	TX	O	UART TX
21	RX	I	UART RX
22	VBATT	PWR	Battery Backup Voltage
23	VCC	PWR	Main Supply Voltage
24	GND	PWR	Ground

Table 6 – LGA Pad Functions

Note: 1: Above designated pins are alternate functions for DR operation.
2: Above designated pins are only utilized for DR operation.



6. Software Interface

The host serial I/O port of the receiver's serial data interface supports full duplex communication between the receiver and the user.

The default serial configuration is as follows: NMEA, 9600 bps, 8 data bits, no parity, and 1 stop bit. For timing modules the default rate is 115200 bps.

More information regarding the software interface can be found in the Software User Guide.

Customers that have executed a Non-Disclosure Agreement (NDA) with Telit Wireless may obtain the Software Authorized User Guide, which contains additional proprietary information about the interface. Customers under an NDA may also obtain the Timing Software user Guide which contains additional proprietary information about the interface with respect to the timing features available in timing modules.

6.1. NMEA Output Messages

NMEA v2.20 is the default protocol in firmware versions prior to 3.1.6. Otherwise the default protocol is v3.01.

6.1.1. Standard Messages

The following messages are output by default:

- GPRMC = 1 second update
- GPGGA = 1 second update
- GNGSA = 1 second update
- GPGSV = 1 second update
- GLGSV = 1 second update

A GNGSA message is output for each enabled GNSS constellation. By default the GPS and GLONASS constellations are enabled. If QZSS is enabled, QZGSV messages are also output each second when QZSS satellites are visible.

Other NMEA-defined messages are supported by the SL869, including GLL, VTG and ZDA messages.

6.1.2. Proprietary Messages

The SL869 supports a set of proprietary NMEA output messages which report additional receiver data and status information on a periodic basis.

6.2. NMEA Commands

The SL869 has a user command interface that uses NMEA proprietary messages for commands and command responses. This interface provides configuration and control over certain firmware features and operational properties of the module.



7. Mechanical Drawing

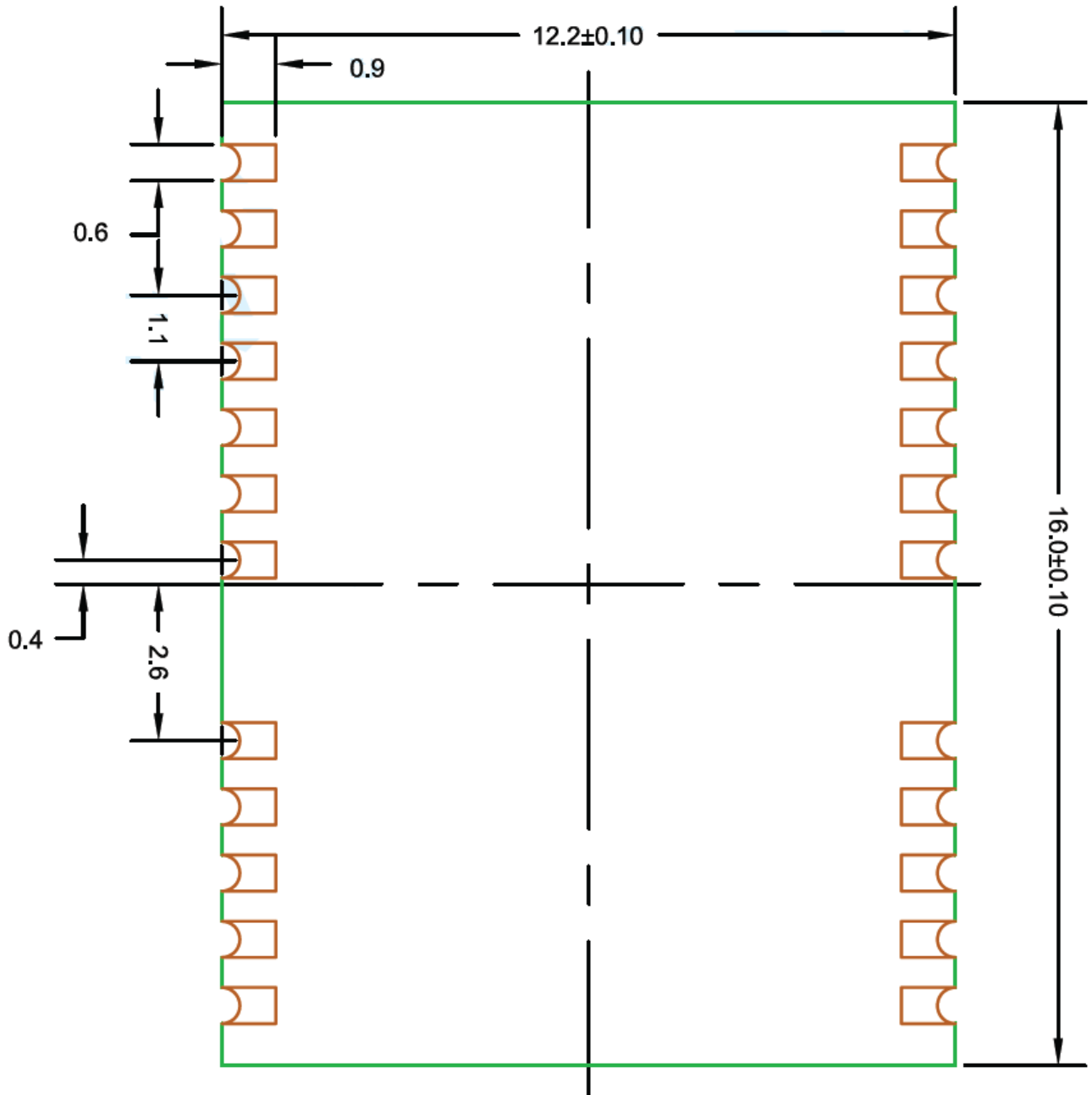

Figure 2 Bottom-Side Pads
Dimensions are in mm



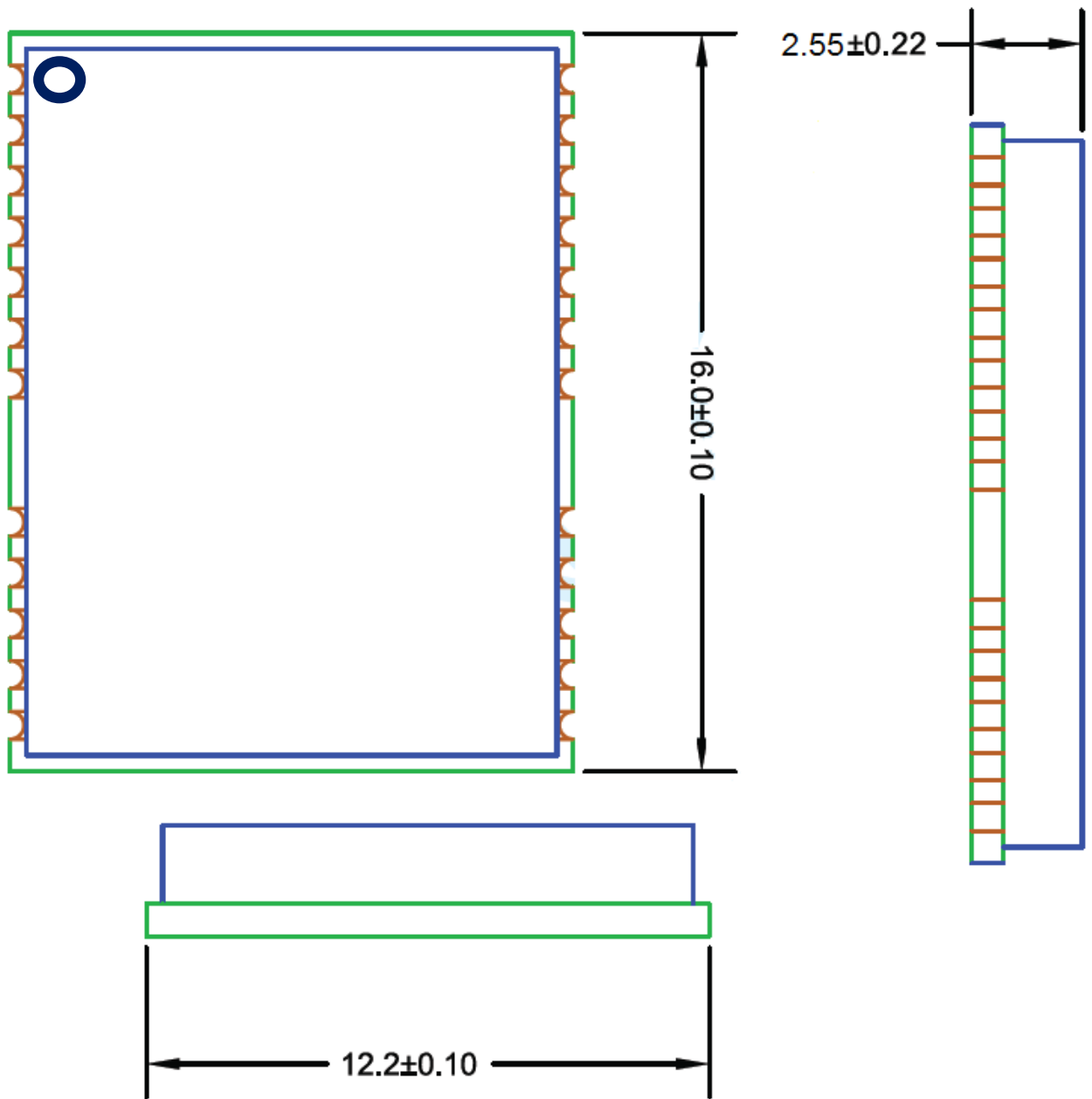

Figure 3 Package Outline Drawing (Top View)
Dimensions are in mm



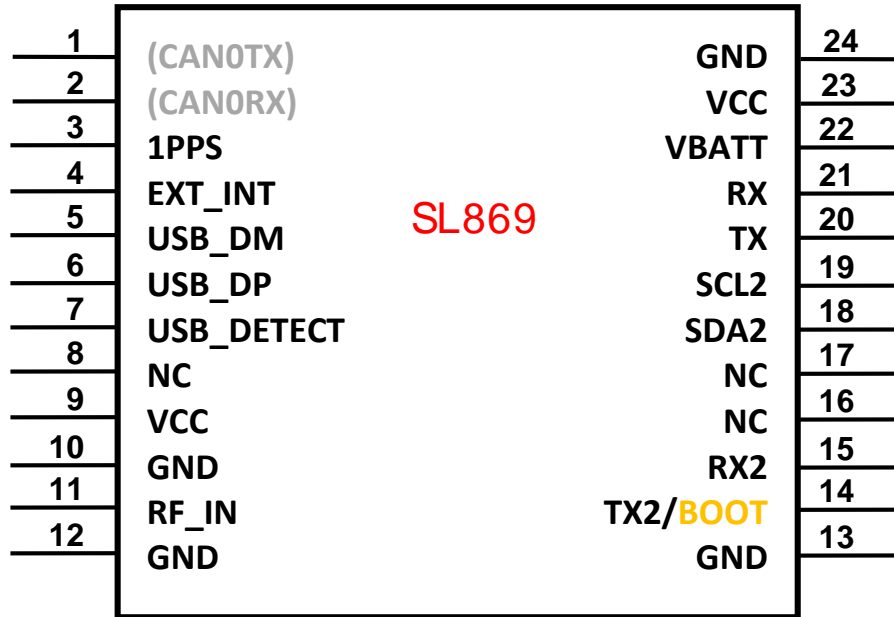

Figure 4 Pinout (Top View)

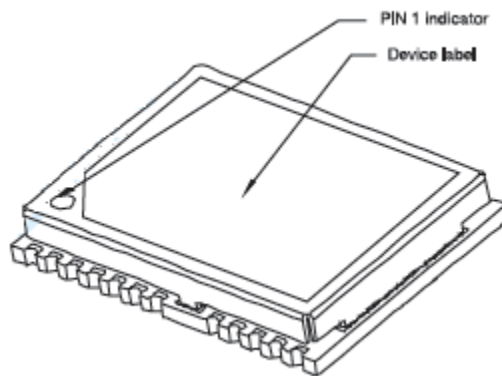

Figure 5 3D Model



8. Evaluation Kit

The SL869 Development Kit is available to assist in the evaluation and integration of the SL869 module in custom applications. The Development Kit contains all of the necessary hardware and software to carry out a thorough evaluation of the SL869 module.

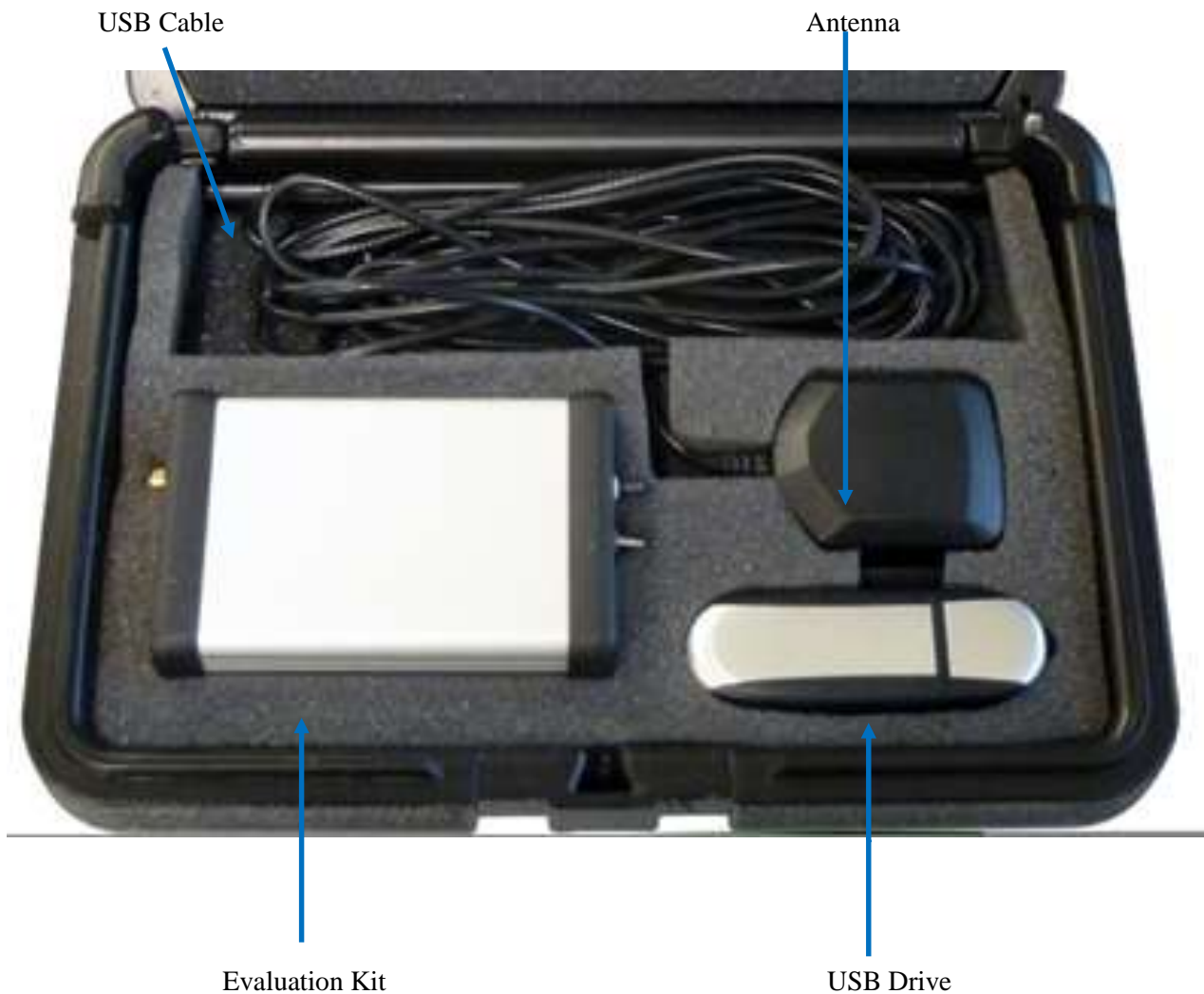

Figure 6 SL869 EVK



9. Product Compatibility

The SL869 offers the same footprint as the J-N3 Product Family. It is pin-to-pin compatible with the J-N3 except that the BOOT pin is relocated from pin 7 to pin 14. Pin 7 is USB_DETECT.

The SL869 GNSS module can be used in place of a J-N3 GPS module provided that reprogramming is not required and that the signal specifications called out in this document are supported by the customer design.

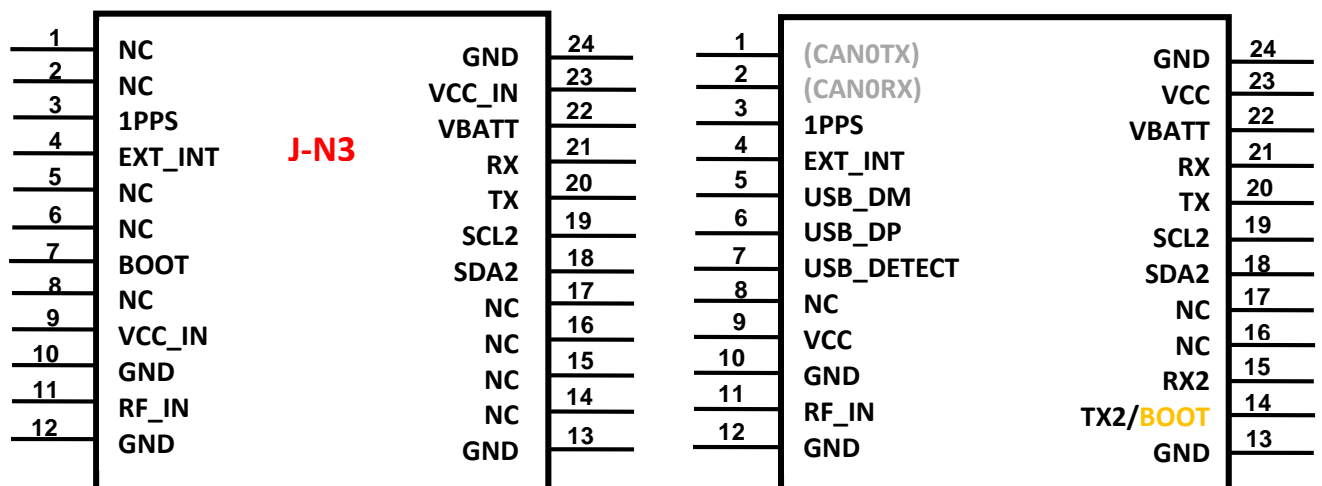

Figure 7 J-N3 vs. SL869 Pin-out Differences



Note: Power Supply and Battery Back-up ranges differ as well. Refer to HW Designer Notes for more details.



10. Product Handling

10.1. Product Packaging and Delivery

SL869 modules are shipped in Tape and Reel form. The reeled modules are shipped in 24mm reels with 1000 units per reel. Each reel is ‘dry’ packaged and vacuum sealed in a Moisture Barrier Bag (MBB) with two silica gel packs and placed in a carton.

The minimum order quantity for shipping is 1000 units. Refer to the HW User Guide for additional details.

All packaging is ESD protective lined. The SL869 GPS receiver is a Moisture Sensitive Device (MSD) level 3. Please follow the MSD and ESD handling instructions on the labels of the MBB and exterior carton (refer to sections 8.2 and 8.3).

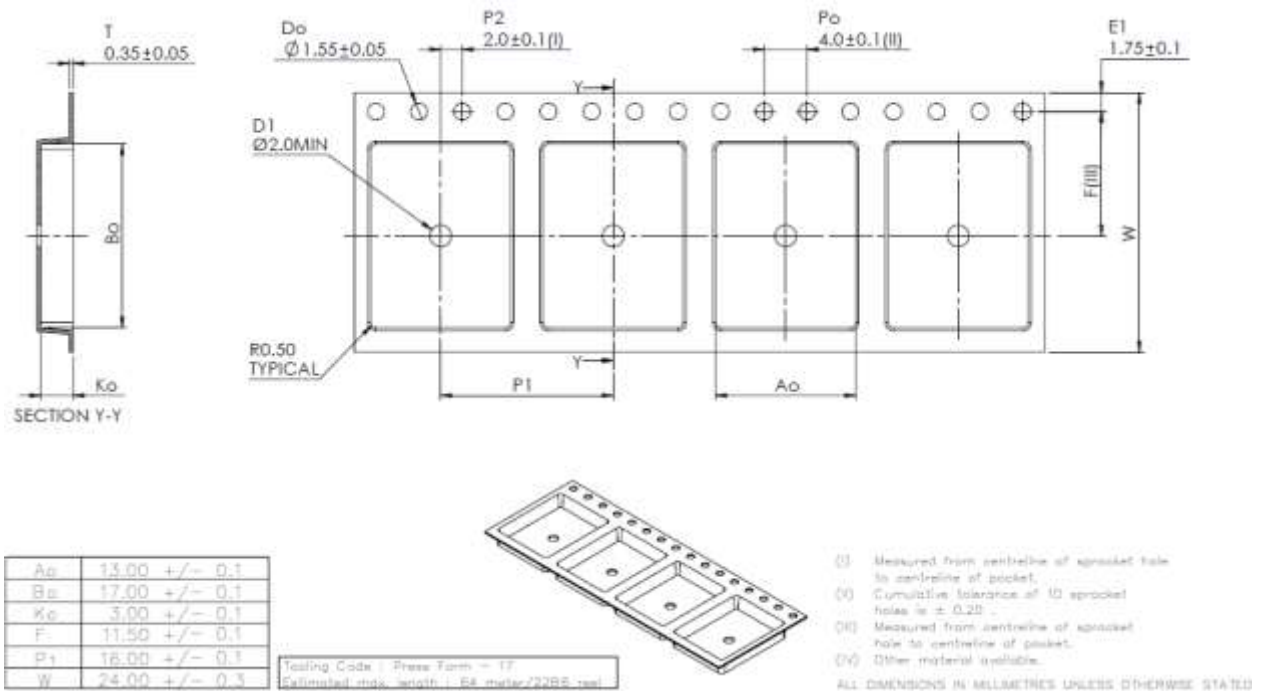

Figure 8: Tape and Reel Packaging

SL869 modules are also available in trays. The modules are shipped in trays with 72 units per tray. Five trays are ‘dry’ packaged and vacuum sealed in a Moisture Barrier Bag (MBB) with silica gel pack, humidity indicator and placed in a carton.



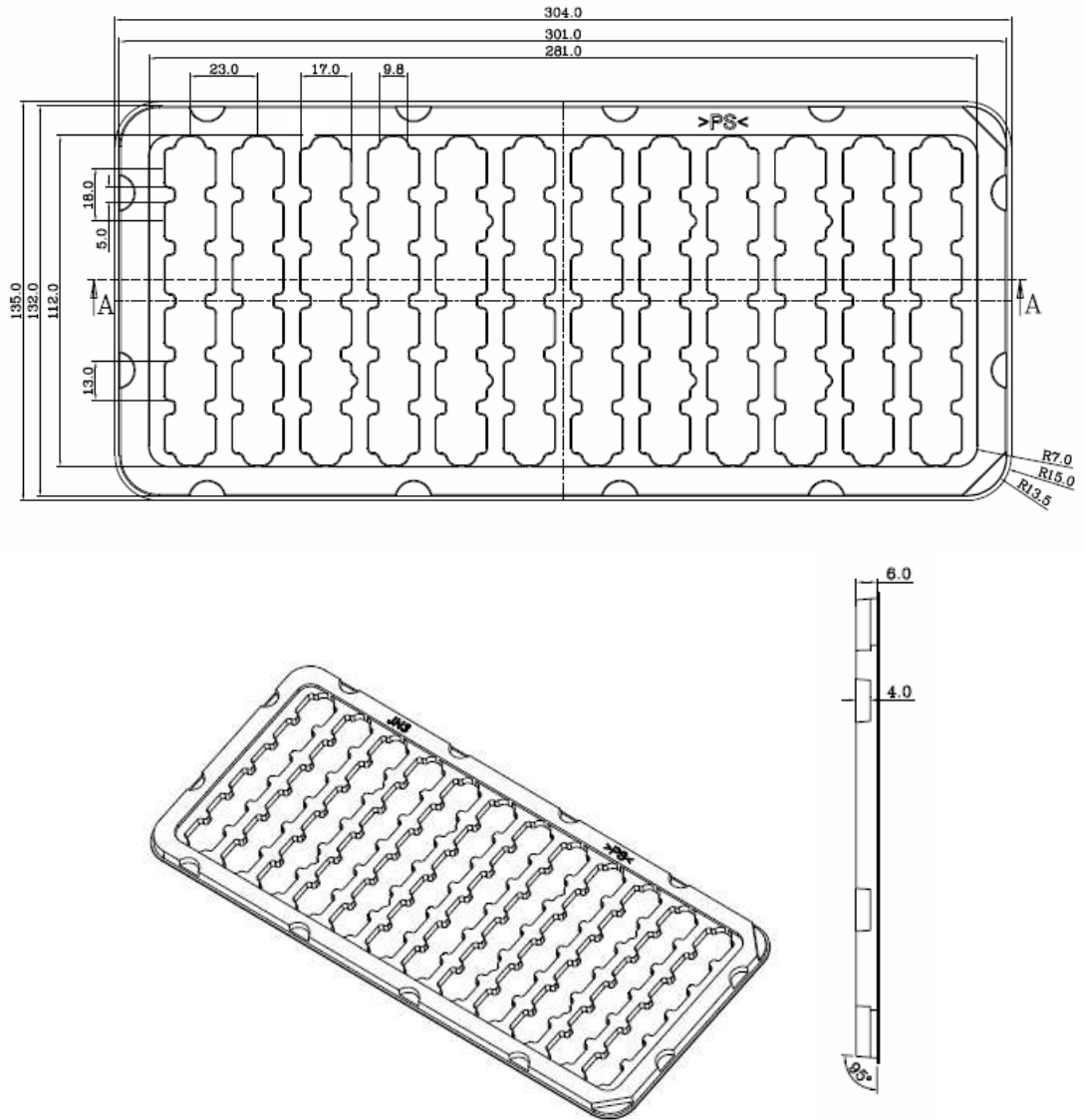

Figure 9: Tray Packaging



10.2. **Moisture Sensitivity**

Precautionary measures are required in handling, storing and using such devices to avoid damage from moisture absorption. If localized heating is required to rework or repair the device, precautionary methods are required to avoid exposure to solder reflow temperatures that can result in performance degradation.

Further information can be obtained from the IPC/JEDEC standard J-STD-033: Handling, Packing, Shipping and Use of Moisture/Reflow Sensitive Surface Mount Devices.

10.3. **ESD Sensitivity**

The SL869 GNSS receiver contains class 1 devices and is Electro-Static Discharge Sensitive (ESDS). Telit recommends the two basic principles of protecting ESD devices from damage:

Only handle sensitive components in an ESD Protected Area (EPA) under protected and controlled conditions.

Protect sensitive devices outside the EPA using ESD protective packaging. All personnel handling ESDS devices have the responsibility to be aware of the ESD threat to the reliability of electronic products.

Further information can be obtained from the JEDEC standard JESD625-A, Requirements for Handling Electrostatic Discharge Sensitive (ESDS) Devices.

10.4. **Safety**

Improper handling and use of the GNSS receiver can cause permanent damage to the receiver. There is also the possible risk of personal injury from mechanical trauma or choking hazard.

10.5. **Disposal**

We recommend that this product should not be treated as household waste. For more detailed information about recycling this product, please contact your local waste management authority or the reseller from whom you purchased the product.



11. Conformity Assessment

11.1. CE Conformity Declaration



CE DECLARATION OF CONFORMITY

1. Product: SL869

2. Manufacturer: Telit Wireless Solutions, 27422 Portola Parkway, Suite 320, Foothill Ranch, CA 92610 - USA

3. This declaration of conformity is issued under the sole responsibility of the manufacturer

4. Stand-alone GNSS receiver module



5. The object of the declaration described above is in conformity with the relevant Community harmonisation:
European Directive 1999/05/EC (R&TTE)

6. The conformity with the essential requirements of the 1999/05/EC has been demonstrated against the following harmonized standards:

EN 60950-1:2006 + A11:2009 + A1:2010 + A12:2011 + AC:2011	For article 3.1 (a): Health and Safety of the User
EN 301 489-1 V1.9.2 EN 301 489-3 V1.4.1	For article 3.1 (b): Electromagnetic Compatibility
EN 300 440-2 v.1.4.1	For article 3.2 : Effective use of spectrum allocated

7. The conformity assessment procedure referred to in Article 10 and detailed in Annex V of Directive 1999/05/EC has been followed with the involvement of the following Notified Body:
CETECOM ICT Services GmbH Untertürkheimer Straße 6-10, D-66117 Saarbrücken, Germany.
Notified Body Number: 0682
Thus, **CE 0682** is affixed to the device label, the packaging, if it exists, and to the accompanying documents.

8. The Technical Construction File (TCF) relevant to the product described above and which supports this Declaration of Conformity, is held at: Telit Communications S.p.A Via Stazione di Prosecco, 5/b 34010 Sgonico (TRIESTE) ITALY

Signed for and on behalf of Telit Location Solution LP and Telit Communications S.p.A

Trieste, 2014-06-26



Quality Director, Telit Communications SpA
Guido Walcher



VP Telit GNSS Solutions
Georgia Frousiakis

Technical Construction File : 30405TCF0043 Rev.0

Mod 0211 2012-11 Rev 2 - This declaration of conformity is issued in compliance with 768/2008/EC



11.2. R&TTE Notified Body Opinion

CETECOM ICT Services GmbH
EC Identification Number 0682
authorized by the German Government
 Bundesnetzagentur
BNetzA-bS-02/51-52
to act as Notified Body in accordance with the R&TTE Directive 1999/5/EC of March 9, 1999.

EXPERT OPINION

Registration-No.: **U816665Z-EO**
Applicant & Product Manufacturer: **Telit Location Solutions**
27422 Portola Parkway, Suite 320
Foothill Ranch, CA 92610 U.S.A.

Product Designation: **SL869**
Product Description: **stand-alone GNSS receiver module**

essential requirement (R&TTE-D article)	Specifications / Standards	Submitted documents	Result
Safety and Health (art. 3.1a)	IEC 60950-1: 2005 (2nd Edition)/A1:2009 and EN 60950-1:2006/A11:2009/A1:2010/A12:2011	Test Report	conform
EMC (art. 3.1b)	EN 301 489-1:V1.8.1, EN 301 489-3:V1.4.1;	Test Report	conform
Radio spectrum (art. 3.2)	EN 300 440-1:V1.6.1, EN 300 440-2:V1.4.1;	Test Report	conform

Marking: The EC conformity marking (CE mark) of the products shall be accompanied by our EC identification number 0682 as shown right hand. **CE 0682**

The scope of this evaluation relates to the submitted documents only.
The certificate is only valid in conjunction with the following annex.

Milpitas, 2012-08-02
Place, Date of Issue



Signed by Nikolaus Wahl
Notified Body



CETECOM ICT Services GmbH, Untertürkheimer Straße 6-10, 66117 Saarbruecken, Germany
<http://www.cetecom-ict.de>



11.3. RoHS Declaration



EU RoHS DECLARATION OF CONFORMITY

1. Product name: **SL869**
2. Manufacturer: Telit Location Solutions LP, 27422 Portola Parkway, Suite 320, Foothill Ranch, CA 92610, USA
3. This declaration of conformity is issued under the sole responsibility of the manufacturer.
4. Object of declaration: Stand-alone GNSS receiver module



5. The object of declaration described above is in conformity with Directive 2011/65/EU of the European Parliament and of the Council of 8 June 2011 on the restriction of the use of certain hazardous substances in electrical and electronic equipment
6. The conformity with the applicable requirements of the Directive 2011/65/EU has been demonstrated against the following harmonized standard:

EN 50581:2012	Technical documentation for the assessment of electrical and electronic products with respect to the restriction of hazardous substances
---------------	------------------------------------------------------------------------------------------------------------------------------------------
7. The technical documentation relevant to the product described above and which supports this Declaration of Conformity, is held at: Telit Communications S.p.A Via Stazione di Prosecco, 5/b 34010 Sgonico (TRIESTE) ITALY.

Signed for and on behalf of Telit Location Solutions LP

Foothill Ranch, 2013-05-06

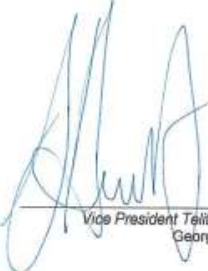

Vice President Telit Location Solutions LP
George Amott

Mod 0216 2013-01 Rev.4 - This Declaration of Conformity is issued in compliance with 768/2008/EC



12. Glossary and Acronyms

AGPS: Assisted GPS. AGPS uses additional resources to locate the satellites faster and better in poor signal conditions.

Almanac: A set of orbital parameters that allows calculation of approximate GPS satellite positions and velocities. The almanac is used by a GPS receiver to determine satellite visibility and as an aid during acquisition of GPS satellite signals. The almanac is a subset of satellite ephemeris data and is updated weekly by GPS Control.

CDF: Cumulative Distributive Function; In probability theory and statistics, the cumulative distribution function (**CDF**), or just distribution function, describes the probability that a real-valued random variable X with a given probability distribution will be found at a value less than or equal to x . In the case of a continuous distribution, it gives the area under the probability density function from minus infinity to x . Cumulative distribution functions are also used to specify the distribution of multivariate random variables.

EGNOS: European Geostationary Navigation Overlay Service
The system of geostationary satellites and ground stations developed in Europe to improve the position and time calculation performed by the GPS receiver.

Ephemeris plural ephemerides: A set of satellite orbital parameters that is used by a GPS receiver to calculate precise GPS satellite positions and velocities. The ephemeris is used to determine the navigation solution and is updated frequently to maintain the accuracy of GPS receivers.

ESD: Electro-Static Discharge
Large, momentary, unwanted electrical currents that cause damage to electronic equipment.

GDOP: Geometric Dilution of Precision.
A factor used to describe the effect of the satellite geometry on the position and time accuracy of the GPS receiver solution. The lower the value of the GDOP parameter, the less the error in the position solution. Related indicators include PDOP, HDOP, TDOP and VDOP.

GPS: Global Positioning System.
A space-based radio positioning system that provides accurate position, velocity, and time data.

LGA: Land Grid Array.
There are no pins on the chip; in place of the pins are pads of bare gold-plated copper that touch pins on the motherboard.

Local Ephemeris prediction data. AGPS using prediction of ephemeris from live (downloaded from satellites), ephemeris stored in memory. Useful for up to three days.

MSD: Moisture sensitive device.

NMEA: National Marine Electronics Association

SBAS: Satellite Based Augmentation System
Any system that uses a network of geostationary satellites and ground stations to improve the performance of a Global Navigation Satellite System (GNSS). Current examples are EGNOS and WAAS.



Server-based Ephemeris prediction data. Eliminates the initial delay of obtaining GPS satellite location data from the satellites themselves by using algorithms to predict seven days of satellite location data.

WAAS: Wide Area Augmentation System

The system of satellites and ground stations developed by the FAA (Federal Aviation Administration) that provides GPS signal corrections. WAAS satellite coverage is currently only available in North America.



13. Safety Recommendations

READ CAREFULLY

Be sure the use of this product is allowed in the country and in the environment required.

Do not disassemble the product; any mark of tampering will compromise the warranty validity. We recommend following the instructions of the hardware user guide for a correct wiring of the product. The product has to be supplied with a stabilized voltage source, and the wiring has to be conforming to security and fire prevention regulations. The product has to be handled with care, avoiding any contact with the pins, because electrostatic discharges may damage the product itself.

The system integrator is responsible for the functioning of the final product. Should there be any doubt, please refer to the technical documentation and the regulations in force. Every module has to be equipped with a proper antenna with specific characteristics. The antenna has to be installed with care in order to avoid any interference with other electronic devices.

The European Community provides some Directives for electronic equipment introduced into the market. All the relevant information is available on the European Community website:

<http://ec.europa.eu/enterprise/sectors/rte/documents/>

The text of Directive 99/05 regarding telecommunication equipment is available, while the applicable Directives (Low Voltage and EMC) are available at:

<http://ec.europa.eu/enterprise/sectors/electrical/>



14. Document History

Revision	Date	Changes
0	2012-04-26	First issue
1	2012-07-25	5.8.3 and 9 added warning about USB functionality on SL869 variants
2	2012-08-08	Updated performance data, NMEA output messages, DC electrical Characteristics, and Figure 2&3
3	2013-02-12	Updated NMEA messages, signals and figures for Rev F module.
4	2013-04-10	Update height information
5	2013-11-20	Added an SL869 Family of Products description. Updated Performance and Timing Characteristics to include new features added by recent firmware versions. Updated/ added to Software Interface section.
6	2014-09-15	Updated Timing characteristics: added §4.3, §4.6 and §4.9 Updated CE Declaration of Conformity §11.1 Updated RoHS Declaration §11.3

