



USB 2.0 Ranger[®] 2304

4-Port USB 2.0 100m Cat 5e Extender System

User Guide



Thank you for purchasing the USB 2.0 Ranger® 2304.

Please read this guide thoroughly.

This document applies to Part Numbers: 00-00347, 00-00348, 00-00349, and 00-00350.

FCC Radio Frequency Interference Statement Warning

This device complies with Part 15 of the FCC rules. Operation is subject to the following two conditions: (1) this device may not cause harmful interference, and (2) this device must accept any interference received including interference that may cause undesired operation.

CE Statement

We, Icron Technologies Corporation, declare under our sole responsibility that the Ranger 2304, to which this declaration relates, is in conformity with European Standard EN 55022, EN 55024, EN 61000-3-2, and EN 61000-3-3.

IC Statement

This Class B digital apparatus complies with Canadian ICES-003.

©2013 Icron Technologies Corporation. All rights reserved. Icron Technologies Corporation, the Icron Technologies Corporation logo, and the Icron Technologies Corporation products referred to herein are either the trademarks or the registered trademarks of Icron Technologies Corporation. All other trademarks are property of their respective owners. Icron Technologies Corporation assumes no responsibility for errors that may appear in this manual. Information contained herein is subject to change without notice.

Document #90-01105-A01

Contents

Introduction	3
Ranger 2304-LAN Product Contents	3
Features	3
The LEX Unit	4
The REX Unit.....	5
Installation Guide	6
Installing the Ranger 2304-LAN System on a Local Area Network.....	6
Requirements	6
Preparing your Network	6
Preparing Your Site	7
Installing the LEX Unit	7
Installing the REX Unit	7
Installing the Ranger 2304-LAN System as Direct Connect	8
Requirements	8
Preparing Your Site	8
Installing the LEX Unit	9
Connecting the LEX Unit to the REX Unit	9
Installing the REX Unit	9
Checking the Installation	10
Connecting a USB Device.....	11
Pairing the LEX and REX.....	11
Unpairing a Unit	11
Compatibility	11
Troubleshooting	12
Contacting Technical Support	14
Warranty Information	14
Obtaining Warranty Service	15
Contacting Sales	15
Contacting Technical Support	15
Technical Glossary	16
Specifications	17

Introduction

This guide provides product information for the Ranger 2304 installation instructions, troubleshooting guidelines, and instructions for contacting Icron regarding technical support and warranty information.

The instructions in this guide assume a general knowledge of computer installation procedures, familiarity with cabling requirements, and some understanding of USB devices.

 NOTE: Notes provide additional information that could be useful.

 CAUTION: Cautions provide important information about an operational requirement.

Ranger 2304 Product Contents

Your Ranger 2304 is packaged with:

- LEX Unit (Local Extender)
- REX Unit (Remote Extender)
- USB 2.0 Cable
- REX AC International Power Adapter
- Country Specific Power Cable
- Quick Start Guide and Warranty Information

Features

The Ranger 2304 incorporates Icron's patented ExtremeUSB® technology, enabling users to extend USB beyond the standard 5m cable limit for USB 2.0 peripheral devices. The Ranger 2304 has the following key features:

- 100m of extension when directly connected over Cat 5e
- Support for new USB 3.0 host controllers and devices over previous Ranger products
- Support for bulk and HID type devices (storage and mouse/keyboard types)

 NOTE: USB 3.0 devices will perform at USB 2.0 speeds if extended through the Ranger 2304.

The Ranger 2304 extender system is composed of two individual units: the LEX unit and the REX unit.

 NOTE: All references to Cat 5e cable in this document represent the minimum requirement. Category 6 or better and/or STP cable may be substituted.

The LEX Unit

The Local Extender (LEX) unit connects to the computer using a standard USB 2.0 cable. Power for this unit is provided by the the host computer.

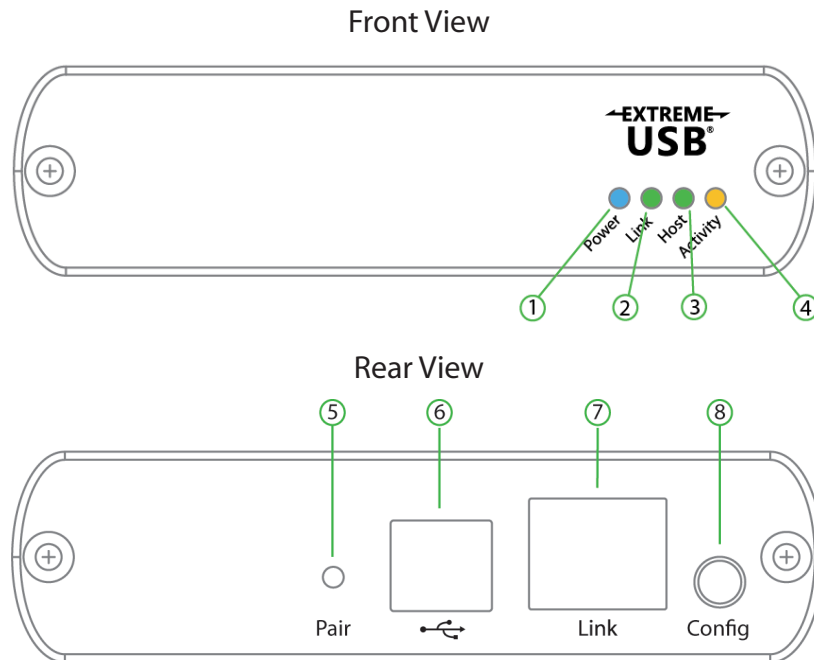

ITEM	TYPE	DESCRIPTION
1	Power LED (Blue)	LED turns on when power is supplied, off when no power is supplied by the Host computer.
2	Link LED (Green)	Indicates a valid ExtremeUSB link is established between the LEX and REX units. The LED turns on when link between LEX and REX is established and off when there is no link between LEX and REX. Slow blinking indicates the unit is attempting to establish a link.
3	Host LED (Green)	Indicates that the Ranger 2304 system is properly enumerated on the host computer. The LED blinks when the Ranger 2304 is in a suspended state.
4	Activity LED (Amber)	Indicates data transmission is occurring between LEX and REX. LED blinks intermittently with or without a USB device connected. When the LEX and REX are in suspend mode, the LED is off.
5	Pair	Reserved for manufacturer use.
6	USB Host Port	Used to connect the LEX unit to the host computer. Accepts Type B connector into the LEX unit.
7	Link Port (RJ45)	Accepts RJ45 connector for Cat 5e cabling (or better) to connect the LEX unit to the REX unit.
8	Config	Reserved for manufacturer use.

The REX Unit

The Remote Extender (REX) unit provides USB Type A ports for standard USB devices. The REX unit allows you to connect up to four USB devices directly. Additional devices may be connected by attaching USB hubs to the REX unit. The REX unit is powered by an external AC adapter and can supply up to 500mA to each USB port.

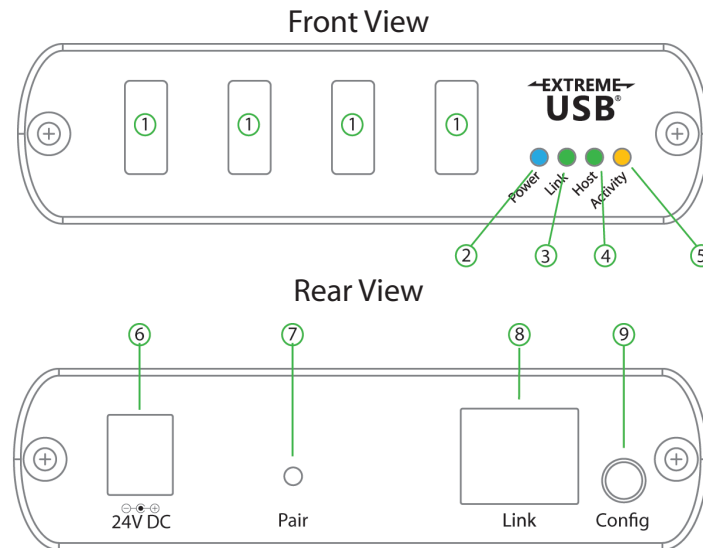

ITEM	TYPE	DESCRIPTION
1	USB Device Ports	Accepts USB device(s) using Type A connectors.
2	Power LED (Blue)	LED turns on when power is supplied, off when no power is supplied.
3	Link LED (Green)	Indicates a valid ExtremeUSB link is established between the LEX and REX units. The LED turns on when link between LEX and REX is established and off when there is no link between LEX and REX. Slow blinking indicates the unit is attempting to establish a link.
4	Host LED (Green)	Indicates that the Ranger 2304 system is properly enumerated on the host computer. The LED blinks when the Ranger 2304 is in a suspended state.
5	Activity LED (Amber)	Indicates data transmission is occurring between LEX and REX. LED blinks intermittently with or without a USB device connected. When the LEX and REX are in suspend mode, the LED is off.
6	Power Port	Connects to the AC power supply. Required at REX for proper operation.
7	Pair	Reserved for manufacturer use.
8	Link Port (RJ45)	Accepts RJ45 connector for Cat 5e cabling (or better) to connect the LEX unit to the REX unit.
9	Config	Reserved for manufacturer use.

Installing the Ranger 2304 System

Requirements

To complete the installation, you will also require the following items that are not included with the product:

- USB compatible computer (host computer) with a USB compliant operating system
- USB compatible device(s)
- Cat 5e Unshielded Twisted Pair (UTP) cable with two RJ45 connectors (if using surface cabling), OR, Cat 5e cabling with two information outlets and two Cat 5e patch cords with RJ45 connectors (if using premise cabling)

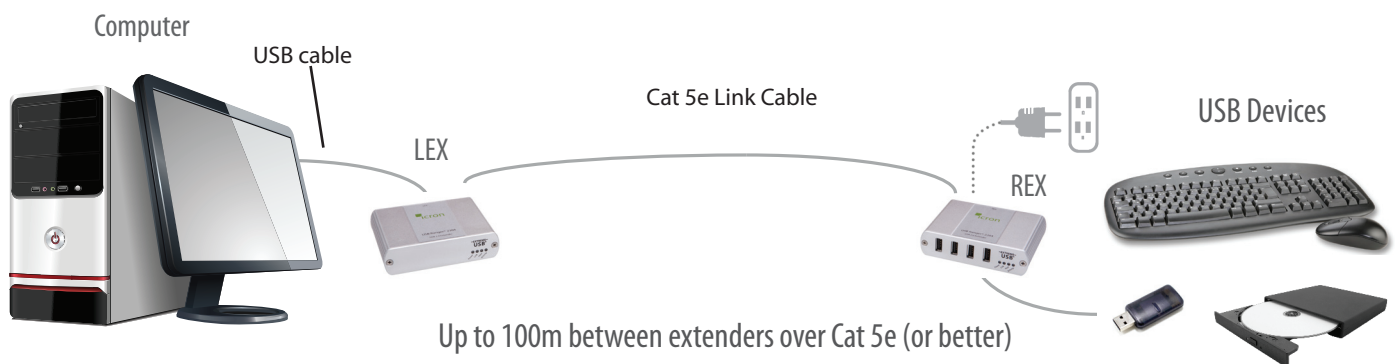

Preparing Your Site

Before you can install the Ranger 2304, you need to prepare your site:

1. Place the computer where desired and set it up.
2. Ensure that where you want to locate the USB device(s) is within 100m (cable-length) of the computer. If not, adjust the location of the devices and/or computer accordingly.
3. If you are using surface cabling, install the Cat 5e cabling as desired and terminate it with the appropriate RJ45 ends.

If you are using premise cabling, ensure Cat 5e cabling is installed between the two locations and if necessary patched together. Cat 5e information outlets should be located near the computer and the USB device(s), and the total length, including patch cords must be less than 100m.

- ! Cable installation is important, particularly if high throughput applications are used. When installing, ensure the cable is installed away from or isolated from potential sources of interference such as electrical wiring, flourescent lighting, etc.

note When terminating cables, ensure the matching RJ45 connector is used for the cable type. For example, if Cat 6 cable is used, then Cat 6 compatible RJ45 connectors must be used. If this care is not taken, the benefits of higher grade cabling may not be realized.

Installing the LEX Unit

1. Place the LEX unit near the computer.
2. Connect the supplied USB cable between the LEX host port and a USB port on the host computer.

Connecting the LEX Unit to the REX Unit

With Surface Cabling

1. Connect the Cat 5e cable into the Link port of the LEX unit.
2. Connect the Cat 5e cable into the Link port of the REX unit.

With Premise Cabling

1. Connect a Cat 5e patch cable (not provided) into the information outlet near the host computer.
2. Connect the patch cable into the Link port of the LEX unit.
3. Connect a Cat 5e patch cable (not provided) into the information outlet near the USB devices.
4. Connect the patch cable into the Link port of the REX unit.

Installing the REX Unit

1. Place the REX unit near the USB device(s).
2. Assemble the power adapter and country specific power cord together and connect them into a suitable AC outlet.
3. Connect the power adapter to the REX unit.

Checking the Installation

1. On the LEX and REX units, check that the Power, Status, Link and Host LEDs are on.
 - If the Host or Link LEDs are permanently off, then the cabling between the LEX and REX units may not be installed properly or is defective.
2. For Windows users (XP, 7, 8), open Device Manager to confirm that the Ranger 2304 has installed correctly. Expand the entry for Universal Serial Bus controllers by clicking the “+” sign. If the Ranger 2304 has been installed correctly, you should find it listed as a “Generic USB Hub”.



To open Device Manager in Windows XP:

Right click “My Computer” then select: Properties >> Hardware tab >> Device Manager



To open Device Manager in Windows 7 or 8

Open the Start menu, right click on “Computer” then select: Manage >> Device Manager

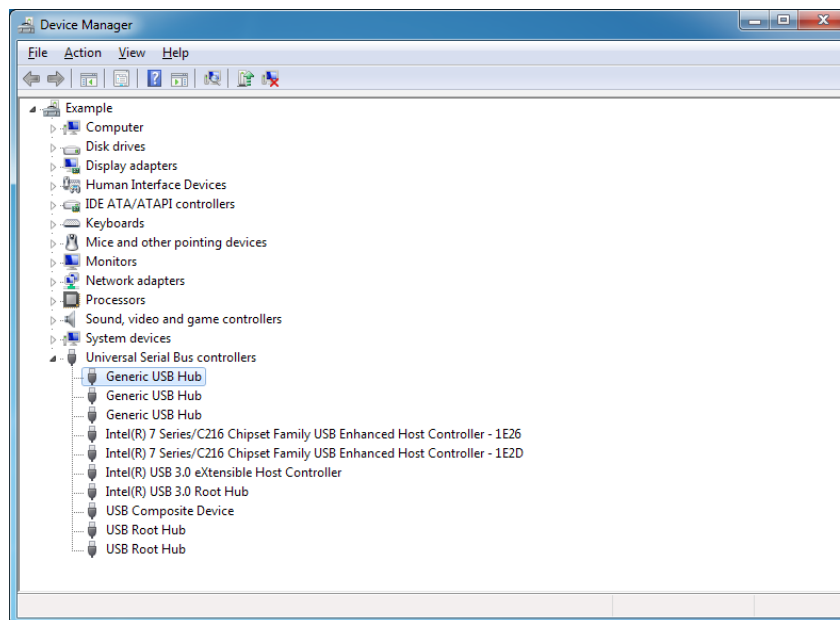

3. For Mac OS X users, open the System Profiler to confirm that the Ranger 2304 has installed correctly. In the left hand column under Hardware, select “USB” and inspect the right hand panel. If the Ranger 2304 has been installed correctly, you should find it listed as a “Hub” under the USB High-Speed Bus/USB Bus.



To open System Profiler in OS X: Open the Finder, select Applications, then open the Utilities folder and double click on the System Profiler icon.

4. If the Ranger 2304 is not detected correctly or fails to detect, please consult the Troubleshooting Section later in this guide.

Connecting a USB Device

1. Install any software required to operate the USB device(s). Refer to the documentation for the USB device(s), as required.
2. Connect the USB device to the device port on the REX unit.
3. Check that the device is detected and installed properly in the operating system.

Compatibility

The USB 2.0 Ranger 2304 complies with USB 1.1 and USB 2.0 specifications governing the design of USB devices. However, Icron Technologies Corporation does not guarantee that all USB devices or hosts will be compatible with the Ranger 2304, as there are a number of different characteristics that may impact the operation of USB devices over extended distances.

Troubleshooting

The following table provides troubleshooting tips. The topics are arranged in the order in which they should be executed in most situations. If you are unable to resolve the problem after following these instructions, please contact Technical Support for further assistance.

PROBLEM	CAUSE	SOLUTION
All LEDs on LEX unit are off.	<ul style="list-style-type: none"> The LEX unit is not receiving power from the USB port. 	<ol style="list-style-type: none"> Ensure that the host computer is connected to the LEX. Move the USB connector to another USB port on the host computer.
All LEDs on REX unit are off.	<ul style="list-style-type: none"> The REX unit is not receiving power from the AC adapter. 	<ol style="list-style-type: none"> Ensure that the AC power adapter is properly connected to the REX unit. Check that the AC adapter is connected to a live source of electrical power. Check that the REX power LED is illuminated.
Link LEDs on LEX unit and REX unit are off.	<ul style="list-style-type: none"> There is no connection between the LEX unit and REX unit. 	<ol style="list-style-type: none"> Ensure Cat 5e cable is connected between the LEX unit and REX unit. Cat 5e or better cable, UTP with a straight through connector and no crossovers, and 8 conductor RJ45 connectors are used at both ends. Connect a short Cat 5e patch cord between the LEX unit and REX unit to determine if the original Cat 5e cable is defective.
Link LEDs are blinking.	<ul style="list-style-type: none"> There is no connection between the LEX unit and REX unit. 	<ol style="list-style-type: none"> Ensure both the LEX and REX units are connected directly together directly.
Link LED on LEX unit is on, Host LED on LEX unit is off.	<ul style="list-style-type: none"> The host computer is not powered on. The LEX unit is not connected to the computer . The host computer is not recognizing the LEX. The computer does not support USB hubs. The Ranger 2304 is malfunctioning. 	<ol style="list-style-type: none"> Disconnect all USB devices from the REX unit. Disconnect the LEX unit from the computer. Disconnect the REX unit from the AC power adapter. Reconnect the LEX unit to the computer. Reconnect the REX unit to the AC power adapter. In the Universal Serial Bus controllers section of Device Manager, check that the Ranger 2304 is recognized as a "Generic USB Hub".

Contacting Technical Support

If you are experiencing problems not referenced in the Troubleshooting section, you may contact **Icron Technical Support** at icron.com/support.

Warranty Information

Limited Hardware Warranty

Icron Technologies Corporation warrants that any hardware products accompanying this documentation shall be free from significant defects in material and workmanship for a period of **two years from the date of purchase**. Icron Technologies Corporation's hardware warranty extends to Licensee, its customers, and end users.

The Warranty does not include repair of failures caused by: misuse, neglect, accident, modification, operation outside a normal operating environment, failure caused by service of the device by non-authorized servicers, or failure caused by a product for which Icron Technologies Corporation is not responsible.

Hardware Remedies

Icron Technologies Corporation's entire liability and the Licensee's exclusive remedy for any breach of warranty, shall be, at Icron Technologies Corporation's option, either (a) return of the price paid or (b) repair or replacement of hardware, which will be warranted for the remainder of the original warranty period or 30 days, whichever is longer. These remedies are void if failure of the hardware has resulted from accident, abuse, or misapplication.

Limitation of Liability

The hardware warranty set forth in this agreement replaces all other warranties. Icron Technologies Corporation expressly disclaims all other merchantability and fitness for a particular purpose and noninfringement of third-party rights with respect to the hardware.

Icron Technologies Corporation dealer, agent, or employee is authorized to make any modification extension, or addition to this warranty. Under no circumstances will Icron Technologies Corporation, its suppliers or licensors be liable for any costs of procurement or substitute products or services, lost profits, loss of information or data, or any other special, indirect, consequential, or incidental damages arising in any way out of the sale of, use of, or inability to use Icron Technologies Corporation product or service, even if Icron Technologies Corporation, its suppliers or licensors have been advised of the possibility of such damages. In no case shall Icron Technologies Corporation, its suppliers and licensors' liability exceed the actual money paid for the products at issue.

Since some jurisdictions do not allow the limitation of implied warranties of liability for incidental, consequential, special or indirect damages, the above limitation may not always apply. The above limitation will not apply in case of personal injury where and to the extent that applicable law requires such liability.

Obtaining Warranty Service

To obtain warranty service, you must first contact Icron Technologies Corporation within the warranty period for a Return Material Authorization (RMA) number. Icron Technologies Corporation will not accept returns without an authorized RMA number. Be sure you have the serial numbers of the local extender and remote extender before calling. Package the product appropriately for safe shipment and mark the RMA number on the outside of the package. The package must be sent prepaid to Icron Technologies Corporation. We recommend that you insure it or send it by a method that provides for tracking of the package. The repaired or replaced item will be shipped to you, at Icron Technologies Corporation's expense, not later than thirty days after Icron Technologies Corporation receives the defective product.

Address the returned product to:

RMA Coordinator
Icron Technologies Corporation
4664 Lougheed Highway, Suite 221
Burnaby, BC Canada
V5C 5T5

Contacting Sales

Email: sales@icron.com
Tel: +1 604 638 3920

Contacting Technical Support

icron.com/support
Tel: +1 604 638 3920

To help us serve you better, please include the following information with your technical support request:

- Host computer make and model
- Type of Operating System installed (e.g. Windows XP, 7, 8, Mac OS X, etc)
- Part number and serial number for both the LEX and REX
- Make and model of any USB device(s) attached to the product
- Description of the installation
- Description of the problem
- Description of the network (i.e.: number of switches, switch model names, switch speeds, etc)

Technical Glossary

Category 5e (Cat 5e) Network Cabling

Category 5e cable is commonly also referred to as Cat 5e. This cabling is available in either solid or stranded twisted pair copper wire variants and as UTP (Unshielded Twisted Pair) or STP (Shielded Twisted Pair). UTP cables are not surrounded by any shielding making them more susceptible to electromagnetic interference (EMI). STP cables include shielding the copper wires and provides better protection against ElectroMagnetic Interference (EMI).

USB 2.0 Cables

USB 2.0 cables have two distinct full-sized connectors. The Type A connector is used to connect the cable from a USB device to the Type A port on a computer or hub. The Type B connector is used to attach the USB cable to a USB device.

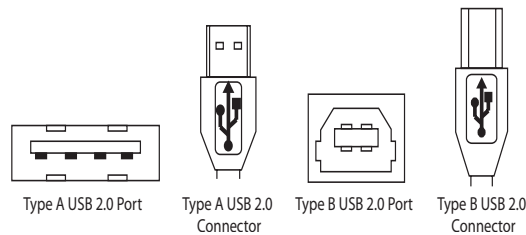

RJ45

The Registered Jack (RJ) physical interface is what connects the network cabling (Cat 5e) to the LEX unit and REX unit. You may use either the T568A scheme (Table 1) or the T568B scheme (Table 2) for cable termination as the USB 2.0 Ranger 2304 requires all four pairs of the cable. RJ45 connectors are sometimes also referred to as 8P8C connectors. Note that any given cable must be terminated using the same T568 scheme on both ends to operate correctly.

RJ45 Pin Positioning

Table 1 - T568A Wiring

PIN	PAIR	WIRE	CABLE COLOR
1	3	1	WHITE/GREEN
2	3	2	GREEN
3	2	1	WHITE/ORANGE
4	1	2	BLUE
5	1	1	WHITE/BLUE
6	2	2	ORANGE
7	4	1	WHITE/BROWN
8	4	2	BROWN

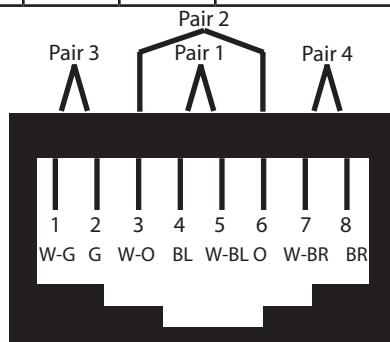
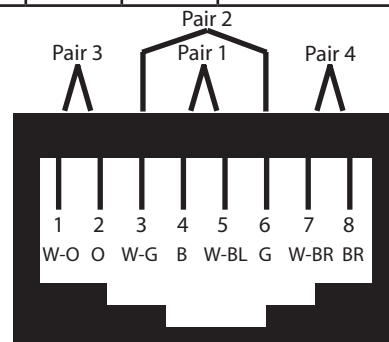

Table 2 - T568B Wiring

PIN	PAIR	WIRE	CABLE COLOR
1	2	1	WHITE/ORANGE
2	2	2	ORANGE
3	3	1	WHITE/GREEN
4	1	2	BLUE
5	1	1	WHITE/BLUE
6	3	2	GREEN
7	4	1	WHITE/BROWN
8	4	2	BROWN



Specifications

RANGE	
Direct Connect	Up to 100m (330 ft) over solid core Cat 5e or better
USB DEVICE SUPPORT	
Maximum USB 2.0 Throughput	Up to 480Mbps
Maximum USB 1.1 Throughput	Up to 12Mbps
Traffic Types	All USB 2.0 and 1.1 Traffic Types
Device Types	All USB 2.0 and 1.1 Device Types
Number of Devices and/or Hubs	17
LOCAL EXTENDER (LEX)	
USB Connector	1 x USB 2.0 Type B Receptacle
Link Connector	1 x RJ45
Dimensions	100mm x 76mm x 26mm (3.9" x 3.0" x 1.0")
Enclosure Material	Silver Anodized Aluminum
REMOTE EXTENDER (REX)	
USB Connectors	4 x USB 2.0 Type A Receptacles
Link Connector	1 x RJ45
Dimensions	100mm x 76mm x 26mm (3.9" x 3.0" x 1.0")
Enclosure Material	Silver Anodized Aluminum
Available Current	600mA at each USB port concurrently
Power Supply	100-240V AC input, 24V 1A DC Output
ENVIRONMENTAL	
Operating Temperature Range	0°C to 50°C (32°F to 122°F)
Storage Temperature Range	-10°C to 60°C (14°F to 140°F)
Operating Humidity	20% to 80% relative humidity, non-condensing
Storage Humidity	10% to 90% relative humidity, non-condensing
COMPLIANCE	
EMC	FCC (Class B), CE (Class B)
Environmental	RoHS2 (CE)
SUPPORT	
Warranty	2 years



Icron Technologies Corporation

4664 Lougheed Highway, Suite 221

Burnaby, BC Canada

V5C 5T5

Tel: +1 604 638 3920

Fax: +1 604 638 3930

icron.com