

PQ2Lxxx2MSPQ Series

2-Output Type
Low Power-Loss Voltage Regulators

Features

1. Compact surface mount package (4.5x4.3x1.5mm)
2. Each channel 250mA
Output 1: Voltage 3.3V / 2.5V
Output 2: Voltage 3.3V / 2.5V / 1.8V / 1.5V
3. Power dissipation : MAX.900mW
(At surface-mounted condition)
4. Low power-loss
(Dropout voltage : MAX. 0.4V at $I_o=100mA$)
5. Use of ceramic capacitor is possible as output smooth capacitor
6. RoHS directive compliant

Applications

1. CD-ROM drives
2. DVD-ROM drives
3. Digital Still Cameras

Absolute Maximum Ratings

($T_a=25^\circ C$)

Parameter	Symbol	Rating	Unit
*1 Input voltage	V_{IN}	9	V
Output current	I_{o1}	250	mA
	I_{o2}	250	
*2 Power dissipation	P_D	900	mW
*3 Junction temperature	T_j	150	$^\circ C$
Operating temperature	T_{opr}	-30 to +80	$^\circ C$
Storage temperature	T_{stg}	-55 to +150	$^\circ C$
Soldering temperature	T_{sol}	270(10s)	$^\circ C$

*1 All are open except GND and applicable terminals.
*2 At surface-mounted condition
*3 Overheat protection may operate at $T_j:125^\circ C$ to $150^\circ C$

Outline Dimensions

(Unit : mm)

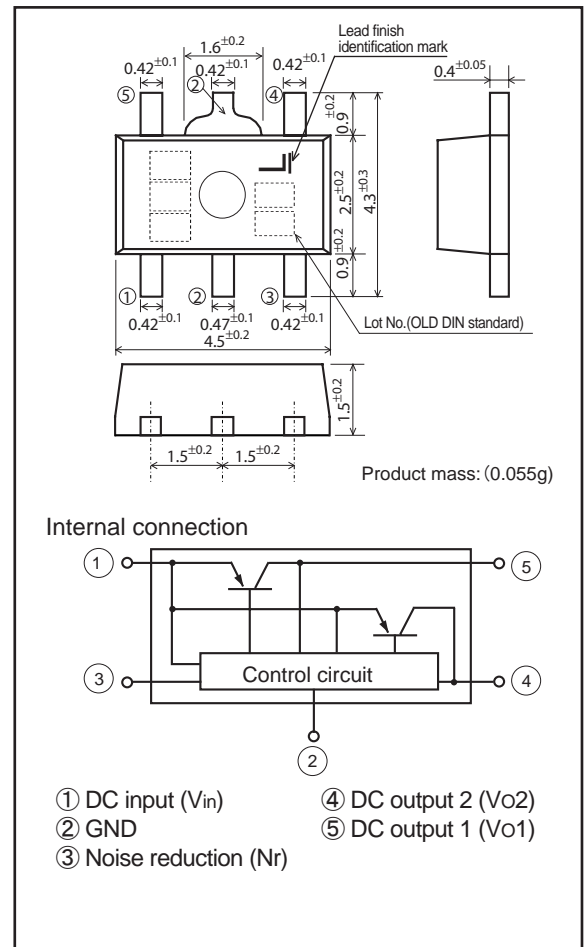

Lead finish: Lead-free solder plating
(Composition: Sn2Bi)

Notice The content of data sheet is subject to change without prior notice.

In the absence of confirmation by device specification sheets, SHARP takes no responsibility for any defects that may occur in equipment using any SHARP devices shown in catalogs, data books, etc. Contact SHARP in order to obtain the latest device specification sheets before using any SHARP device.

Electrical Characteristics

(Unless otherwise specified condition shall be $V_{in}=V_{o1}(TYP.)+1.0V$, $I_{o1}=0mA$, $I_{o2}=0mA$, $T_a=25^{\circ}C$)

Parameter	Symbol	Conditions	MIN.	TYP.	MAX.	Unit
Output voltage	V_o	-	Refer to list.1			V
Load regulation	RegL1	$I_{o1}=5$ to 200mA	-	30	160	mV
	RegL2	$I_{o2}=5$ to 200mA	-	30	160	
Line regulation	RegL1	$V_{in}=V_{o1}(TYP.)+1V$ to $V_{o1}(TYP.)+6V(MAX.9V)$, $I_{o1}=30mA$	-	3	20	mV
	RegL2	$V_{in}=V_{o2}(TYP.)+1V$ to $V_{o2}(TYP.)+6V(MAX.9V)$, $I_{o2}=30mA$	-	3	20	
Temperature coefficient of output voltage	TcVo1	$I_{o1}=10mA$, $T_j=-25$ to $75^{\circ}C$	-	0.1	-	mV/ $^{\circ}C$
	TcVo2	$I_{o2}=10mA$, $T_j=-25$ to $75^{\circ}C$	-	0.1	-	
*4 Ripple rejection	RR	Refer to Fig.2	-	60	-	dB
Output noise voltage	$V_{no(rms)}$	$10Hz < f < 100kHz$, $I_o=30mA$, $C_n=0.01\mu F$	-	50	-	μV
Dropout voltage	V_{I-o1}	$I_{o1}=100mA$, *5	-	0.16	0.4	V
	V_{I-o2}	$I_{o2}=200mA$, *5	-	0.24	1.0	
Quiescent current	I_q	-	-	250	400	μA

*4 Typical value of 3.3V output model.

*5 Input voltage when output voltage falls 0.1V from that at $V_{in}=V_o(TYP.)+1.0V$.
However, $V_{in} \geq 2.3V$.

List.1 Output voltage

($V_{in}=V_{o1}(TYP.)+1.0V$, $T_a=25^{\circ}C$)

Parameter	Model No.	Symbol	Conditions	MIN.	TYP.	MAX.	Unit
Output voltage	PQ2L3332MSPQ	V_{o1}	$I_{o1}=30mA$, $I_{o2}=0mA$	3.234	3.3	3.366	V
		V_{o2}	$I_{o1}=0mA$, $I_{o2}=30mA$	3.234	3.3	3.366	
	PQ2L3252MSPQ	V_{o1}	$I_{o1}=30mA$, $I_{o2}=0mA$	3.234	3.3	3.366	
		V_{o2}	$I_{o1}=0mA$, $I_{o2}=30mA$	2.440	2.5	2.560	
	PQ2L3182MSPQ	V_{o1}	$I_{o1}=30mA$, $I_{o2}=0mA$	3.234	3.3	3.366	
		V_{o2}	$I_{o1}=0mA$, $I_{o2}=30mA$	1.740	1.8	1.860	
	PQ2L3152MSPQ	V_{o1}	$I_{o1}=30mA$, $I_{o2}=0mA$	3.234	3.3	3.366	
		V_{o2}	$I_{o1}=0mA$, $I_{o2}=30mA$	1.440	1.5	1.560	
	PQ2L2182MSPQ	V_{o1}	$I_{o1}=30mA$, $I_{o2}=0mA$	2.440	2.5	2.560	
		V_{o2}	$I_{o1}=0mA$, $I_{o2}=30mA$	1.740	1.8	1.860	
	PQ2L2152MSPQ	V_{o1}	$I_{o1}=30mA$, $I_{o2}=0mA$	2.440	2.5	2.560	
		V_{o2}	$I_{o1}=0mA$, $I_{o2}=30mA$	1.440	1.5	1.560	

Fig.1 Standard measuring circuit of Regulator portion

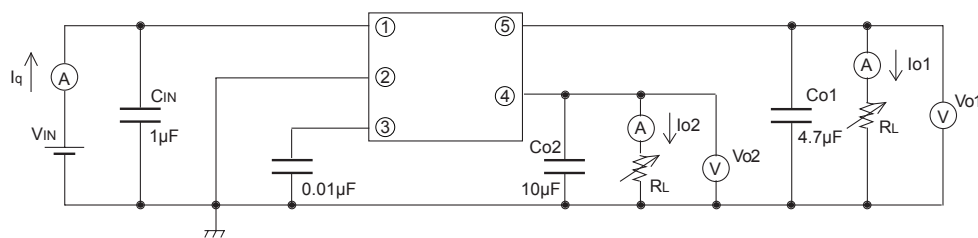
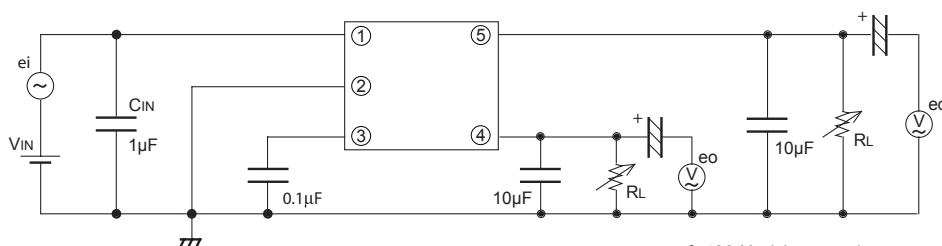
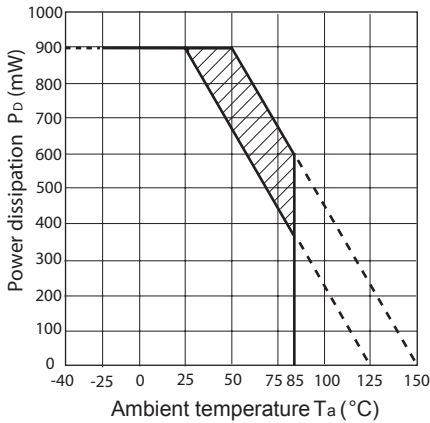

Fig.2 Standard measuring circuit of critical rate of ripple rejection



$f=400$ Hz (sine wave)
 $e_i(rms)=100$ mV
 $V_{in}=V_{o}(TYP.)+1.0V$
 $I_o=10mA$
 $RR=20\log(e_i(rms)/e_o(rms))$

Fig.3 Power Dissipation vs. Ambient Temperature



Note) Oblique line portion: Overheat protection may operate in this area.

Mounting PCB

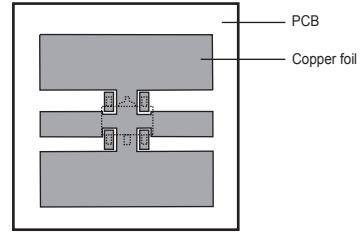

Material : Glass-cloth epoxy resin
 PCB Size : 20×20×1.0mm
 Copper foil area : 180mm²
 Thickness of copper : 35μm

Fig.4 Overcurrent Protection Characteristics (Typical Value)

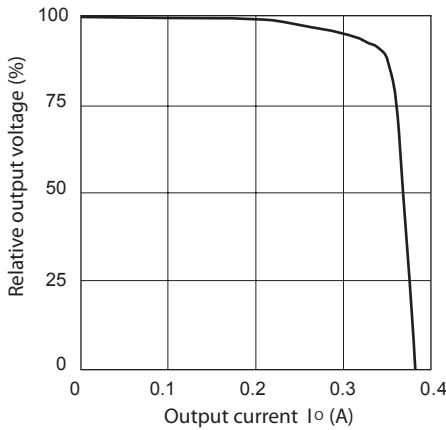

Fig.5 Reference Voltage Deviation vs. Junction Temperature (PQ2L3252MSPQ)(Typical Value)

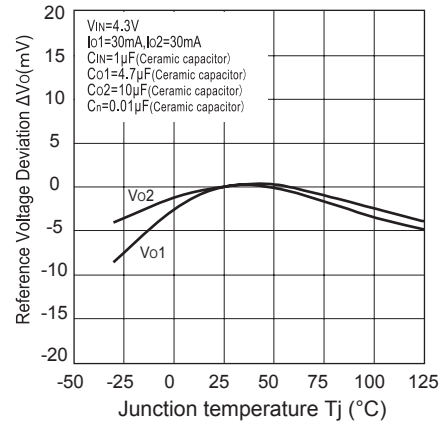

Fig.6 Output Voltage(Vo1) vs. Input Voltage (PQ2L3152MSPQ)(Typical Value)

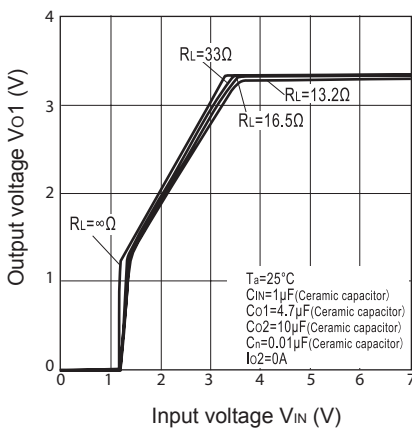

Fig.7 Output Voltage(Vo2) vs. Input Voltage (PQ2L3152MSPQ)(Typical Value)

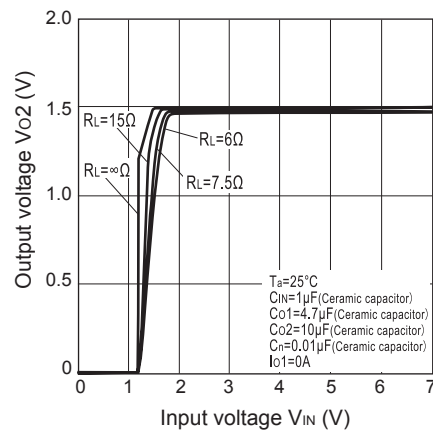

Fig.8 Circuit Operating Current vs. Input Voltage (PQ2L3152MSPQ)(Typical Value)

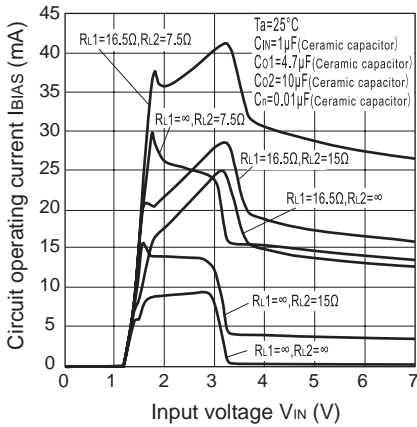

Fig.9 Dropout Voltage vs. Junction Temperature (PQ2L3252MSPQ)(Typical Value)

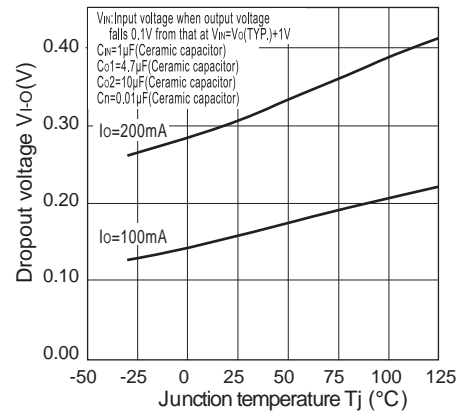

Fig.10 Quiescent Current vs. Junction Temperature (PQ2L3252MSPQ)(Typical Value)

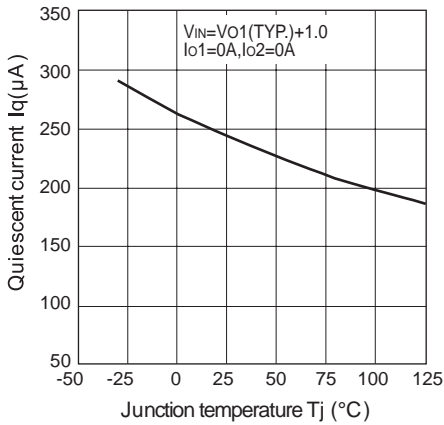

Fig.11 Ripple Rejection vs. Input Ripple Frequency (PQ2L3182MSPQ)(Typical Value)

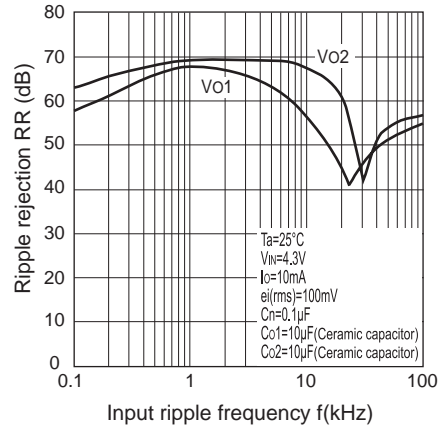

Fig.12 Dropout Voltage vs. Output Current (Typical Value)

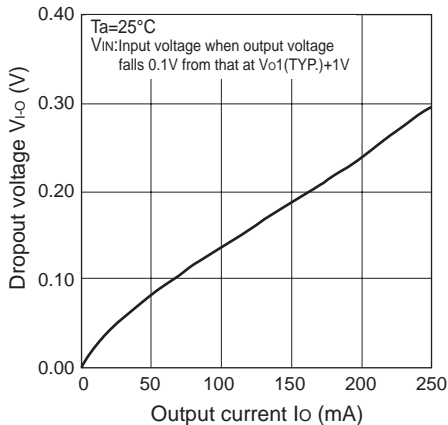

Fig.13 Output Peak Current vs. Junction Temperature (Typical Value)

