

SATU-O

~40° + 20° oval beam optimized for CREE XT-E

TECHNICAL SPECIFICATIONS:

Dimensions	Ø 21.8 mm
Height	8.9 mm
Fastening	glue, pin
Colour	clear
Box size	480 x 280 x 300 mm
Box weight	7.7 kg
Quantity in Box	2880 pcs
ROHS compliant	yes ⓘ



MATERIAL SPECIFICATIONS:

Component	Type	Material	Colour
SATU-O	Lens array	PMMA	clear

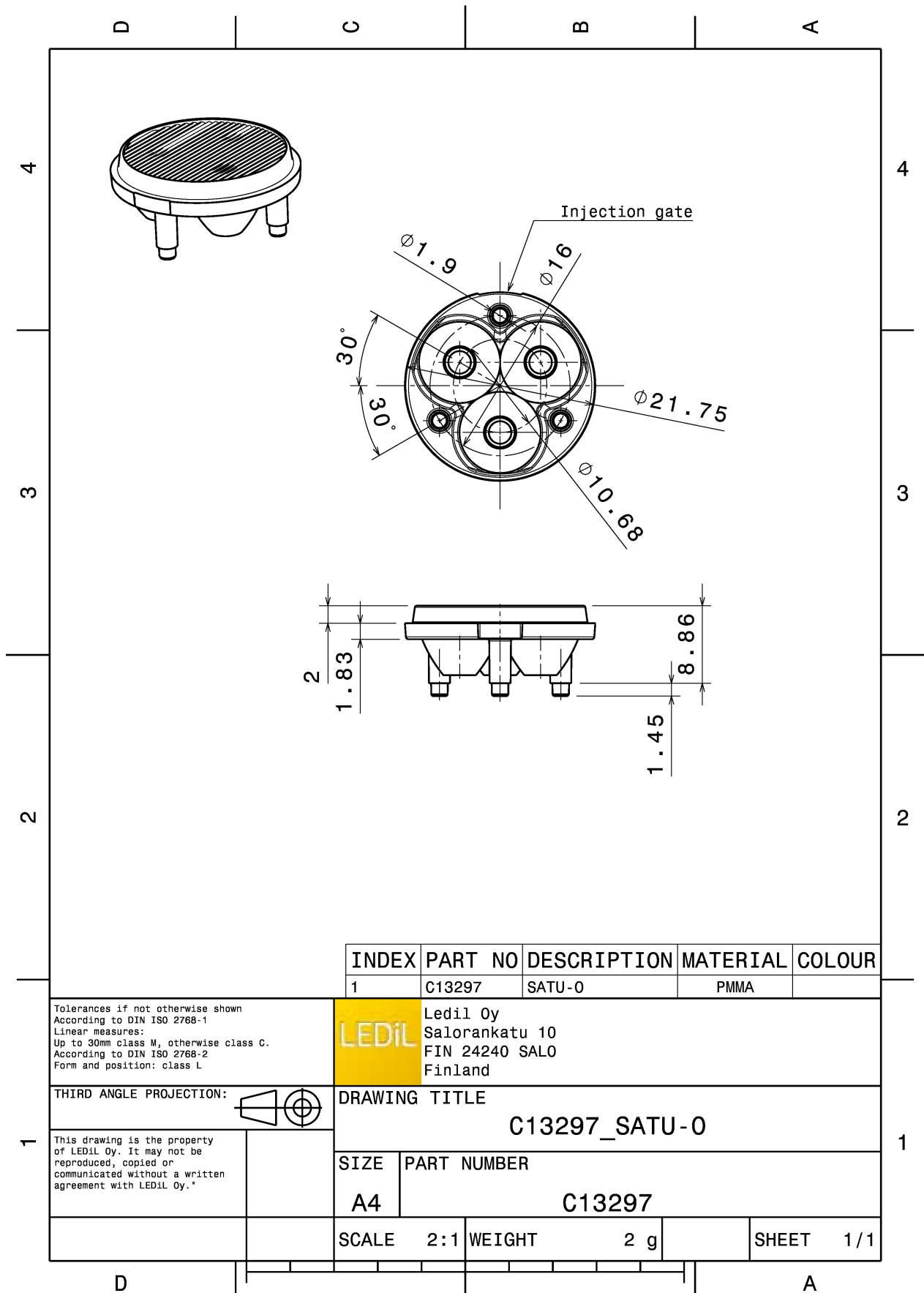

PHOTOMETRIC DATA (MEASURED):

CREE

LED XB-D
FWHM 42.0 + 22.0°
Efficiency 77 %
Peak intensity 2.000 cd/lm
Required components:



CREE

LED XP-E
FWHM 41.0 + 17.0°
Efficiency 83 %
Peak intensity 2.900 cd/lm
Required components:

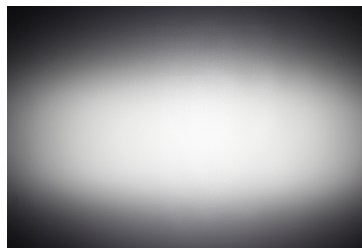

CREE

LED XP-E2
FWHM 40.0 + 17.0°
Efficiency 85 %
Peak intensity 3.000 cd/lm
Required components:

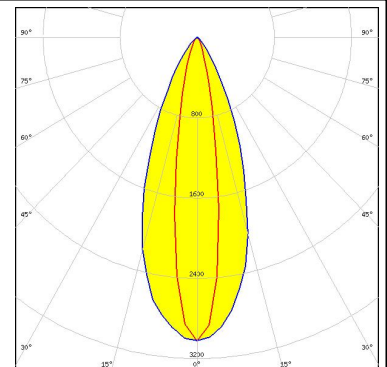
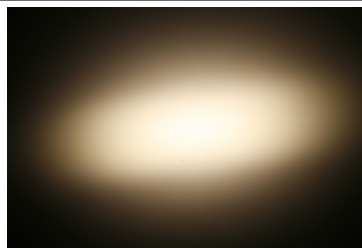

CREE

LED XP-G
FWHM 39.0 + 23.0°
Efficiency 79 %
Peak intensity 2.200 cd/lm
Required components:

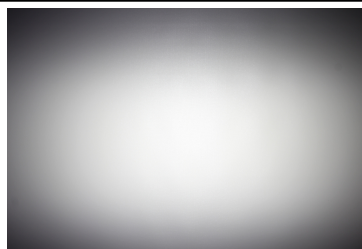

PHOTOMETRIC DATA (MEASURED):



LED XP-G2
 FWHM 39.0 + 24.0°
 Efficiency 84 %
 Peak intensity 2.200 cd/lm
 Required components:

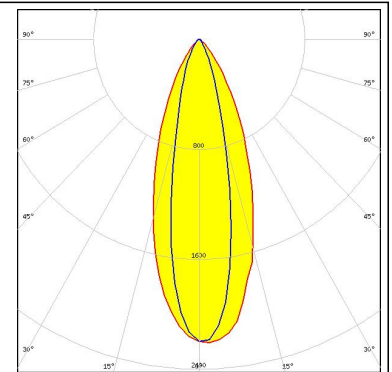

LED H35B0 (LEMWA32)
 FWHM 39.0 + 24.0°
 Efficiency 84 %
 Peak intensity 2.200 cd/lm
 Required components:

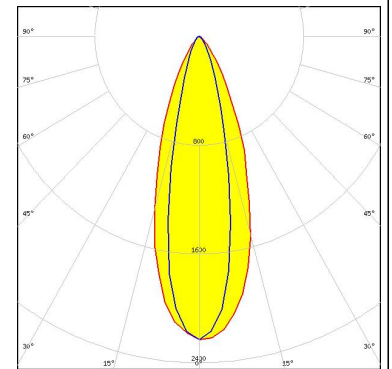
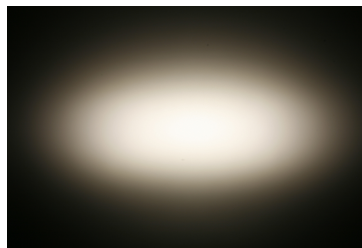

LED H35C0 (LEMWA33)
 FWHM 39.0 + 25.0°
 Efficiency 82 %
 Peak intensity 2.000 cd/lm
 Required components:

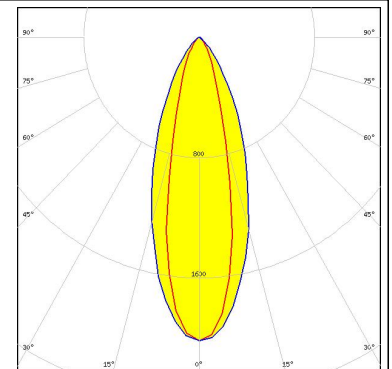
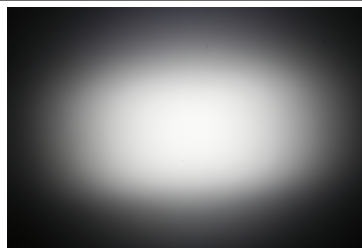

LED LUXEON T
 FWHM 40.0 + 24.0°
 Efficiency 84 %
 Peak intensity 2.000 cd/lm
 Required components:

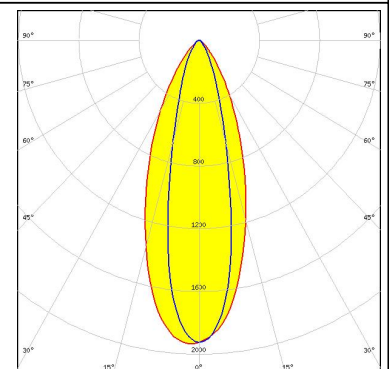
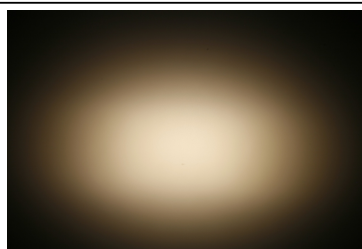

PHOTOMETRIC DATA (MEASURED):



LED LUXEON TX
 FWHM 40.0 + 25.0°
 Efficiency 79 %
 Peak intensity 1.900 cd/lm
 Required components:

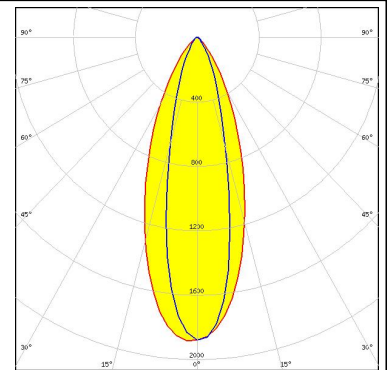

LED NF2x757A
 FWHM 43.0 + 26.0°
 Efficiency 81 %
 Peak intensity 1.500 cd/lm
 Required components:

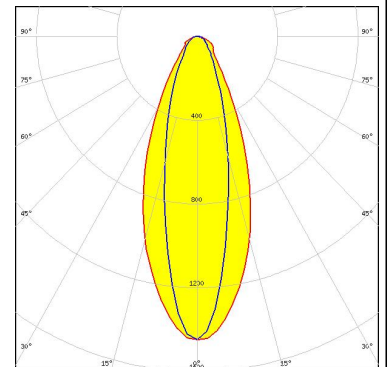
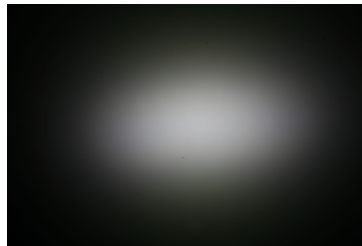

LED Oslon Square EC
 FWHM 41.0 + 23.0°
 Efficiency 82 %
 Peak intensity 2.000 cd/lm
 Required components:

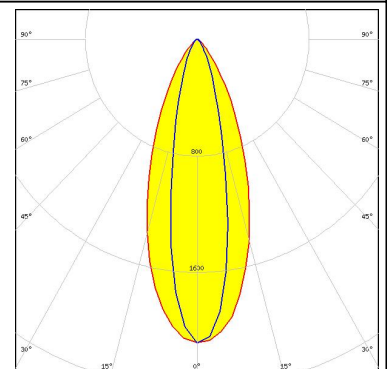
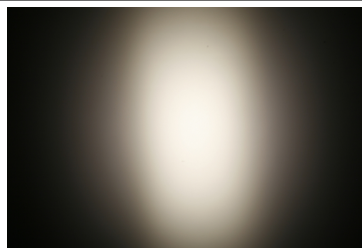

LED Oslon SSL 80
 FWHM 41.0 + 18.0°
 Efficiency 79 %
 Peak intensity 2.500 cd/lm
 Required components:

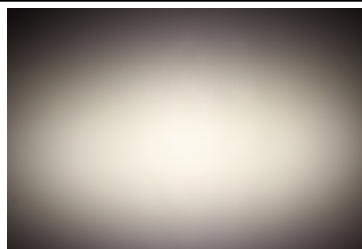

PHOTOMETRIC DATA (MEASURED):

SAMSUNG

LED LH351Z
FWHM 40.0 + 23.0°
Efficiency 84 %
Peak intensity 2.300 cd/lm
Required components:

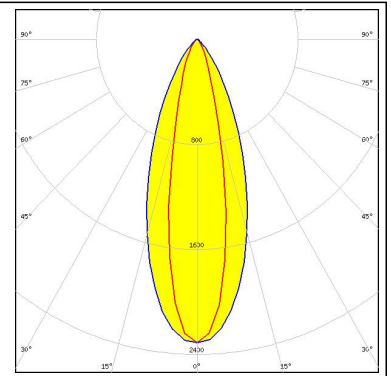

PHOTOMETRIC DATA (SIMULATED):



LED XT-E
FWHM 20.0 + 40.0°
Efficiency %
Peak intensity cd/lm
Required components:

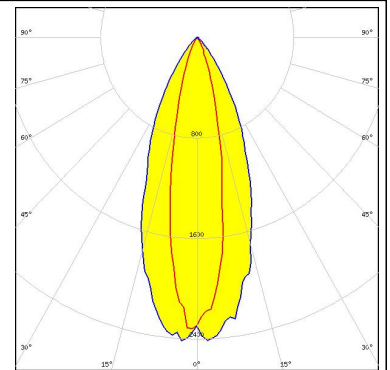

LED LUXEON H50-2
FWHM 22.0 + 42.0°
Efficiency 85 %
Peak intensity 2.000 cd/lm
Required components:

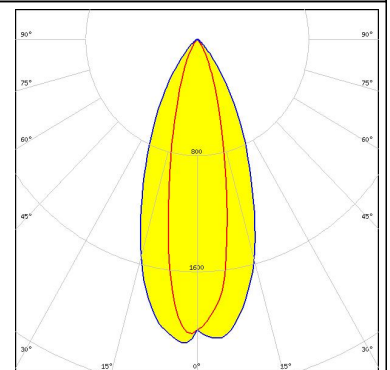

LED NVSxx19B/NVSxx19C
FWHM 43.0 + 24.0°
Efficiency 82 %
Peak intensity 1.950 cd/lm
Required components:

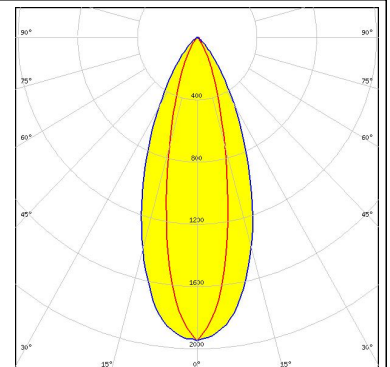

LED Synios P2720 1/2 mm
FWHM 25.0 + 12.0°
Efficiency 91 %
Peak intensity 3.450 cd/lm
Required components:

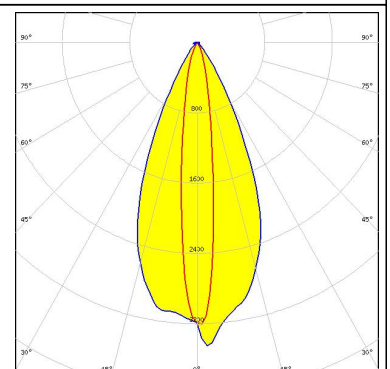

PHOTOMETRIC DATA (SIMULATED):

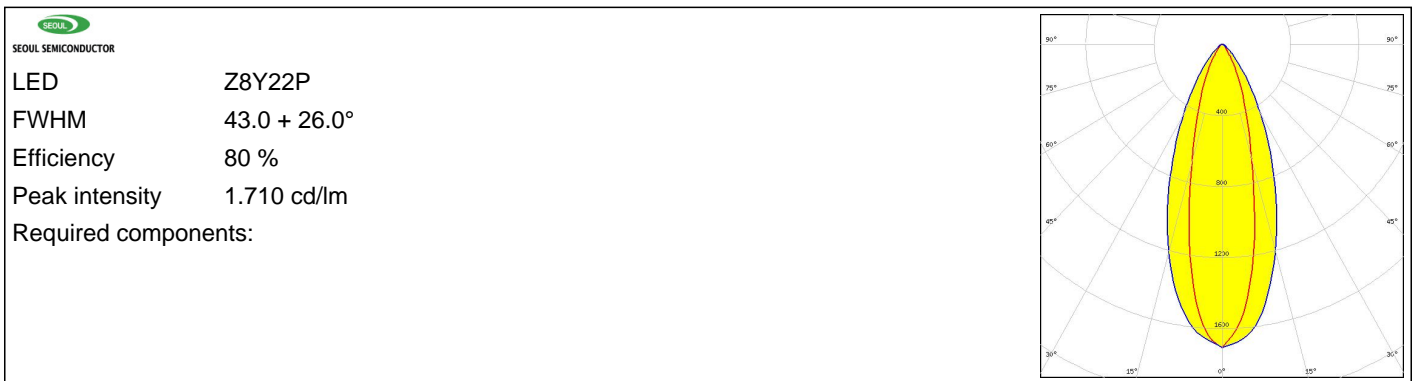

GENERAL INFORMATION:

NOTE: The typical beam angle will be changed by different color, chip size and chip position tolerance. The typical total beam angle is the full angle measured where the luminous intensity is half of the peak value.

MATERIALS:

As part of our continuous research and improvement processes, and to ensure the best possible quality and availability of our products, LEDiL reserves the right to change material grades without notice.

PRODUCT DATA USER AGREEMENT AND DISCLAIMER:

The measured data in the provided downloadable LEDiL Product Datasheets and Mechanical 2D-Drawings is rounded and provided as reference for planning. LEDiL Oy's optical specifications have been verified by conducting performance testing of the products in accordance with the company's quality system. The reported data are averaged results of multiple measurements with typical variation. LEDiL Oy reserves the right to without prior notification make changes and improvements to its products.

LEDiL Oy assumes neither warranty, nor guarantee nor any other liability of any kind for the contents and correctness of the provided data. The provided data has been generated with highest diligence but the provided data may in reality not represent the complete possible variation range of all intrinsic parameters. Therefore, in certain cases a deviation from the provided data could occur.

LEDiL Oy reserves the right to undertake technical changes of its products without further notification which could lead to changes in the provided data. LEDiL Oy assumes no liability of any kind for the possible deviation from any provided data or any other damage resulting from the usage of the provided data.

The user agrees to this disclaimer and user agreement with the download or usage of the provided files.

LEDiL Oy

Joensuunkatu 13
FI-24240 SALO
Finland

LEDiL Inc.

228 West Page Street
Suite D
Sycamore IL 60178
USA

Local sales and technical support

[www.ledil.com/
where_to_buy](http://www.ledil.com/where_to_buy)

Shipping locations

Salo, Finland
Hong Kong, China

Distribution Partners

[www.ledil.com/
where_to_buy](http://www.ledil.com/where_to_buy)