



Features

- RoHS compliant*
- Push-pull switch
- Linear and audio tapers
- PC board and bushing mount
- Splash seal
- Metal bushing and shaft

Applications

- Test and measurement equipment
- Communications equipment
- Medical diagnostic equipment
- Professional audio equipment

54 - 1/2 " (12.5 mm) Panel Control w/Push-Pull Switch

Electrical Characteristics¹

Standard Resistance Range	
Linear.....	1K to 500K ohms
Audio.....	1K to 500K ohms
Total Resistance Tolerance	
B & D Tapers.....	±20 %
E & S Tapers.....	±10 %
Independent Linearity.....	±5 %
Absolute Minimum Resistance.....	2 ohms maximum
Effective Electrical Angle.....	270 ° ±5
Contact Resistance Variation.....	±2 %
Dielectric Withstanding Voltage (MIL-STD-202 – Method 301)	
Sea Level.....	1,500 VAC minimum
70,000.....	500 VAC minimum
Insulation Resistance.....	1,000 megohms minimum
Power Rating At 70 °C (Derate To 0 At 125 °C)	
(Voltage Limited By Power Dissipation or 350 VAC, Whichever Is Less)	
Linear Tapers.....	0.5 watt
Audio Tapers.....	0.25 watt
Theoretical Resolution.....	Essentially infinite

Environmental Characteristics¹

Operating Temperature Range.....	+1 °C to +125 °C
Storage Temperature Range.....	-55 °C to +125 °C
Temperature Coefficient Over Storage Temperature Range.....	±1,000 ppm/°C
Vibration.....	8 G
Total Resistance Shift.....	±2 % maximum
Voltage Ratio Shift.....	±5 % maximum
Shock.....	20 G
Total Resistance Shift.....	+2 % maximum
Voltage Ratio Shift.....	±5 % maximum
Load Life.....	1,000 hours
Total Resistance Shift.....	±10 % TRS maximum
Rotational Life (No Load).....	50,000 cycles
Total Resistance Shift.....	±10 % TRS maximum
Contact Resistance Variation.....	±2 %
Moisture Resistance (MIL-STD-202, Method 103, Condition B)	
B & E.....	±10 % TRS
D & S.....	±20 % TRS
IP Rating	
Entire Unit.....	IP64
Shaft/Bushing.....	IP65

Mechanical Characteristics

Stop Strength.....	39.5 N-cm (3.5 lb.-in.)
Mechanical Angle.....	290 ° ±5 °
Torque	
Starting/Running.....	0.2 to 1.3 N-cm (0.25 to 2.0 oz.-in.)
Mounting (Torque on Bushing).....	1.7 to 2.0 N-m (15 to 18 lb.-in.)
Weight.....	10 grams
Terminals.....	PC pin or solder lug
Soldering Condition.....	Recommended hand soldering using Sn95/Ag5 no clean solder, 0.025 " wire diameter. Maximum temperature 399 °C (750 °F) for 3 seconds. No wash process to be used with no clean flux. Part can be wave soldered at 260 °C (500 °F) for 5 seconds, no wash process with no clean flux.
Marking.....	Manufacturer's trademark, part number, resistance value and date code.
Ganging (Multiple Section Potentiometers).....	Inquire for availability, minimum order quantity and price.
Hardware.....	One lockwasher and one mounting nut is shipped with each potentiometer.

¹At room ambient: +25 °C nominal and 50 % relative humidity nominal, except as noted.

54 - 1/2 " (12.5 mm) Panel Control w/Push-Pull Switch

BOURNS®

Initial Electrical Characteristics - Switch

Switch Type	DPDT (Break before make)
Power Rating (Resistive Load)	0.25 A @ 30 VDC
Dielectric Withstanding Voltage (MIL-STD-202, Method 301) Sea Level	1000 VAC minimum
Insulation Resistance	1500 megohms minimum
Contact Resistance	100 milliohms maximum
Actuating Stroke	0.41 cm (0.16 in.) maximum

Environmental Characteristics¹

Vibration	8 G
Contact Resistance	100 milliohms maximum
Contact Bounce	0.1 milliseconds maximum
Shock	20 G
Contact Resistance	100 milliohms maximum
Contact Bounce	0.1 milliseconds maximum
Switch Life @ Rated Power	15,000 actuations
Switch Actuating Force	0.45 kg (1.0 lb) minimum
Contact Resistance	100 milliohms maximum
Moisture Resistance (MIL-STD-202, Method 103, Condition B) Contact Resistance	100 milliohms maximum
Insulation Resistance (After 24 Hours @ Room Temperature - 500 VDC)	100 megohms minimum

¹At room ambient: +25 °C nominal and 50 % relative humidity nominal, except as noted.

Switch Configurations (Shown in Pulled Position)

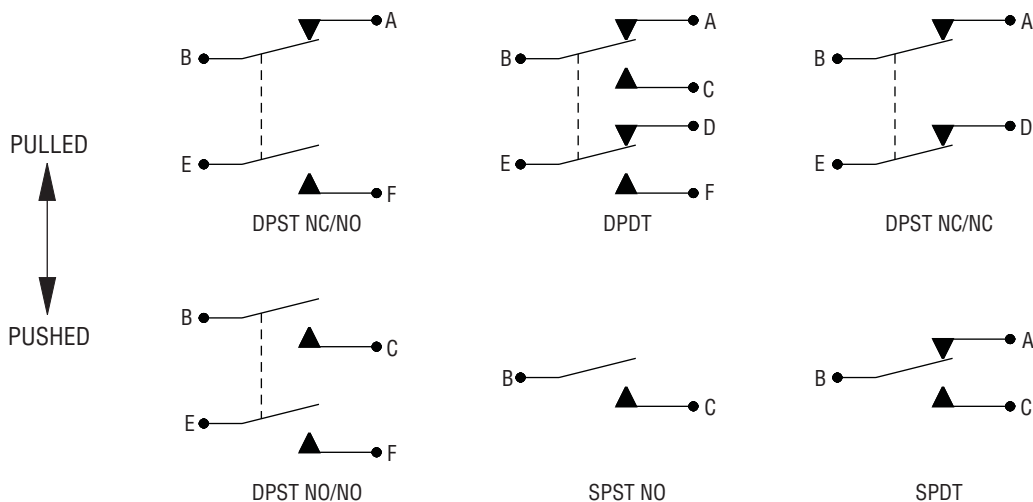

54 - 1/2" (12.5 mm) Panel Control w/Push-Pull Switch



Product Dimensions

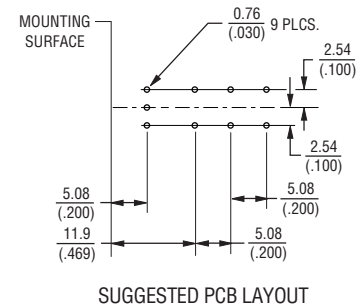
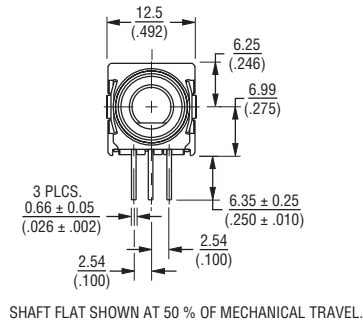
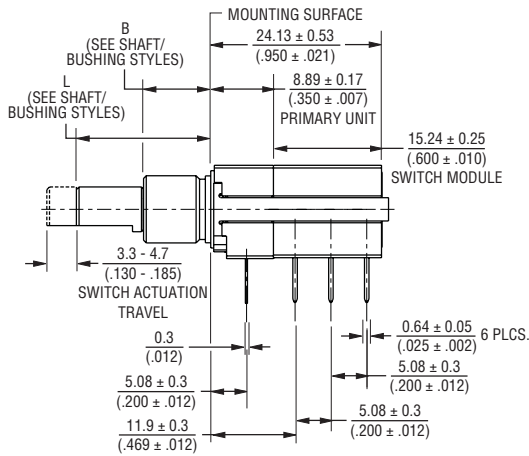

PACKAGE DIMENSIONS WITH FRONT AND REAR PCB MOUNTING BRACKET

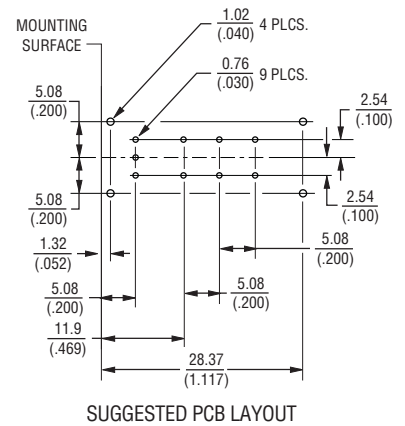
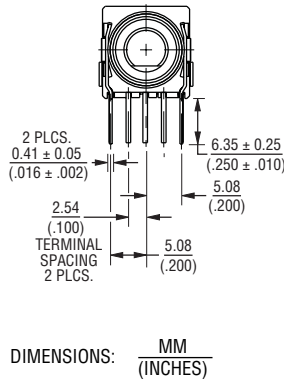
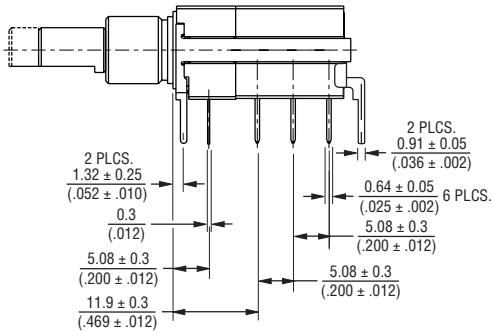

Anti-Rotation Lug

(Style "A", 90° CW Shown)

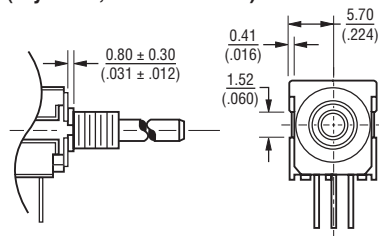

FOR TOLERANCES SHOWN: .XX ± $\frac{.25}{.010}$
 .XXX ± $\frac{.13}{.005}$
 SHAFT DIMENSIONS ± $\frac{.80}{(1/32)}$

Terminal Layout

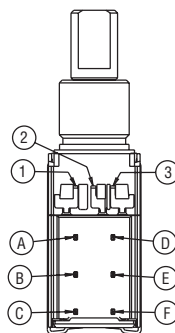

Electrical Schematic

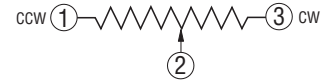

Suggested Panel Layouts

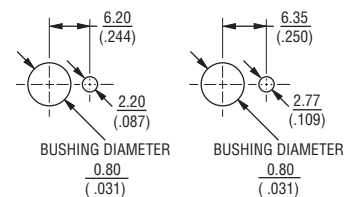

The Model 54 can be used with either of the two panel layouts shown below.

54 - 1/2" (12.5 mm) Panel Control w/Push-Pull Switch



Shaft/Bushing Styles

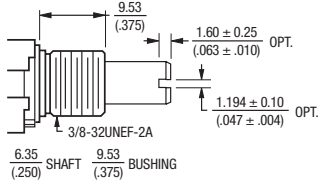

A Style Bushing

STD. LENGTH 'L'	
.750	(19.05)
.875	(22.23)

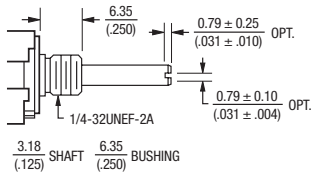

C Style Bushing

STD. LENGTH 'L'	
.750	(19.05)
.875	(22.23)

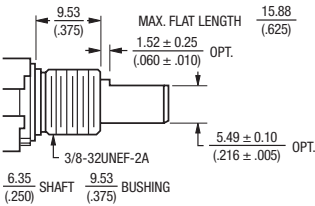

A Style Bushing - Flatted Shaft

STD. LENGTH 'L'	
.750	(19.05)
.875	(22.23)

DIMENSIONS: $\frac{\text{MM}}{\text{(INCHES)}}$

How To Order

54 A A D - C 28 - B 15 / P50 L

ANTI-ROTATION LUG / BRACKET OPTION	
Code	Description
A	AR Lug 90° CW
D	No AR Lug or Bracket
L	Front Bracket
N	Front and Rear Bracket

RoHS IDENTIFIER	
Code	Description
L	Compliant

SWITCH OPTION	
Code	Description
P50	DPDT

NO. OF SECTIONS	
Code	Description
A	Single plus Switch

RESISTANCE CODES	
Code	Value in Ohms
10	1K
13	5K
15	10K
18	50K
20	100K
22	250K
23	500K

BUSHING DESIGNATOR	
Code	Description
A	3/8" D x 3/8" L Threaded
C	1/4" D x 1/4" L Threaded

MODEL	
Code	Description
54	PC Terminals w/Push-Pull Switch

ELEMENT TAPER TYPE/TOLERANCE	
Code	Description
B	Linear CP ±20 %
E	Linear CP ±10 %
D	CW Audio CP ±20 %
S	CW Audio CP ±10 %

SHAFT LENGTH DESIGNATOR	
Code	Description
24	3/4" FMS Long
28	7/8" FMS Long

SHAFT STYLE		AVAILABLE ONLY WITH BUSHING
Code	Description	Code
B	1/4" D Slotted End	A
C	1/4" D Flatted End	A
E	1/8" D Slotted End	C

Boldface features are Bourns standard options. All others are available with higher minimum order quantities.



Asia-Pacific: Tel: +886-2 2562-4117 • Fax: +886-2 2562-4116

Europe: Tel: +41-41 768 5555 • Fax: +41-41 768 5510

The Americas: Tel: +1-951 781-5500 • Fax: +1-951 781-5700

www.bourns.com