



Pb-free  
HEAT



# AN5307B

Through-hole IRED/ $\phi$ 5 Type

## Features

Package	$\phi$ 5 type, Water clear epoxy
Product features	<ul style="list-style-type: none"><li>• Wide Distribution</li><li>• Lead-free soldering compatible</li><li>• RoHS compliant</li></ul>
Peak Wavelength	940nm
Half Intensity Angle	38 deg.
Die materials	GaAs
Rank grouping parameter	Sorted by radiant intensity per rank taping
Soldering methods	TTW (Through The Wave) soldering and manual soldering ※Please refer to Soldering Conditions about soldering.
ESD	2kV (HBM)
Packing	Bulk : 200pcs(MIN.)

## Recommended Applications

Electric Household Appliances, OA/FA, PC/Peripheral Equipment, Other General Applications

## Absolute Maximum Ratings

(Ta=25°C)

Item	Symbol	Absolute Maximum Ratings	Unit
Power Dissipation	Pd	160	mW
Forward Current	I <sub>F</sub>	100	mA
Pulse Forward Current ※1	I <sub>FRM</sub>	1,000	mA
Derating (Ta=25°C or higher)	ΔI <sub>F</sub>	1.33	mA/°C
	ΔI <sub>FRM</sub>	13.3	mA/°C
Reverse Voltage	V <sub>R</sub>	5	V
Operating Temperature	T <sub>opr</sub>	-30~+85	°C
Storage Temperature	T <sub>stg</sub>	-30~+100	°C

 ※1 I<sub>FRM</sub> Measurement condition : Pulse Width ≤ 0.1ms, Duty ≤ 1/100

## Electro-Optical Characteristics

(Ta=25°C)

Item	Conditions	Symbol	Characteristics		Unit
			MIN.	TYP.	
Forward Voltage	I <sub>F</sub> =50mA	V <sub>F</sub>	MIN.	1.15	V
			TYP.	1.3	
			MAX.	1.45	
Reverse Current	V <sub>R</sub> =5V	I <sub>R</sub>	MAX.	10	μA
Radiant Intensity	I <sub>F</sub> =50mA	I <sub>E</sub>	MIN.	8.4	mW/sr
			TYP.	19	
Total Output Power	I <sub>F</sub> =50mA	P <sub>o</sub>	TYP.	17	mW
Peak Wavelength	I <sub>F</sub> =50mA	λ <sub>p</sub>	TYP.	940	nm
Spectral Half-width	I <sub>F</sub> =50mA	Δλ	TYP.	50	nm
Half Intensity Angle	I <sub>F</sub> =50mA	2θ <sub>1/2</sub>	TYP.	38	deg.
Response Time	I <sub>F</sub> =50mA	tr/tf	TYP.	1/1	μs

**Radiant Intensity Rank**

(Ta=25°C)

Rank	I <sub>E</sub> (mW/sr)		Condition
	MIN.	MAX.	
<b>A</b>	<b>8.4</b>	<b>16.8</b>	<b>I<sub>F</sub> = 50mA</b>
<b>B</b>	<b>12.0</b>	<b>24.0</b>	
<b>C</b>	<b>16.8</b>	<b>33.6</b>	
<b>D</b>	<b>24.0</b>	<b>48.0</b>	
<b>E</b>	<b>33.6</b>	<b>67.2</b>	

※Please contact our sales staff concerning rank designation.

## Technical Data

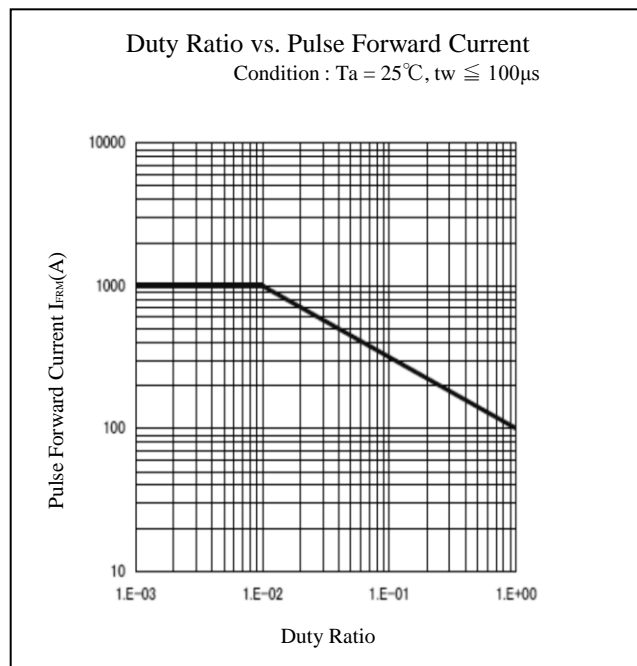
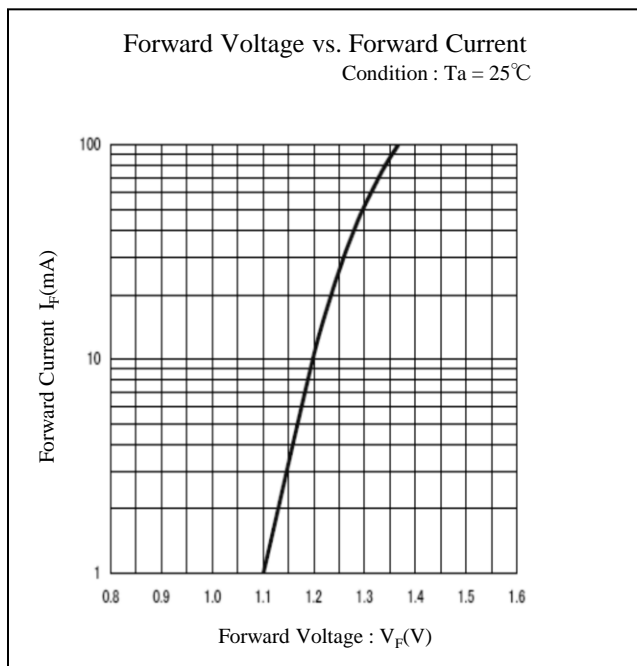
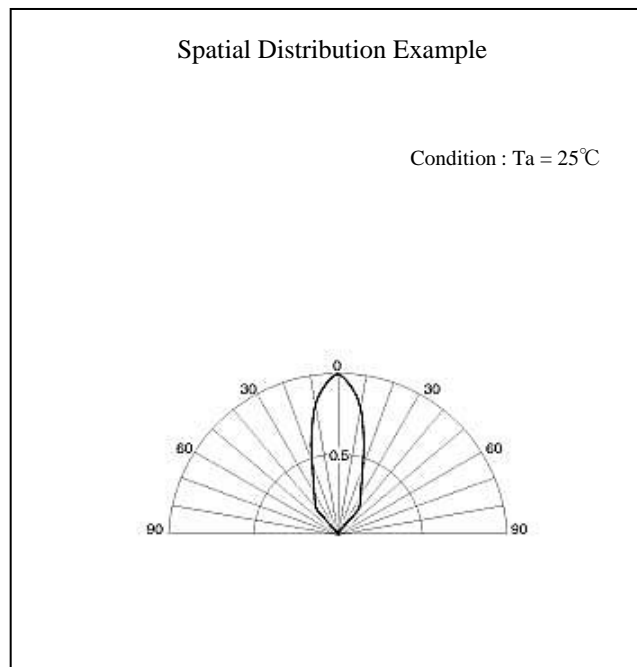
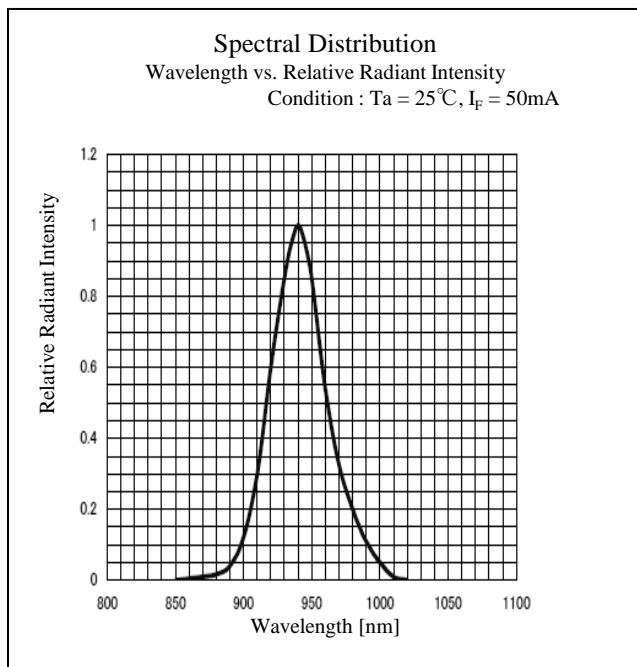

## Technical Data

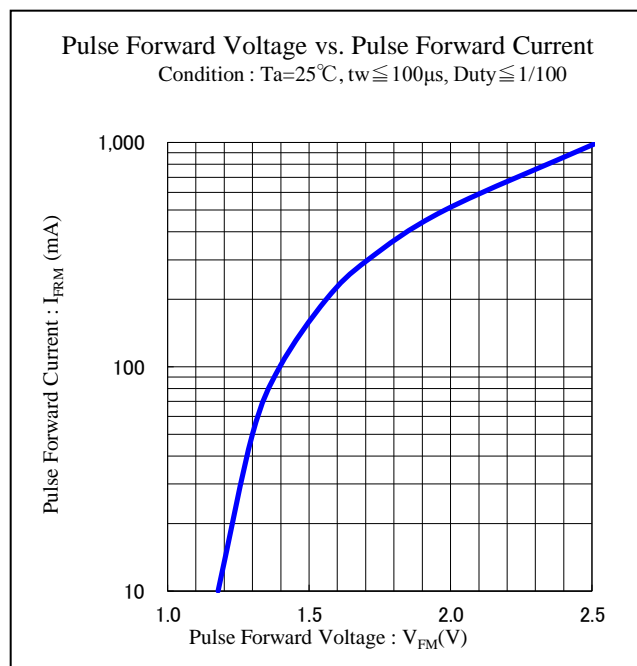
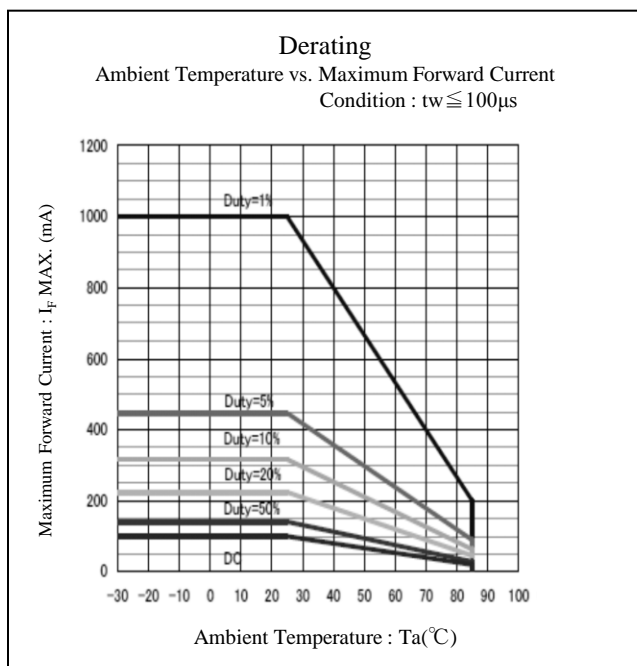
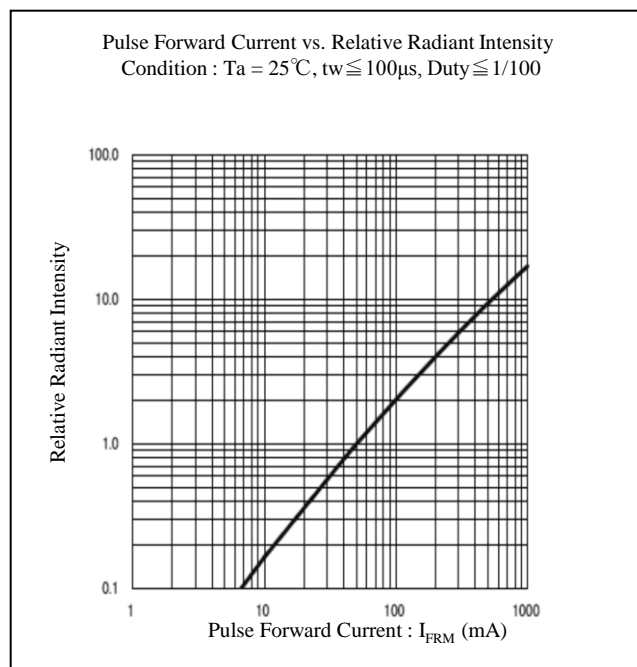
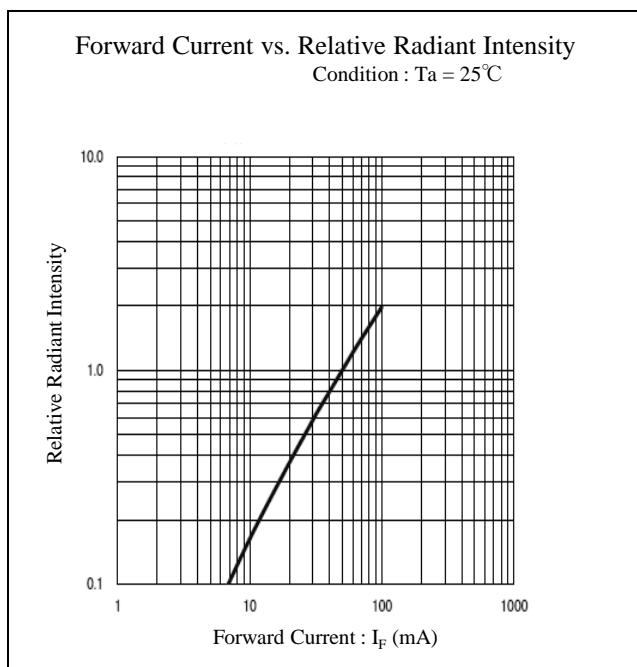

## Technical Data

Ambient Temperature vs. Forward Current

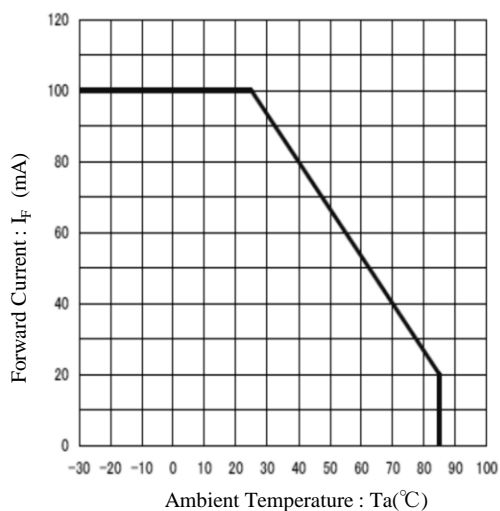

Pulse Forward Current vs. Ambient Temperature  
Condition :  $t_w \leq 100\mu s$ , Duty  $\leq 1/100$

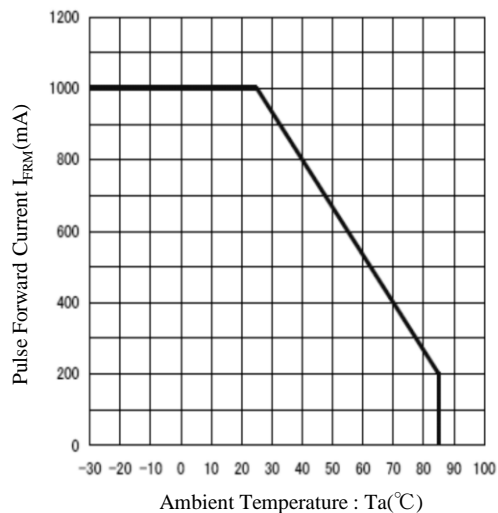

Ambient Temperature vs. Forward Voltage  
Condition : I<sub>F</sub> = 50mA

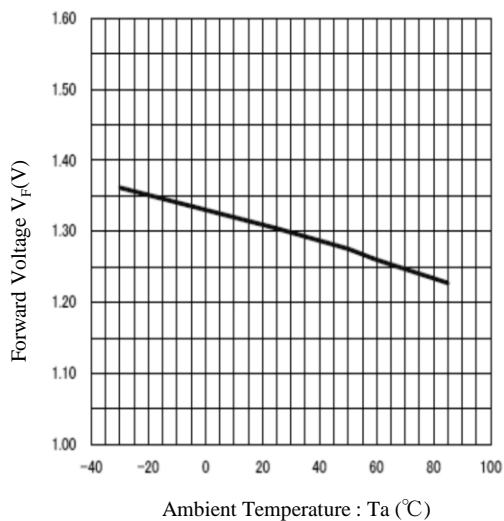

Ambient Temperature vs. Pulse Forward Voltage  
Condition : I<sub>FRM</sub> = 500mA,  $t_w \leq 100\mu s$ , Duty  $\leq 1/100$

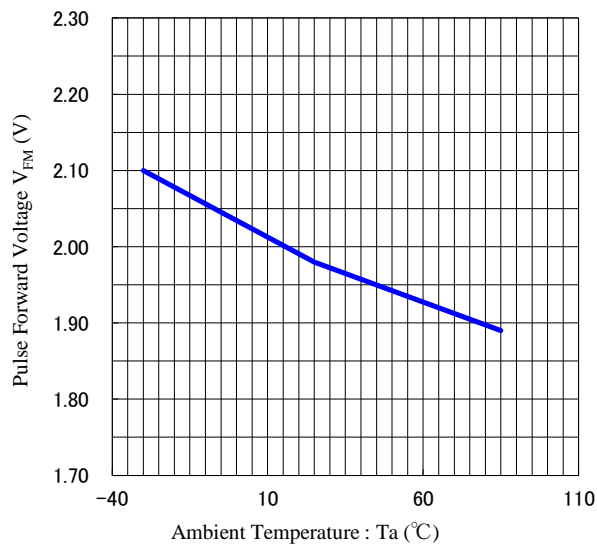

## Technical Data

Ambient Temperature vs. Peak Wavelength  
Condition :  $I_f = 50\text{mA}$

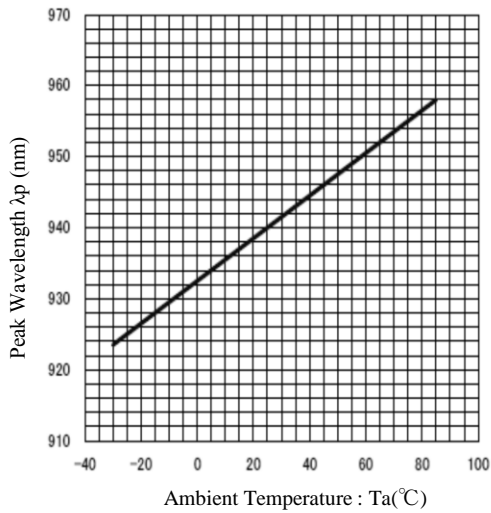

Ambient Temperature vs. Power Dissipation

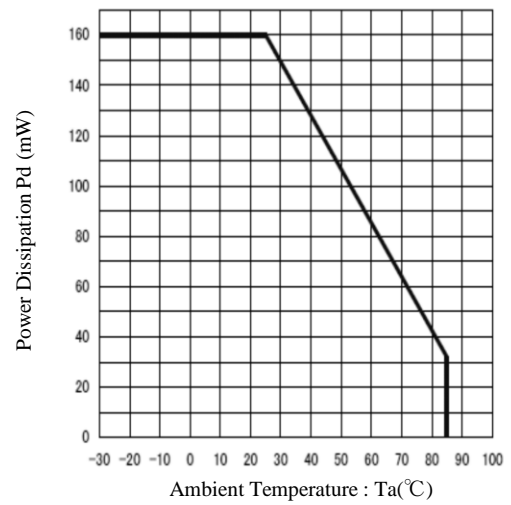

Ambient Temperature vs. Relative Radiant Intensity  
Condition :  $I_f = 50\text{mA}$

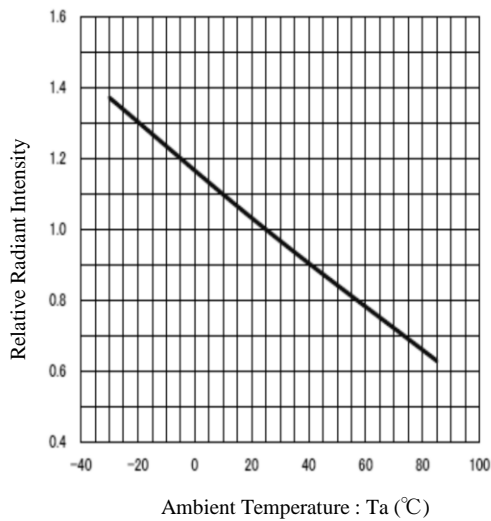

Package Dimensions

(Unit: mm)

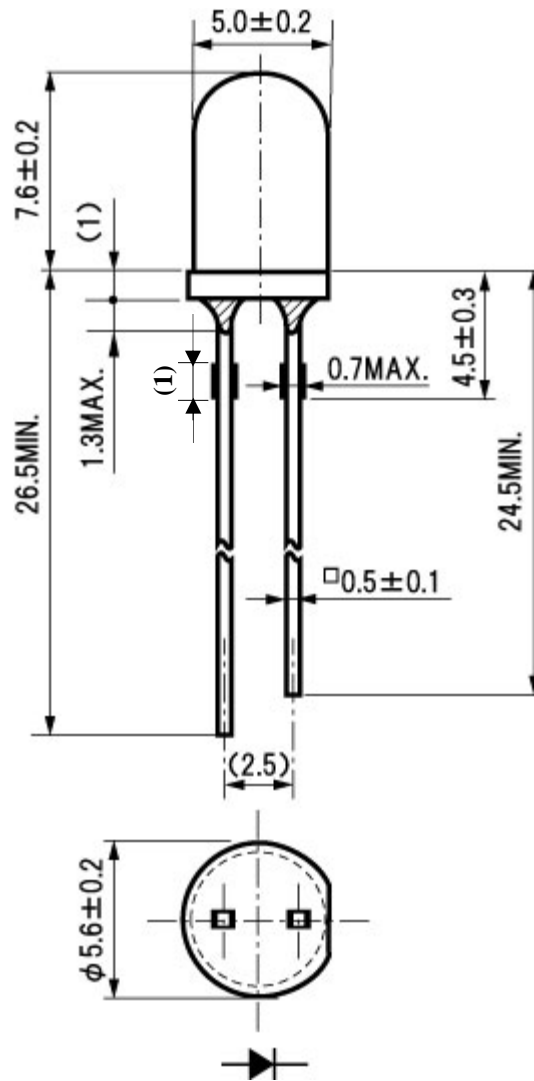



## TTW (Through The Wave) soldering Conditions

---

Pre-heating	100 °C	(MAX.) Resin surface temperature
Solder Bath Temp.	265 °C	(MAX.)
Dipping Time	5 s	(MAX.)
Position	At least 3.0 mm away from the root of lead	

- 1) The dip soldering process shall be twice maximum.
- 2) The product shall be cooled to normal temperature before the second dipping process.
  - ※The detail is described to LED and Photodetector handling precautions of home page:  
"Mounting through-hole Type Devices" and "Soldering", and use it after the confirmation, please.

## Manual Soldering Conditions

---

Iron tip temp.	400 °C	(MAX.) (30 W Max.)
Soldering time and frequency	3 s	(MAX.)
	1 time	(MAX.)
Position	At least 3.0 mm away from the root of lead	

- ※The detail is described to LED and Photodetector handling precautions of home page:  
"Mounting through-hole Type Devices" and "Soldering", and use it after the confirmation, please.

## Reliability Testing Result

Reliability Testing Result	Applicable Standard	Testing Conditions	Duration	Failure
Room Temp. Operating Life	EIAJ ED-4701/100(101)	Ta = 25°C, IF= Maximum Rated Current	1,000 h	0/25
Resistance to Soldering Heat	EIAJ ED-4701/300(302)	265±5°C, 3mm from package base	10s	0/25
Temperature Cycling	EIAJ ED-4701/100(105)	Minimum Rated Storage Temperature(30min) ~ Normal Temperature(15min) ~ Maximum Rated Storage Temperature(30min) ~ Normal Temperature(15min)	5 cycles	0/25
Wet High Temp. Storage Life	EIAJ ED-4701/100(103)	Ta = 60±2°C, RH = 90±5%	1,000 h	0/25
High Temp. Storage Life	EIAJ ED-4701/200(201)	Ta = Maximum Rated Storage Temperature	1,000 h	0/25
Low Temp. Storage Life	EIAJ ED-4701/200(202)	Ta = Minimum Rated Storage Temperature	1,000 h	0/25
Lead Tension	EIAJ ED-4701/400(401)	10N, 1time (□0.4 and Flat Package : 5N)	10s	0/10
Vibration, Variable Frequency	EIAJ ED-4701/400(403)	98.1m/s <sup>2</sup> (10G), 100 ~ 2KHz sweep for 20min., XYZ each direction	2 h	0/10

## Failure Criteria

Items	Symbols	Conditions	Failure criteria
Luminous Intensity	Iv	IF Value of each product Luminous Intensity	Testing Min. Value < Spec. Min. Value x 0.5
Forward Voltage	VF	IF Value of each product Forward Voltage	Testing Max. Value ≥ Spec. Max. Value x 1.2
Reverse Current	IR	VR = Maximum Rated Reverse Voltage V	Testing Max. Value ≥ Spec. Max. Value x 2.5

## Special Notice to Customers Using the Products and Technical Information Shown in This Data Sheet

- 1) The technical information shown in the data sheets are limited to the typical characteristics and circuit examples of the referenced products. It does not constitute the warranting of industrial property nor the granting of any license.
- 2) For the purpose of product improvement, the specifications, characteristics and technical data described in the data sheets are subject to change without prior notice. Therefore it is recommended that the most updated specifications be used in your design.
- 3) When using the products described in the data sheets, please adhere to the maximum ratings for operating voltage, heat dissipation characteristics, and other precautions for use. We are not responsible for any damage which may occur if these specifications are exceeded.
- 4) The products that have been described to this catalog are manufactured so that they will be used for the electrical instrument of the benchmark (OA equipment, telecommunications equipment, AV machine, home appliance and measuring instrument).  
The application of aircrafts, space borne application, transportation equipment, medical equipment and nuclear power control equipment, etc. needs a high reliability and safety, and the breakdown and the wrong operation might influence the life or the human body. Please consult us beforehand if you plan to use our product for the usages of aircrafts, space borne application, transportation equipment, medical equipment and nuclear power control equipment, etc. except OA equipment, telecommunications equipment, AV machine, home appliance and measuring instrument.
- 5) In order to export the products or technologies described in this data sheet which are under the “Foreign Exchange and Foreign Trade Control Law,” it is necessary to first obtain an export permit from the Japanese government.
- 6) No part of this data sheet may be reprinted or reproduced without prior written permission from Stanley Electric Co., Ltd.
- 7) The most updated edition of this data sheet can be obtained from the address below:  
<http://www.stanley-components.com/en/>