

DETAIL A
SCALE 20:1

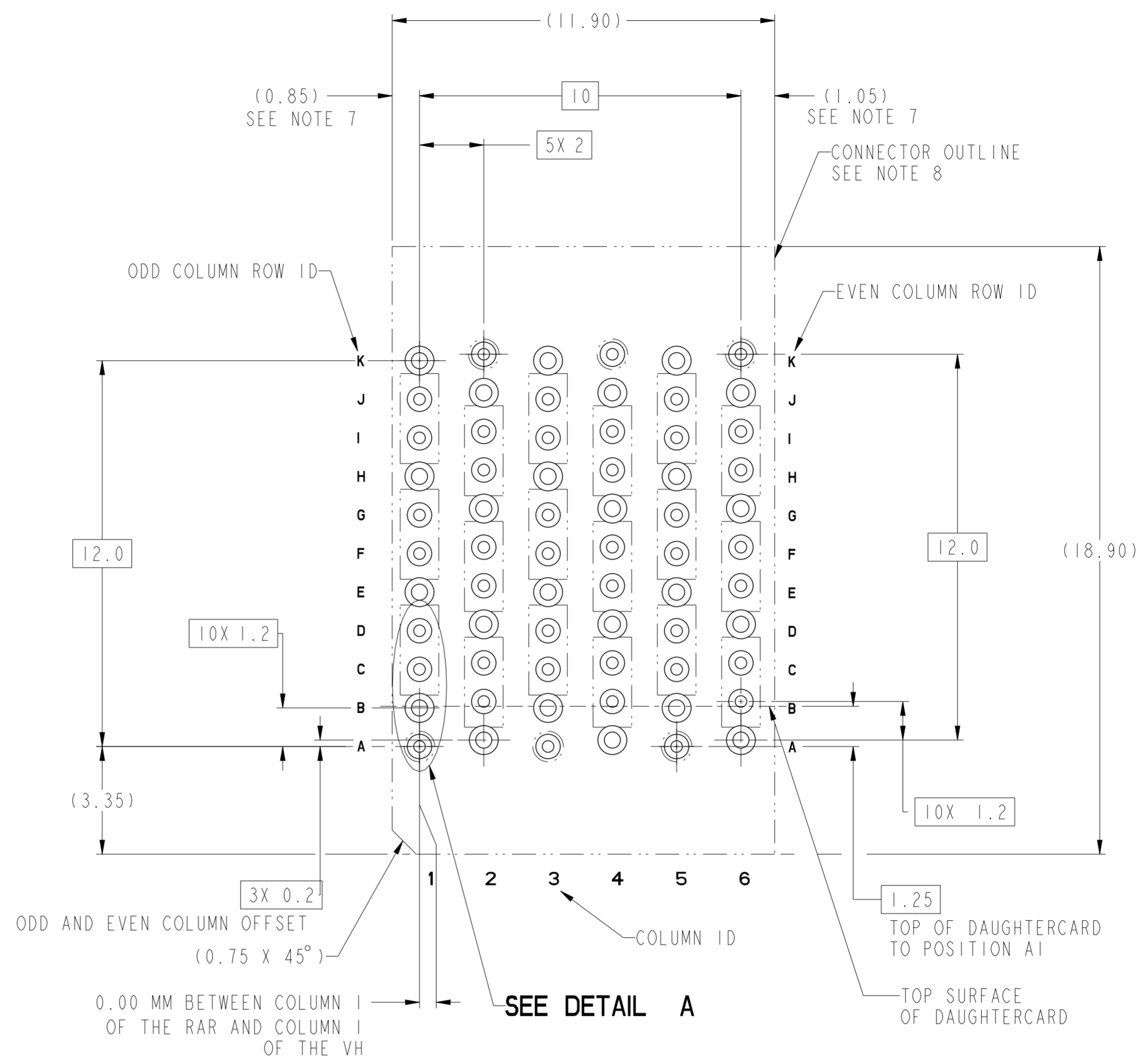

**RECOMMENDED PCB LAYOUT FOR
10128349-Y01LF COMPONENT SIDE
SEE NOTES 7, 8, 9 & 11
SCALE 8:1**

spec ref	SEE NOTES	dr	Daniel Xiao	2014/02/20	projection	MM	size	A2	scale	5:1
tolerance std	TOLERANCES UNLESS OTHERWISE SPECIFIED	eng	Peng-Bing Fu	2017/11/08			ecn no	ELX-DG-28406-1	rel level	Released
ASME Y14.5M		chr	Justin Chen	2017/11/29						
		appr	Heaven Cen	2017/11/30						
surface	linear	0.X	±.3	Amphenol FCI	product family ExaMAX	title ExaMAX VERTICAL HEADER ASS'Y, 3 PAIR, 66 POS, 6 IMLA	dwg no 10128349	rev B	cat. no. Product - Customer Drw	sheet 2 of 11
		0.XX	±.10							
		0.XXX	±.050							
	angular	0°	±2°							

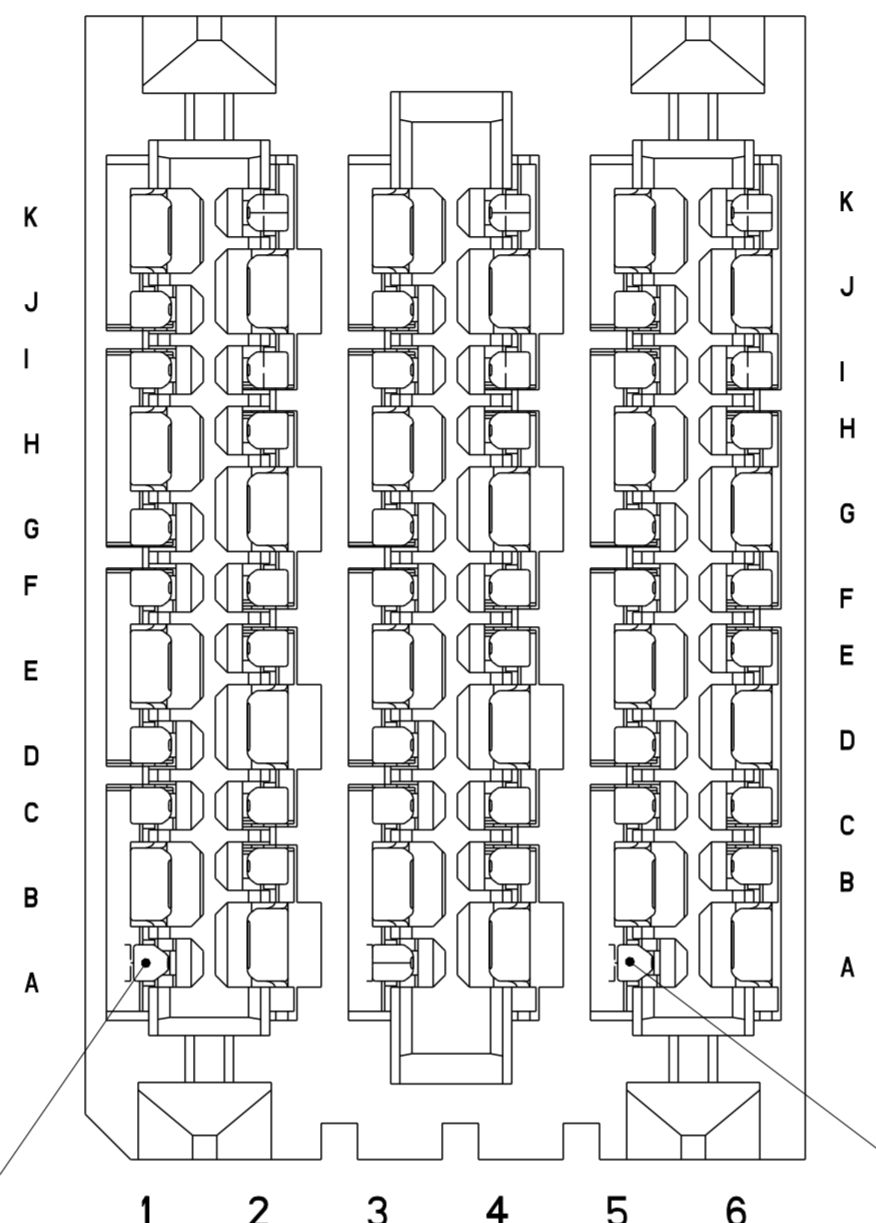

ADVANCED MATE POSITION A1
SEE NOTE 13

ADVANCED MATE POSITION A5
SEE NOTE 13

10128349-201LF
ADVANCED MATE CONNECTOR
 ADVANCED MATE POSITIONS ARE POSITIONS A1 AND A5 ONLY
 FOR ALL DIMENSIONS SEE SHEET 1
 SCALE 8:1

Amphenol
FCi

© 2016 AFci

spec ref	SEE NOTES	dr	Daniel Xiao	2014/02/20	projection	MM	size	A2	scale	5:1
tolerance std	ASME Y14.5M	eng	Peng-Bing Fu	2017/11/08			ecn no	ELX-DG-28406-1		
TOLERANCES UNLESS OTHERWISE SPECIFIED		chr	Justin Chen	2017/11/29			rel level	Released		
surface	-	appr	Heaven Cen	2017/11/30	product family	ExaMAX		rel level	Released	
linear angular	0.X	±.3		title ExaMAX VERTICAL HEADER ASS'Y, 3 PAIR, 66 POS, 6 IMLA	cat. no.	Product - Customer Drw	dwg no 10128349	rev B	sheet 3 of 11	
	0.XX	±.10								
	0.XXX	±.050								
	0°	±2°								

1 2 3 4 5 6 7 8

A

B

C

D

E

F

A

B

C

D

E

F

SHORT DETECT
POSITION K2
SEE NOTE 14

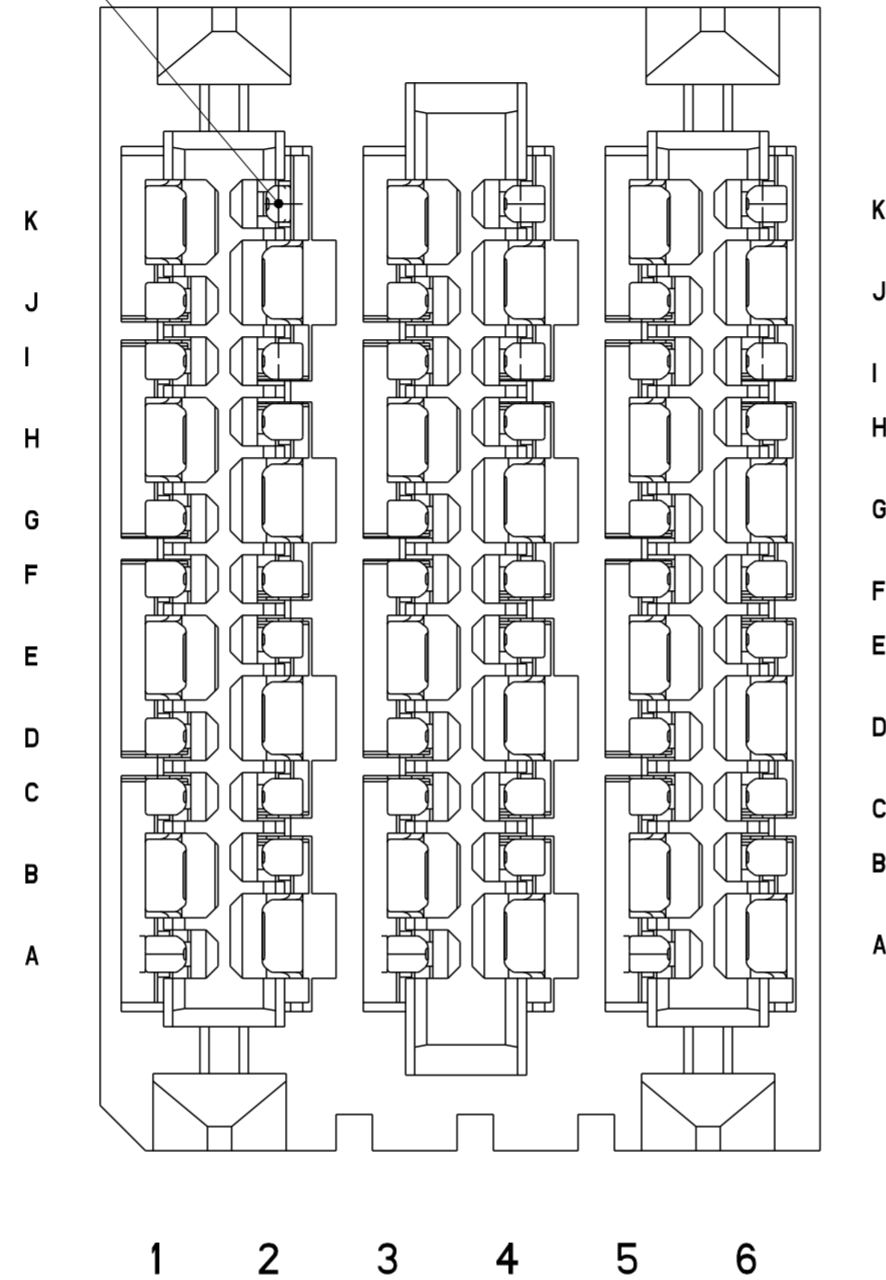

10128349-301LF
SHORT DETECT CONNECTOR
SHORT DETECT POSITIONS IS K2 ONLY
FOR ALL DIMENSIONS SEE SHEET 1
SCALE 8:1

Amphenol
FCi

© 2016 AFCi

spec ref	SEE NOTES	dr	Daniel Xiao	2014/02/20	projection	MM	size	A2	scale	5:1							
tolerance std	TOLERANCES UNLESS OTHERWISE SPECIFIED	eng	Peng-Bing Fu	2017/11/08			ecn no	ELX-DG-28406-1	rel level	Released							
ASME Y14.5M		chr	Justin Chen	2017/11/29													
		appr	Heaven Cen	2017/11/30													
surface	<table border="1"> <tr> <td rowspan="3">-</td> <td rowspan="3">linear</td> <td>0.X</td> <td>±.3</td> </tr> <tr> <td>0.XX</td> <td>±.10</td> </tr> <tr> <td>0.XXX</td> <td>±.050</td> </tr> <tr> <td></td> <td>angular</td> <td>0°</td> <td>±2°</td> </tr> </table>	-	linear	0.X	±.3	0.XX	±.10	0.XXX	±.050		angular	0°	±2°		title ExaMAX VERTICAL HEADER ASS'Y, 3 PAIR, 66 POS, 6 IMLA	dwg no 10128349	rev B
-	linear			0.X	±.3												
				0.XX	±.10												
		0.XXX	±.050														
	angular	0°	±2°														
		cat. no.	Product - Customer Drw			sheet 4 of 11											

SHORT DETECT
POSITION K2
SEE NOTE 15

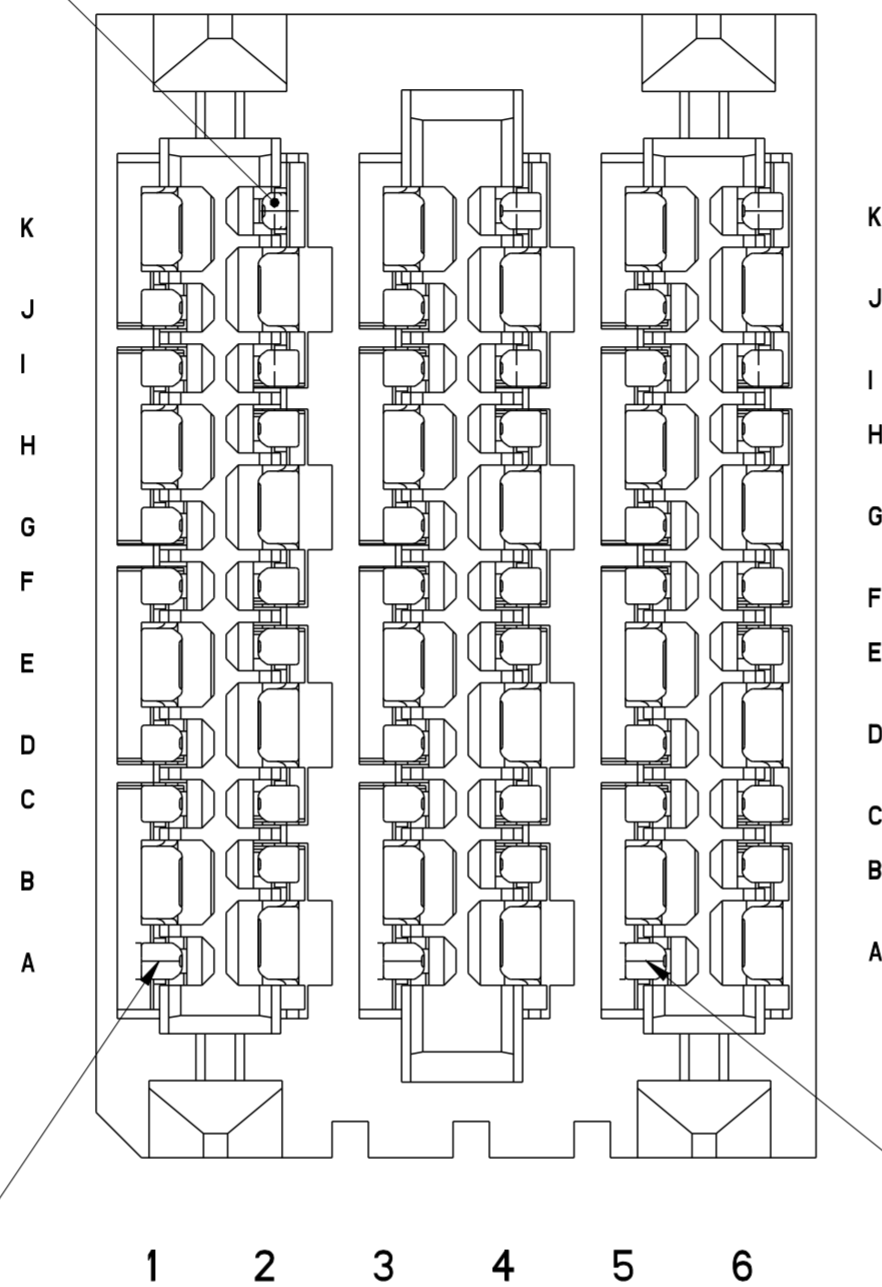

ADVANCED MATE
POSITION A1
SEE NOTE 15

ADVANCED MATE
POSITION A5
SEE NOTE 15

10128349-401LF
ADVANCED MATE/SHORT DETECT CONNECTOR
ADVANCED MATE POSITIONS ARE POSITIONS A1 AND A5 ONLY
SHORT DETECT POSITIONS IS K2 ONLY
FOR ALL DIMENSIONS SEE SHEET 1
SCALE 8:1

Amphenol
FCi

© 2016 AFCI

spec ref	SEE NOTES	dr	Daniel Xiao	2014/02/20	projection	MM	size	A2	scale	3:1											
tolerance std	TOLERANCES UNLESS OTHERWISE SPECIFIED	eng	Peng-Bing Fu	2017/11/08			ecn no	ELX-DG-28406-1													
ASME Y14.5M		chr	Justin Chen	2017/11/29			rel level	Released													
		appr	Heaven Cen	2017/11/30			product family	ExaMAX													
surface	<table border="1"> <tr> <td>linear</td> <td>0.X</td> <td>±.3</td> </tr> <tr> <td></td> <td>0.XX</td> <td>±.10</td> </tr> <tr> <td></td> <td>0.XXX</td> <td>±.050</td> </tr> <tr> <td>angular</td> <td>0°</td> <td>±2°</td> </tr> </table>	linear	0.X	±.3		0.XX	±.10		0.XXX	±.050	angular	0°	±2°	Amphenol FCi	title ExaMAX VERTICAL HEADER ASS'Y, 3 PAIR, 66 POS, 6 IMLA			dwg no	10128349		
linear	0.X	±.3																			
	0.XX	±.10																			
	0.XXX	±.050																			
angular	0°	±2°																			
			cat. no.	Product - Customer Drw			rev	B													

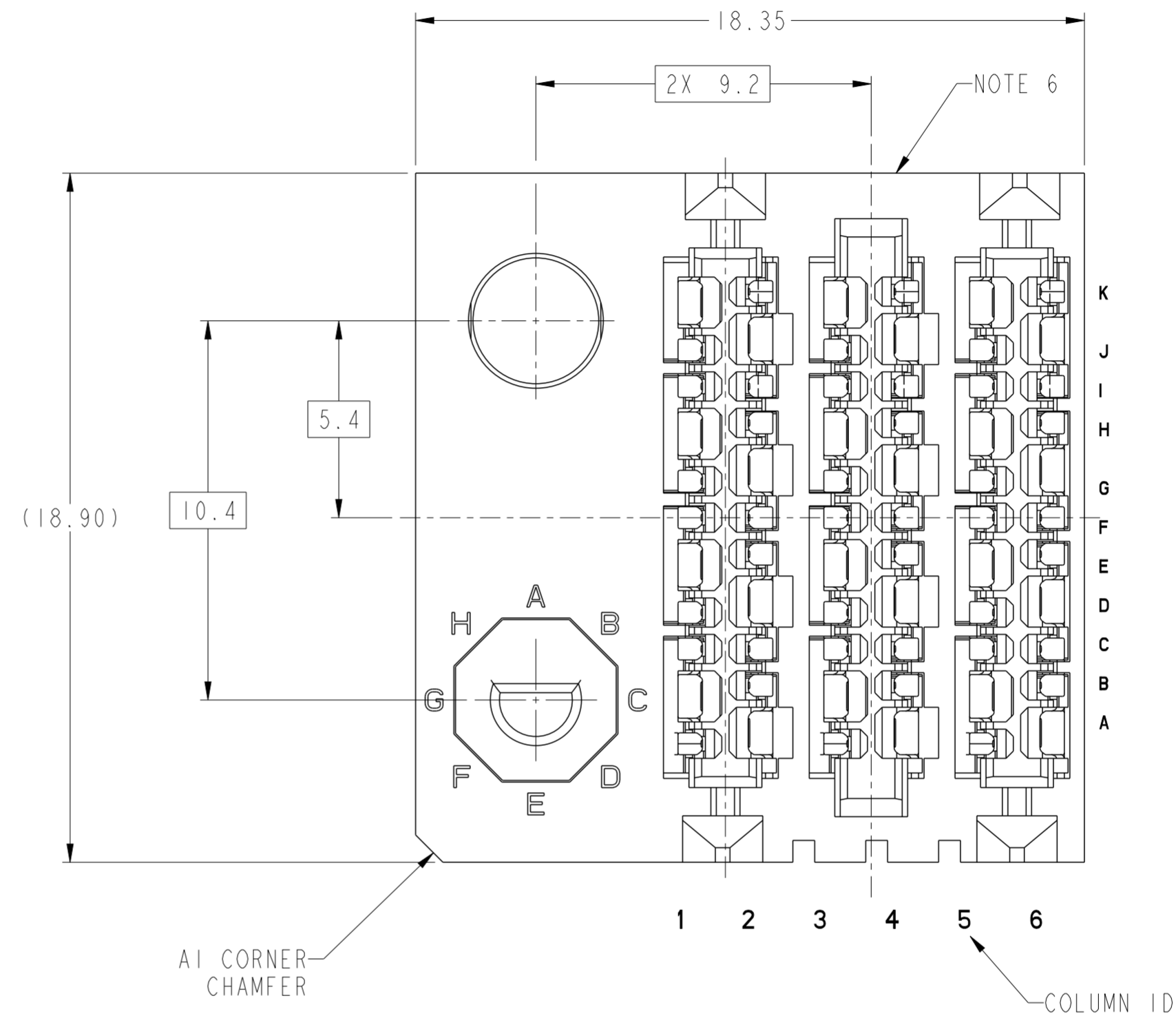
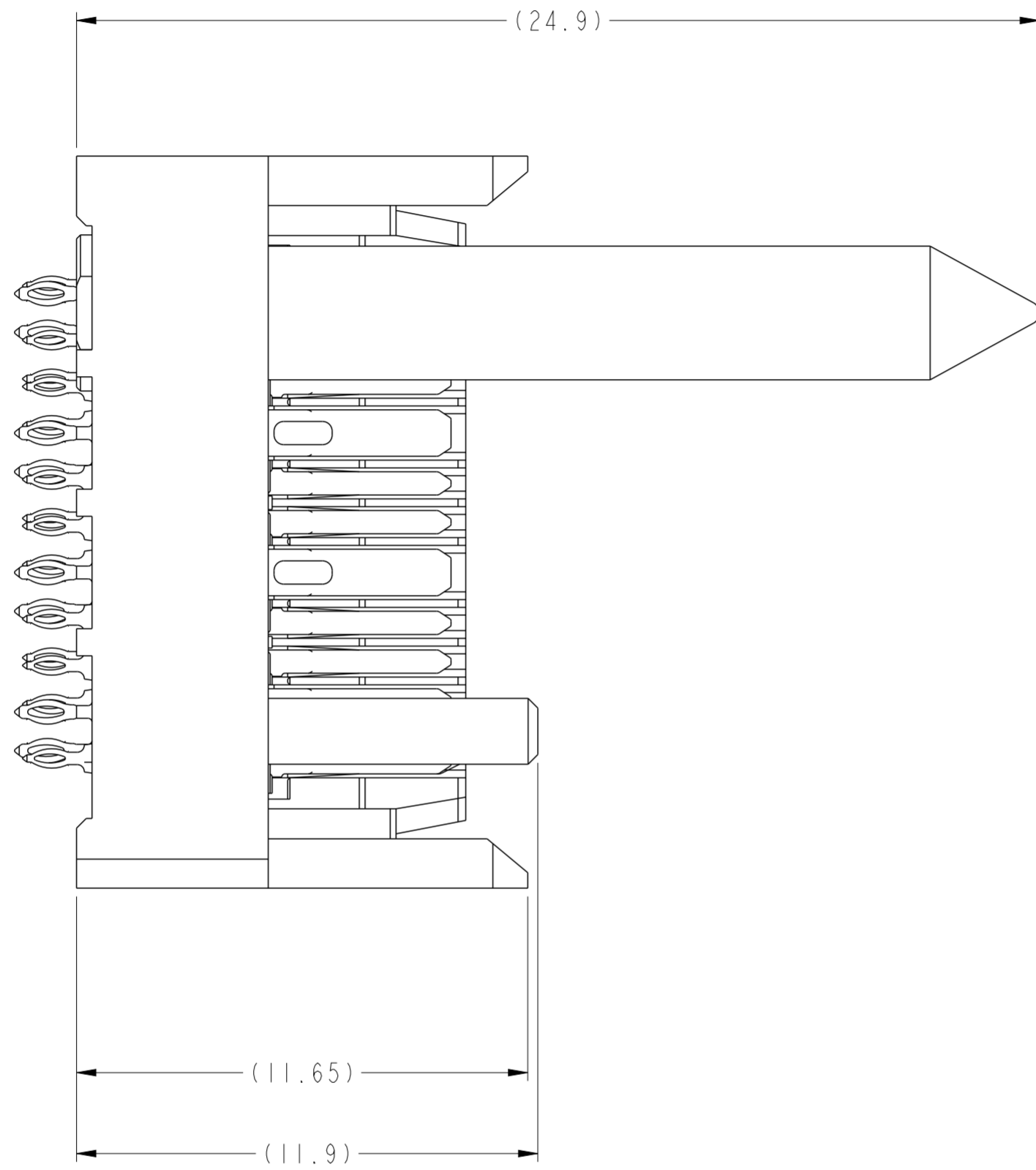

10128349-Y1ALF THRU -Y1JLF
 RIGHT GUIDANCE CONNECTOR (SEE NOTE 17)
 FOR ALL OTHER DIMENSIONS SEE SHEET 1
 SCALE 7:1

spec ref	SEE NOTES	dr	Daniel Xiao	2014/02/20	projection	MM	size	A2	scale	5:1								
tolerance std	TOLERANCES UNLESS OTHERWISE SPECIFIED	eng	Peng-Bing Fu	2017/11/08			ecn no	ELX-DG-28406-1										
ASME Y14.5M		chr	Justin Chen	2017/11/29			rel level	Released										
		appr	Heaven Cen	2017/11/30			product family	ExaMAX										
surface	<table border="1"> <tr> <td>linear</td> <td>0.X</td> <td>±.3</td> </tr> <tr> <td></td> <td>0.XX</td> <td>±.10</td> </tr> <tr> <td></td> <td>0.XXX</td> <td>±.050</td> </tr> <tr> <td>angular</td> <td>0°</td> <td>±2°</td> </tr> </table>	linear	0.X	±.3		0.XX	±.10		0.XXX	±.050	angular	0°	±2°		title ExaMAX VERTICAL HEADER ASS'Y, 3 PAIR, 66 POS, 6 IMLA		dwg no 10128349	rev B
linear	0.X	±.3																
	0.XX	±.10																
	0.XXX	±.050																
angular	0°	±2°																
		cat. no.	Product - Customer Drw			sheet 6 of 11												

PDS: Rev :B

STATUS:Released

Printed: Dec 01, 2017

Amphenol
FCI

© 2016 APCI

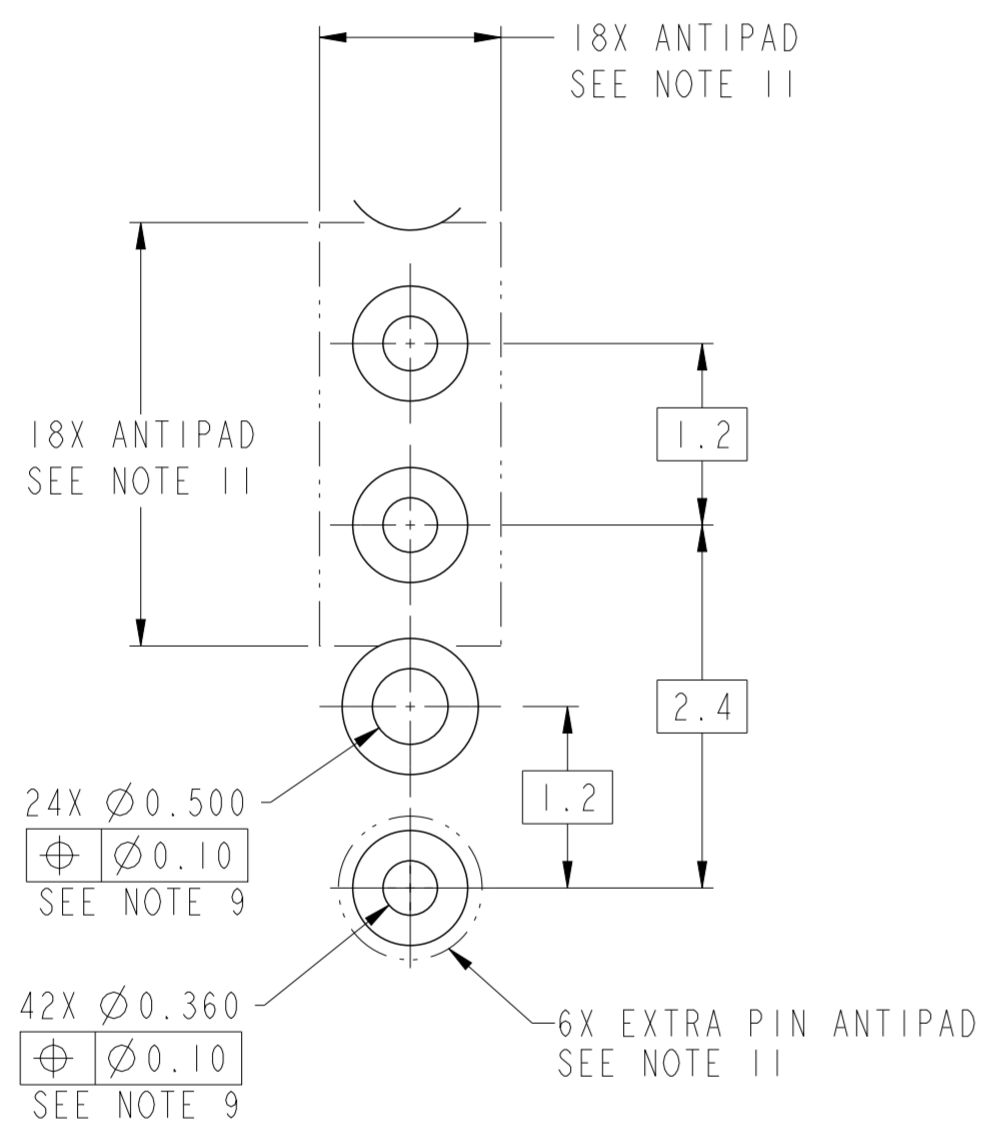

DETAIL C
SCALE 20:1

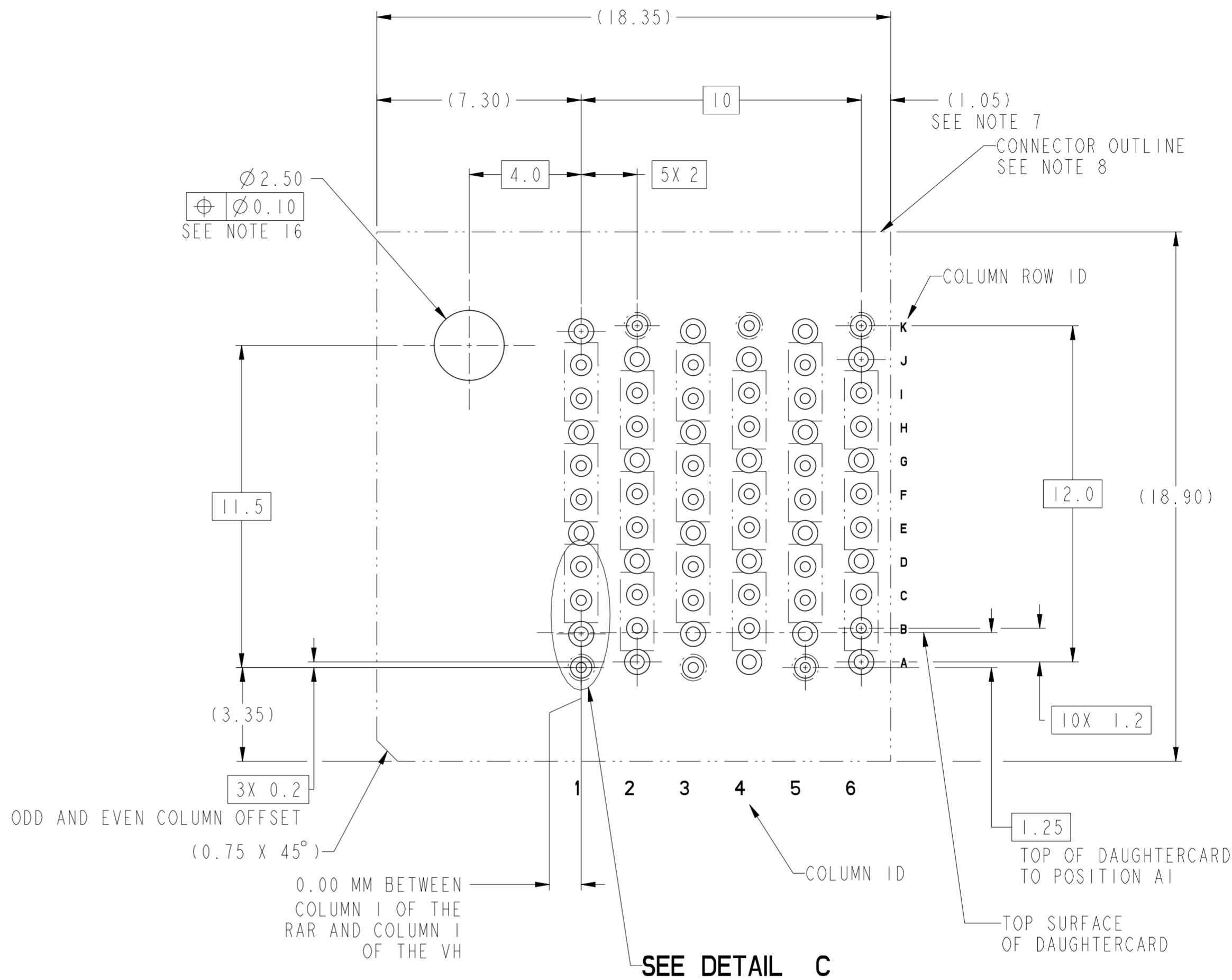

**RECOMMENDED PCB LAYOUT FOR
10128349-Y1YLF COMPONENT SIDE
SEE NOTES 7, 8, 9, 11 & 16
SCALE 7:1**

spec ref	SEE NOTES	dr	Daniel Xiao	2014/02/20	projection	MM	size	A2	scale	2:1	
tolerance std	ASME Y14.5M	eng	Peng-Bing Fu	2017/11/08			ecn no	ELX-DG-28406-1	rel level	Released	
TOLERANCES UNLESS OTHERWISE SPECIFIED		chr	Justin Chen	2017/11/29			product family	ExaMAX		rel level	Released
surface	-	appr	Heaven Cen	2017/11/30			title	ExaMAX VERTICAL HEADER ASS'Y, 3 PAIR, 66 POS, 6 IMLA		dwg no	10128349
	linear	0.X	±.3		cat. no.	Product - Customer Drw	sheet 7 of 11				
		0.XX	±.10								
		0.XXX	±.050								
	angular	0°	±2°								

A

B

C

D

E

F

A

B

C

D

E

F

Amphenol
FCi

© 2016 AFci

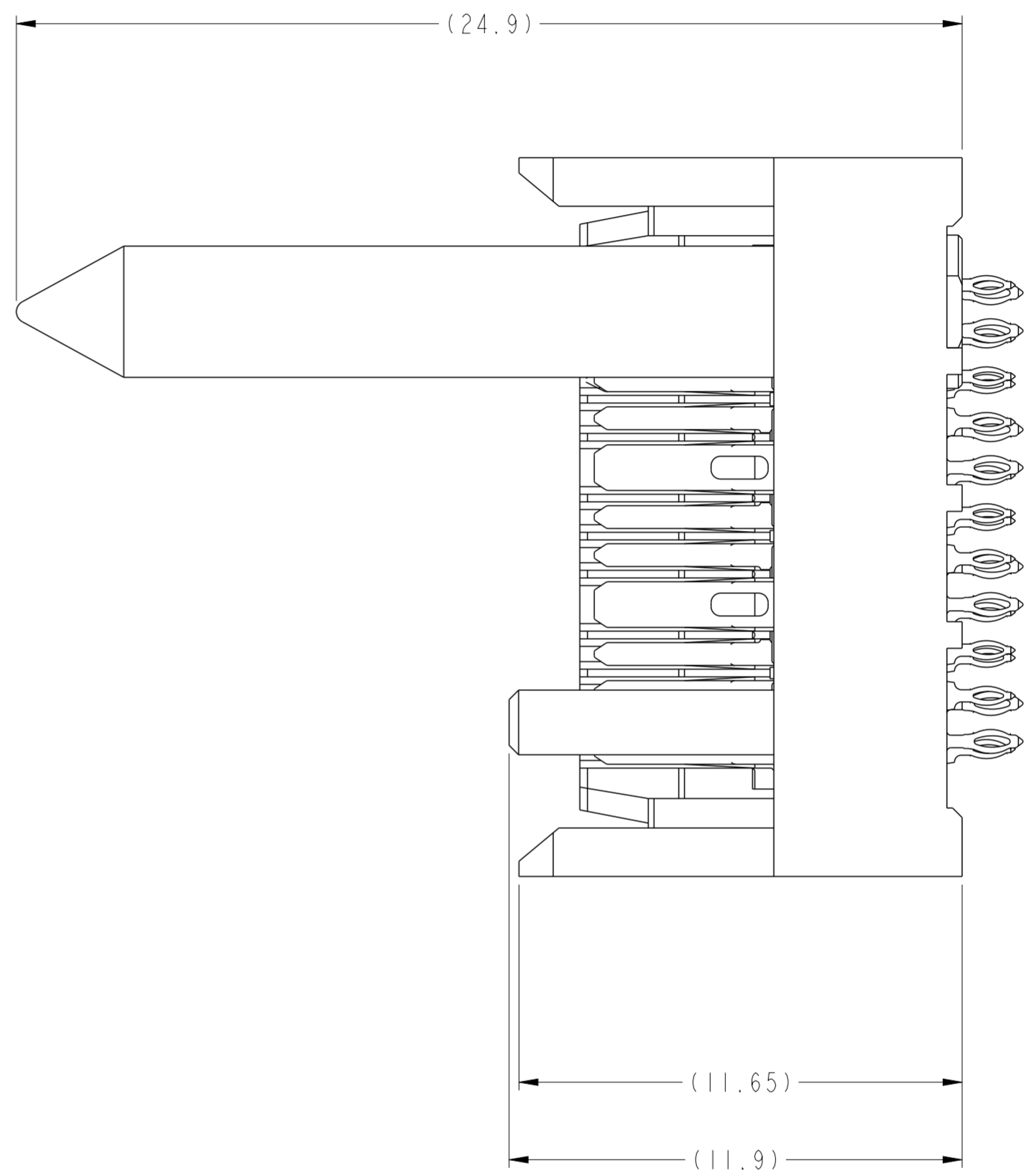
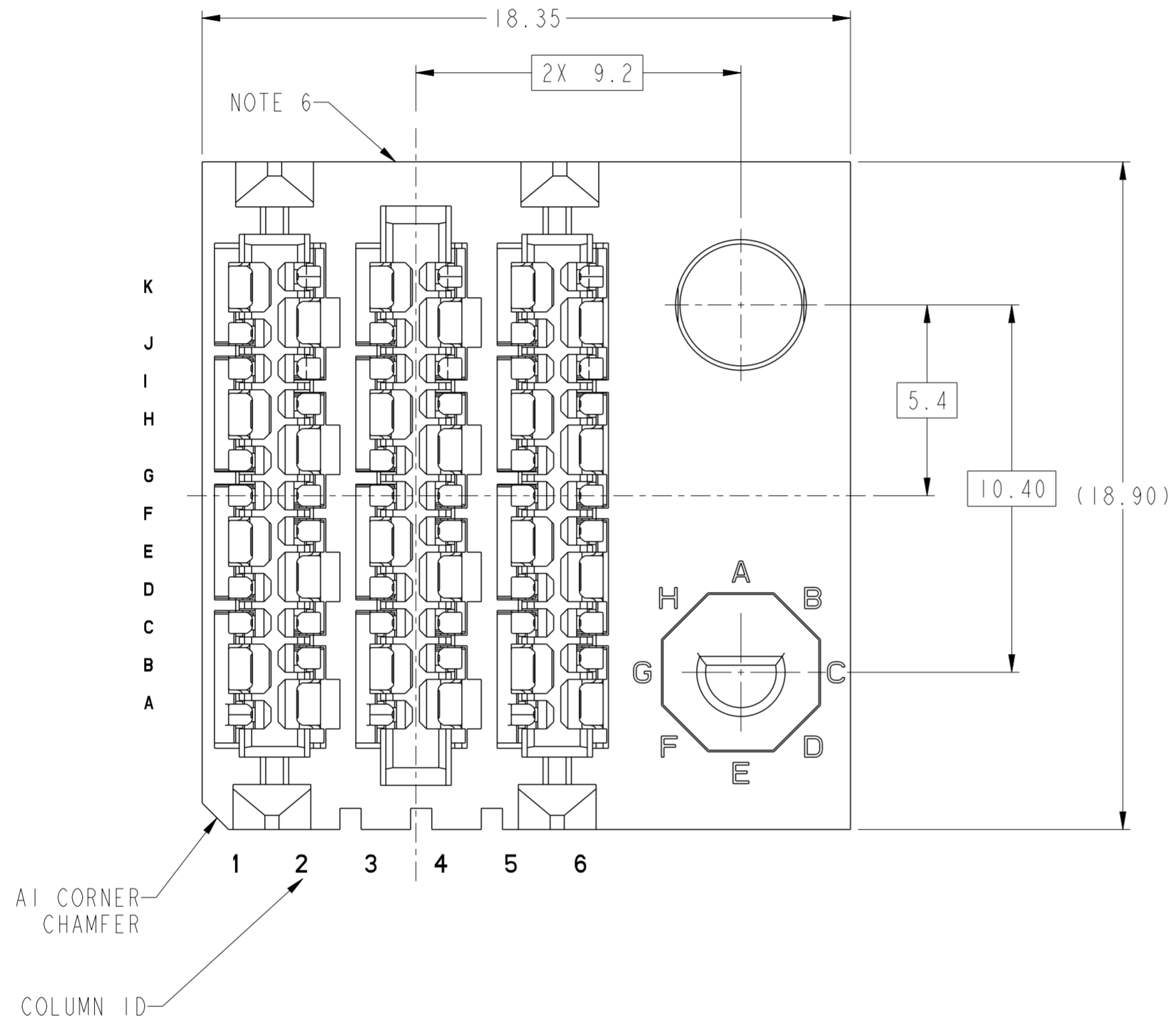

10128349-Y2ALF THRU -Y2JLF
LEFT GUIDANCE CONNECTOR (SEE NOTE 17)
FOR ALL OTHER DIMENSIONS SEE SHEET 1
SCALE 7:1

spec ref	SEE NOTES	dr	Daniel Xiao	2014/02/20	projection	MM	size	A2	scale	3:1											
tolerance std	TOLERANCES UNLESS OTHERWISE SPECIFIED	eng	Peng-Bing Fu	2017/11/08			ecn no	ELX-DG-28406-1	rel level	Released											
ASME Y14.5M		chr	Justin Chen	2017/11/29																	
		appr	Heaven Cen	2017/11/30																	
surface	<table border="1"> <tr> <td>linear</td> <td>0.X</td> <td>±.3</td> </tr> <tr> <td></td> <td>0.XX</td> <td>±.10</td> </tr> <tr> <td></td> <td>0.XXX</td> <td>±.050</td> </tr> <tr> <td>angular</td> <td>0°</td> <td>±2°</td> </tr> </table>	linear	0.X	±.3		0.XX	±.10		0.XXX	±.050	angular	0°	±2°			title ExaMAX VERTICAL HEADER ASS'Y, 3 PAIR, 66 POS, 6 IMLA		product family ExaMAX	rel level Released	dwg no 10128349	rev B
linear	0.X	±.3																			
	0.XX	±.10																			
	0.XXX	±.050																			
angular	0°	±2°																			
		cat. no.	Product - Customer Drw		sheet 8 of 11																

PDS: Rev :B

STATUS:Released

Printed: Dec 01, 2017

10128349 - Y Y Y L F

ASSEMBLY PART NUMBER	DESCRIPTION
10128349-1YYLF	STANDARD MATE
10128349-2YYLF	ADVANCED MATE
10128349-3YYLF	SHORT DETECT
10128349-4YYLF	ADVANCED MATE & SHORT DETECT

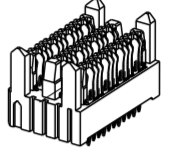
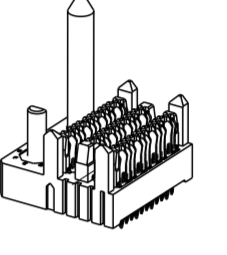
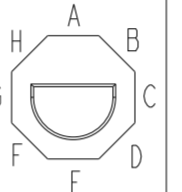
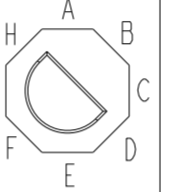
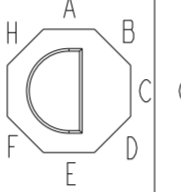
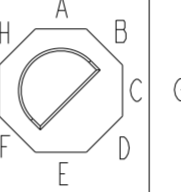
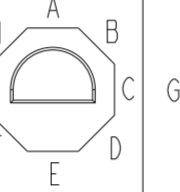
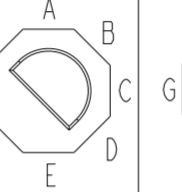
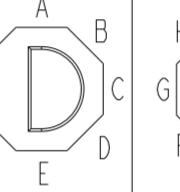
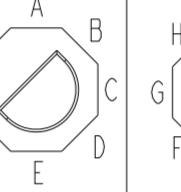
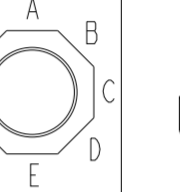
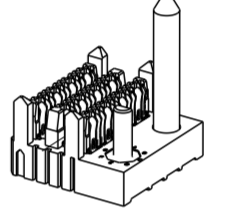
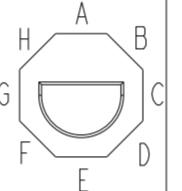
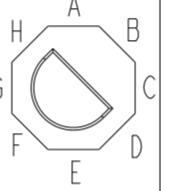
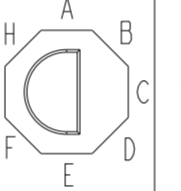
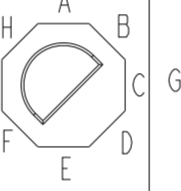
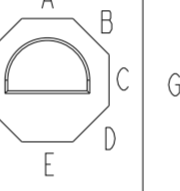
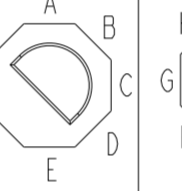
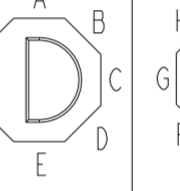
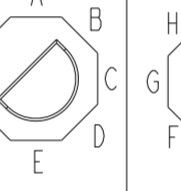
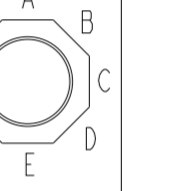
MODULE DESCRIPTION	DESIGNATION REPRESENTED IN DASH NUMBER									BASE MODULE
STANDARD NO GUIDANCE (SEE SHEET 1)	01									
RIGHT GUIDANCE MODULE (SEE SHEET 6)	1A	1B	1C	1D	1E	1F	1G	1H	1J (NO KEY)	
										
LEFT GUIDANCE MODULE (SEE SHEET 8)	2A	2B	2C	2D	2E	2F	2G	2H	2J (NO KEY)	
										

Amphenol
FCi

© 2016 AFCi

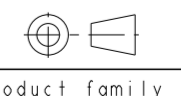
spec ref	SEE NOTES	dr	Daniel Xiao	2014/02/20	projection	MM	size	A2	scale	5:1
tolerance std	TOLERANCES UNLESS OTHERWISE SPECIFIED	eng	Peng-Bing Fu	2017/11/08		← →	ecn no	ELX-DG-28406-1	rel level	Released
ASME Y14.5M		chr	Justin Chen	2017/11/29						
		appr	Heaven Cen	2017/11/30						
surface	linear	0.X	±.3	Amphenol FCi	title	ExaMAX VERTICAL HEADER	cat. no.	Product - Customer Drw	sheet 10 of 11	
✓		0.XX	±.10							
		0.XXX	±.050							
	angular	0°	±2°							
		PDS: Rev :B		STATUS:Released		Printed: Dec 01, 2017				

NOTES:

- ① - CONNECTOR MATERIALS:
HOUSING: HIGH TEMP THERMOPLASTIC, BLACK, UL94-V0
IMLA PLASTIC: HIGH TEMP THERMOPLASTIC, BLACK, UL94-V0
CONTACT: COPPER ALLOY
GUIDE PIN: ZINC ALLOY
KEY PIN: ZINC ALLOY
- 2 - CONTACT PLATING:
SEPARABLE INTERFACE:
PERFORMANCE-BASED PLATING, QUALIFIED TO MEET THE REQUIREMENTS OF FCI PRODUCT SPECIFICATION GS-12-1096 INCLUDING TELCORDIA GR-1217-CORE (NOVEMBER 1995) CENTRAL OFFICE TEST SEQUENCE

PRESS-FIT TAILS: TIN OVER NICKEL (LEAD FREE)
- 3 - PRODUCT SPECIFICATION: GS-12-1096
- 4.- APPLICATION SPECIFICATION GS-20-0361.
- 5 - PACKAGING MEETS GS-14-920 LEAD FREE LABELING SPECIFICATION.
- ⑥ - PRODUCT MARKING, (PROTOTYPE, PART NUMBER & LOT CODE), ON THIS SURFACE.
- ⑦ - THE MINIMUM VIA SPACING BETWEEN STACKED CONNECTORS WILL BE 2.0 mm OR 3.0 mm AS DEFINED BY NOTE 7 ON THE MATING RECEPTACLE CUSTOMER DRAWING. REFER TO THE APPLICATION SPECIFICATION FOR DETAILS.
- ⑧ - CONNECTOR OUTLINE MAY BE SCREEN PRINTED ONTO CUSTOMER PCB TO BE USED AS A GUIDE FOR MANUAL CONNECTOR PLACEMENT.
- ⑨ - REFER TO CUSTOMER DRAWING 10119933 FOR INFORMATION ON PCB HOLE DIAMETERS AND PLATING OPTIONS.
- 10 - THIS PRODUCT MEETS THE EUROPEAN UNION DIRECTIVES & OTHER COUNTRY REGULATIONS AS DESCRIBED IN GS-47-0004.
- ⑪ - REFER TO ROUTING GUIDE GS-20-0511 FOR RECOMMENDATIONS ON OPTIMIZATION OF FOOTPRINT AND TRACE ROUTING LAYOUT.
- 12 - THE HOUSING WILL WITHSTAND EXPOSURE TO 260° C PEAK TEMPERATURE FOR 10-30 SECONDS IN A CONVECTION, INFRA-RED OR VAPOR PHASE REFLOW OVEN.
- ⑬ - THE ADVANCED MATE HEADER, 10128349-2YYLF, WHEN MATED WITH AN ADVANCED MATE RECEPTACLE WILL PROVIDE 2 PAIRS OF MATING CONTACTS THAT MATE 0.75MM BEFORE THE REMAINDER OF THE SIGNAL AND GROUND CONTACTS.
- ⑭ - THE SHORT DETECT HEADER, 10128349-3YYLF, WHEN MATED WITH A STANDARD MATE RECEPTACLE WILL PROVIDE 1 PAIR OF MATING CONTACTS THAT MATE 1.00 MM AFTER THE REMAINDER OF THE SIGNAL AND GROUND CONTACTS.
- ⑮ - THE ADVANCED MATE /SHORT DETECT HEADER, 10128349-4YYLF, WHEN MATED WITH AN ADVANCED MATE RECEPTACLE WILL PROVIDE 2 PAIRS OF MATING CONTACTS THAT MATE 0.75MM BEFORE THE REMAINDER OF THE SIGNAL AND GROUND CONTACTS, AND 1 PAIR OF MATING CONTACTS THAT MATE 1.00 MM AFTER THE REMAINDER OF THE SIGNAL AND GROUND CONTACTS.
- ⑯ - FOR CONNECTOR WITH EITHER A LEFT OR RIGHT GUIDE MODULE, ONE PHILLIPS PAN HEAD M2 HOLD DOWN SCREW MUST BE USED TO SECURE GUIDE PIN/CONNECTOR TO THE PCB. THE SCREW LENGTH SHALL BE 2.0 - 6.0mm PLUS THE THICKNESS OF THE BOARD. SCREW IS NOT PROVIDED WITH CONNECTOR.
- ⑰ - LEFT / RIGHT INTEGRATED GUIDE ORIENTATION IS DETERMINED BY THE LOCATION OF THE GUIDE FEATURES WHEN LOOKING AT THE MATING FACE OF THE RIGHT ANGEL RECEPTACLE. THE LEFT / RIGHT DESIGNATION OF THE MATING HEADER IS DEFINED BY THE RIGHT ANGEL RECEPTACLE THAT IT MATES WITH (i. e. A RIGHT GUIDE VERTICAL HEADER MATES A RIGHT GUIDE RIGHT ANGEL RECEPTACLE.)
- ⑱ - ALL GROUND CONTACTS ARE COMMONED WITHIN A COLUMN.

spec ref	SEE NOTES	dr	Daniel Xiao	2014/02/20	projection	MM	size	A2	scale	2:1
tolerance std	TOLERANCES UNLESS OTHERWISE SPECIFIED	eng	Peng-Bing Fu	2017/11/08		← MM →	ecn no	ELX-DG-28406-1	rel level	Released
ASME Y14.5M		chr	Justin Chen	2017/11/29						
surface	linear	appr	Heaven Cen	2017/11/30	product family	ExaMAX	rel level	Released	title	ExaMAX VERTICAL HEADER
	0.X ±.3								dwg no	10128349
	0.XX ±.10								rev	B
	0.XXX ±.050								cat. no.	Product - Customer Drw
	angular								sheet 11 of 11	
	0° ±2°									