

MATERIALS AND FINISHES

BODY: ZINC
PLATED: NICKEL

CENTER CONTACT: PHOSPOR BRONZE
PLATED: GOLD

OUTER CONTACT: BeCu
PLATED: NICKEL

CRIMP TUBE: BRASS
PLATED: NICKEL

OUTER CASING: NYLON
KEYING: SEE TABLE
COLOR: SEE TABLE

INSULATOR: TEFLON

CABLE: RG174, 188, & 316

RETENTION SPECIFICATION:

THE SHROUD WILL WITHSTAND A
LONGITUDINAL FORCE OF 24.73 POUNDS (110N)

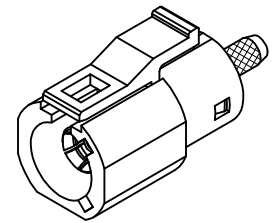
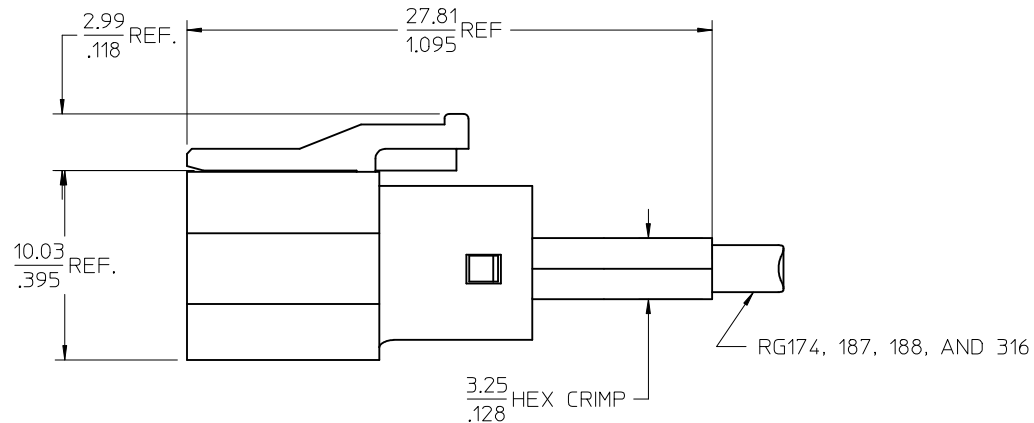
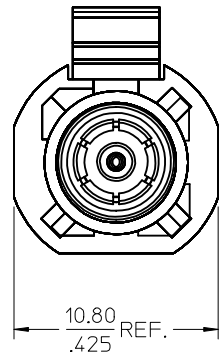

FAKRA
CONNECTOR
KEYING
CODE D SHOWN

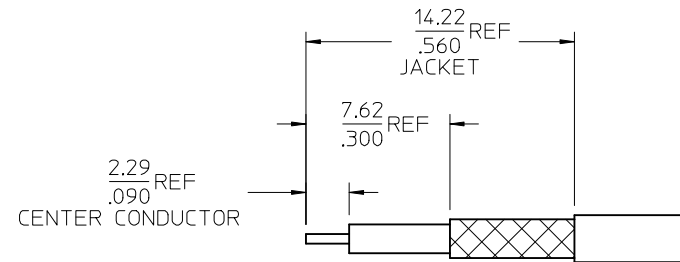
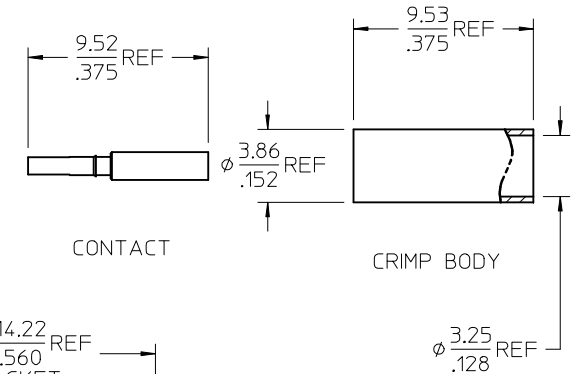
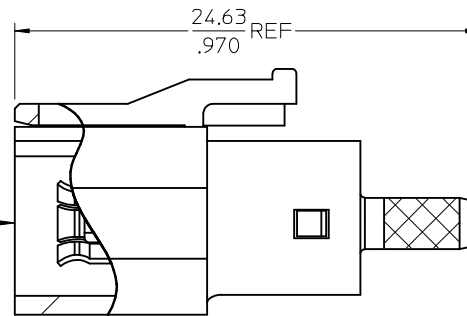

PART # SEE SHEET 2

PS-89675-331	PRODUCT SPECIFICATION
DIN 72594-1	INTERFACE SPECIFICATION
SPECIFICATION	DESCRIPTION

ADDED DIM. PER RF15-E055	EC NO: URF2016-0677	2016/04/08
DRWN: LIN	CHKD:	2016/04/20
APPR: YCHENG	DESCRIPTION	
REV: B4	DESCRIPTION	

QUALITY SYMBOLS	GENERAL TOLERANCES (UNLESS SPECIFIED)
▽=0	mm INCH
▽=0	4 PLACES ± --- ± ---
	3 PLACES ± --- ± ---
	2 PLACES ± --- ± ---
	1 PLACE ± --- ± ---
	ANGULAR ± 2 °
	DRAFT WHERE APPLICABLE MUST REMAIN WITHIN DIMENSIONS

DIMENSION STYLE	SCALE
MM/IN	DESIGN UNITS METRIC
DRAWN BY	DATE
SSS	2001/03/07
CHECKED BY	DATE
TEF	2001/03/07
APPROVED BY	DATE
GMH	2001/03/07
MATERIAL NO.	DOCUMENT NO.
SEE SHT 2	SD-73415-291
SIZE	SHEET NO.
C	1 OF 3

THIRD ANGLE PROJECTION	TITLE
	SMB PLUG, FAKRA RG174,188,316 CABLE SMB-JC
MOLEX	MOLEX INCORPORATED
	THIS DRAWING CONTAINS INFORMATION THAT IS PROPRIETARY TO MOLEX INCORPORATED AND SHOULD NOT BE USED WITHOUT WRITTEN PERMISSION

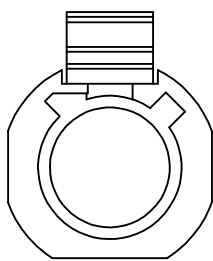

CODE - A

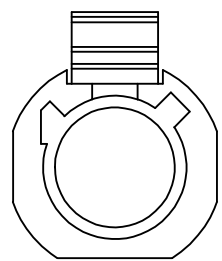

CODE - B

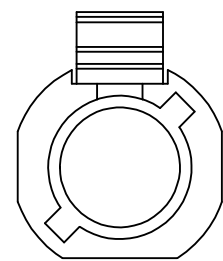

CODE - C

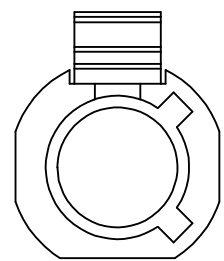

CODE - D

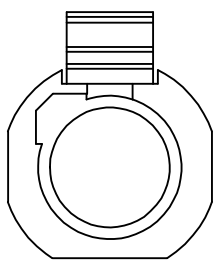

CODE - E

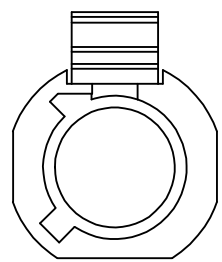

CODE - F

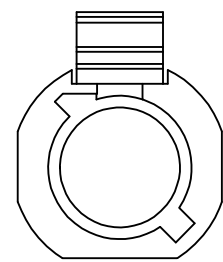

CODE - G

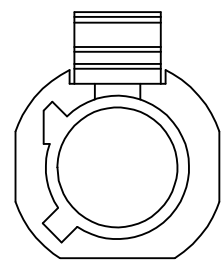

CODE - H

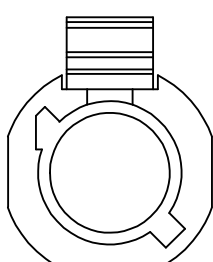

CODE - I

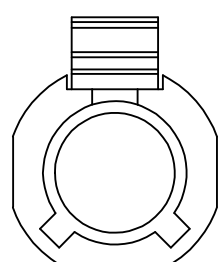

CODE - K

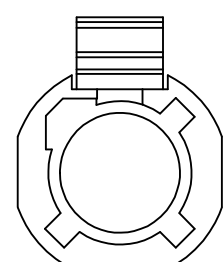

CODE - Z

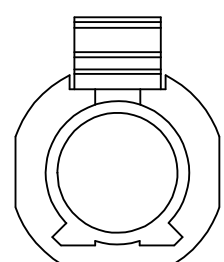

CODE - L

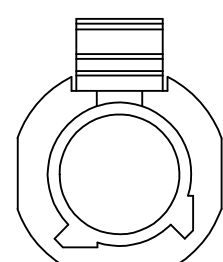

CODE - M

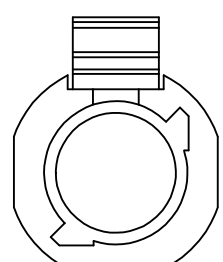

CODE - N

N	PASTEL GREEN	73415-2923
M	PASTEL ORANGE	73415-2922
L	CARMINE RED	73415-2921
Z	WATER BLUE	73415-2920
K	CURRY YELLOW	73415-2919
I	BEIGE	73415-2918
H	VIOLET	73415-2917
G	GRAY	73415-2916
F	BROWN	73415-2915
E	GREEN	73415-2914
D	BORDEAUXVIOLET	73415-2913
C	BLUE	73415-2912
B	CREAM WHITE	73415-2911
A	BLACK	73415-2910
KEYING CODE	COLOR	PART NO.

SEE SHEET 1 EC NO: URF2016-0677 DRWNLIN 2016/04/08 CHKD: APPR: YCHENG 2016/04/20 B4	QUALITY SYMBOLS ▽=0 ▽=0	GENERAL TOLERANCES (UNLESS SPECIFIED) <table border="1"> <tr> <th></th> <th>mm</th> <th>INCH</th> </tr> <tr> <td>4 PLACES</td> <td>± .---</td> <td>± .---</td> </tr> <tr> <td>3 PLACES</td> <td>± .---</td> <td>± .---</td> </tr> <tr> <td>2 PLACES</td> <td>± .---</td> <td>± .---</td> </tr> <tr> <td>1 PLACE</td> <td>± .---</td> <td>± .---</td> </tr> </table> ANGULAR ± 2 °		mm	INCH	4 PLACES	± .---	± .---	3 PLACES	± .---	± .---	2 PLACES	± .---	± .---	1 PLACE	± .---	± .---	DIMENSION STYLE MM/IN DRAWN BY DATE SSS 2001/03/07 CHECKED BY DATE TEF 2001/03/07 APPROVED BY DATE GMH 2001/03/07	SCALE DESIGN UNITS METRIC THIRD ANGLE PROJECTION	TITLE SMB PLUG, FAKRA RG174,188,316 CABLE SMB-JC	MATERIAL NO. SEE TABLE	DOCUMENT NO. SD-73415-291	SHEET NO. 2 OF 3
		mm	INCH																				
	4 PLACES	± .---	± .---																				
	3 PLACES	± .---	± .---																				
2 PLACES	± .---	± .---																					
1 PLACE	± .---	± .---																					
DRAFT WHERE APPLICABLE MUST REMAIN WITHIN DIMENSIONS		THIS DRAWING CONTAINS INFORMATION THAT IS PROPRIETARY TO MOLEX INCORPORATED AND SHOULD NOT BE USED WITHOUT WRITTEN PERMISSION																					

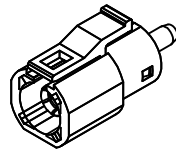

P/N 73415-291*

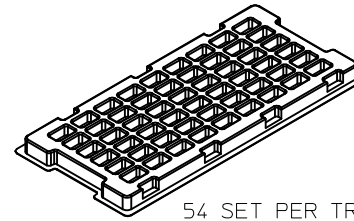

54 SET PER TRAY
TRAY P/N 89707-0220

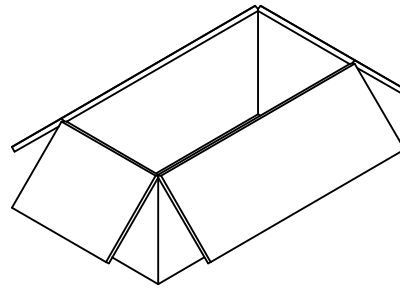

648 SET PER INNER
CARTON BOX
P/N 96707-0001

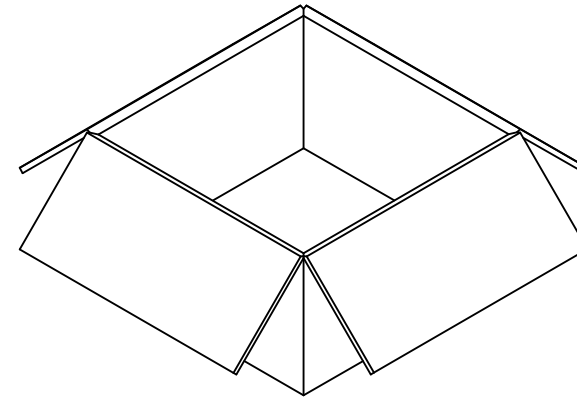

1296 SET PER OUTER
CARTON BOX
P/N 96708-0005

SEE SHEET 1 EC NO: URF2016-0677 DRWNLIN 2016/04/08 CHKD: APPR: YCHENG 2016/04/20	QUALITY SYMBOLS	GENERAL TOLERANCES (UNLESS SPECIFIED)		DIMENSION STYLE MM/IN		SCALE	DESIGN UNITS METRIC	THIRD ANGLE PROJECTION	
	▽=0	mm	INCH	DRAWN BY	DATE	TITLE			
	▽=0	4 PLACES ± --- ± ---	3 PLACES ± --- ± ---	SSS	2001/03/07	SMB PLUG, FAKRA RG174,188,316 CABLE SMB-JC			
		2 PLACES ± --- ± ---	1 PLACE ± --- ± ---	CHECKED BY	DATE	MOLEX INCORPORATED			
	ANGULAR ± 2 °		APPROVED BY		DATE	DOCUMENT NO.		SHEET NO.	
	DRAFT WHERE APPLICABLE MUST REMAIN WITHIN DIMENSIONS		GMH		2001/03/07	SD-73415-291		3 OF 3	
REV	MATERIAL NO.		SIZE		THIS DRAWING CONTAINS INFORMATION THAT IS PROPRIETARY TO MOLEX INCORPORATED AND SHOULD NOT BE USED WITHOUT WRITTEN PERMISSION				
B4	-----		C						