

LAURA-WW-PIN

~65° wide beam optimized for CREE XP-E.
Assembly with white holder, installation tape
and location pins.

TECHNICAL SPECIFICATIONS:

Dimensions	21.6 x 21.6 mm
Height	13.1 mm
Fastening	tape, pin
Colour	white
Box size	
Box weight	7.7 kg
Quantity in Box	1440 pcs
ROHS compliant	yes ⓘ



MATERIAL SPECIFICATIONS:

Component	Type	Material	Colour
LAURA-WW	Lens	PMMA	
LAURA-PIN-XP-HLD-WHT	Holder	PC	white
ROSE-TAPE	Tape	PU tape	black

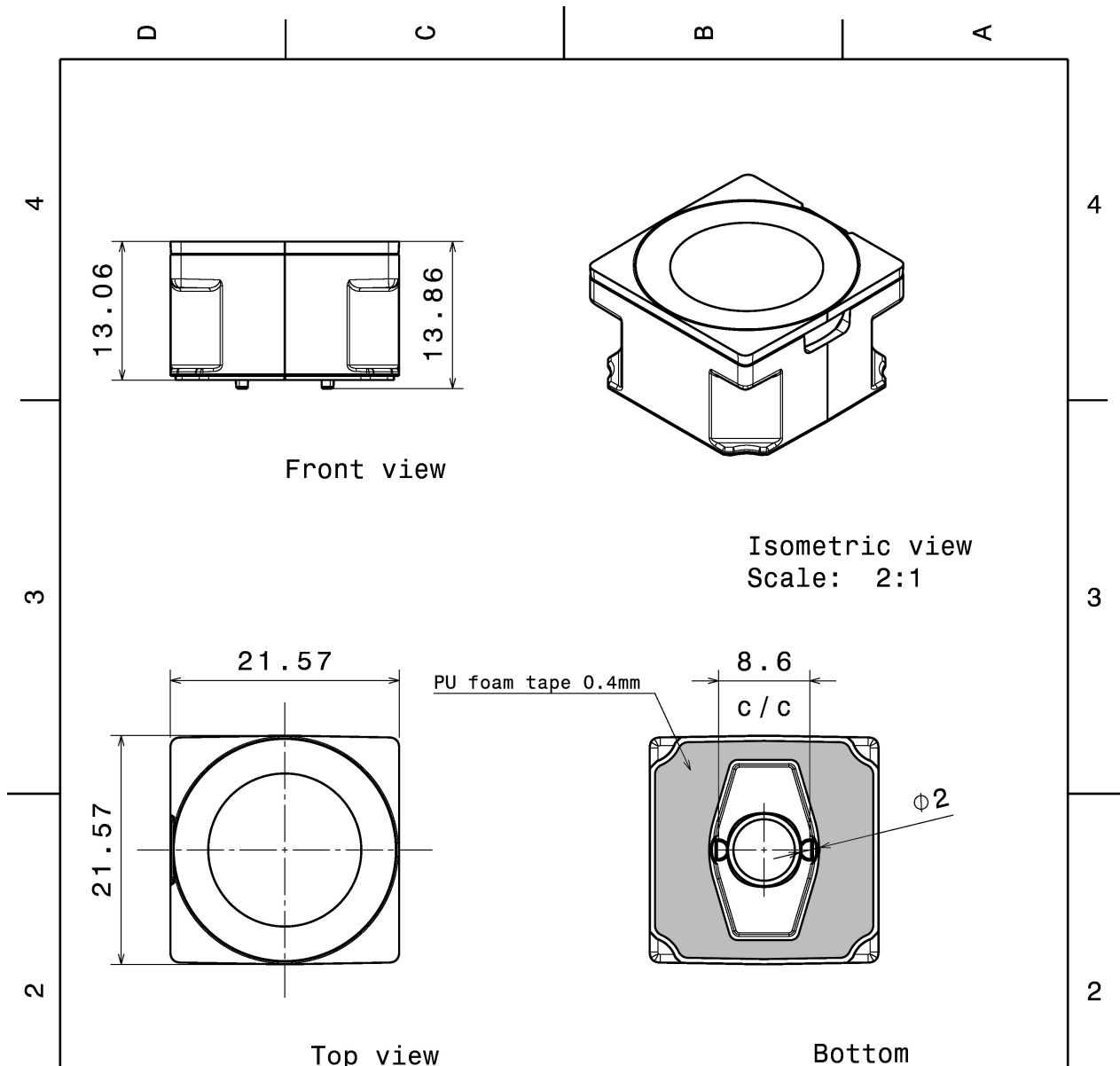

INDEX	PART NO	DESCRIPTION	MATERIAL	COLOUR
1	-	Laura-mech	PMMA	
3	C11835	LAURA-PIN-XP-HLD-WHT	PC	white

Tolerances if not otherwise shown
According to DIN ISO 2768-1
Linear measures:
Up to 30mm class M, otherwise class C.
According to DIN ISO 2768-2
Form and position: class L

LEDiL

Ledil Oy
Salorankatu 10
FIN 24240 SALO
Finland

THIRD ANGLE PROJECTION:

DRAWING TITLE

LAURA-XP-PIN-WHT assembly

This drawing is the property of LEDiL Oy. It may not be reproduced, copied or communicated without a written agreement with LEDiL Oy.

SIZE PART NUMBER

A4

-

SCALE 2:1 WEIGHT 9 g SHEET 1/1

PHOTOMETRIC DATA (MEASURED):

CREE ⇄

LED XB-D
FWHM 48.0°
Efficiency 86 %
Peak intensity 0.900 cd/lm
Required components:

CREE ⇄

LED XP-E
FWHM 66.0°
Efficiency 86 %
Peak intensity 0.700 cd/lm
Required components:

CREE ⇄

LED XP-G
FWHM 68.0°
Efficiency 86 %
Peak intensity 0.640 cd/lm
Required components:

LUMILEDS

LED LUXEON Rebel
FWHM 56.0°
Efficiency %
Peak intensity 1.000 cd/lm
Required components:

PHOTOMETRIC DATA (MEASURED):

LUMILEDS

LED LUXEON T
 FWHM 65.0°
 Efficiency 87 %
 Peak intensity 0.800 cd/lm
 Required components:

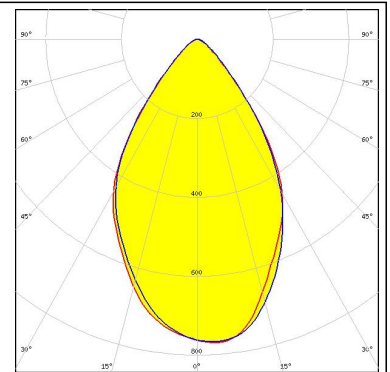
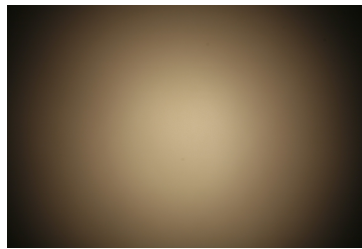

LUMILEDS

LED LUXEON Z ES
 FWHM 44.0°
 Efficiency 91 %
 Peak intensity 1.150 cd/lm
 Required components:

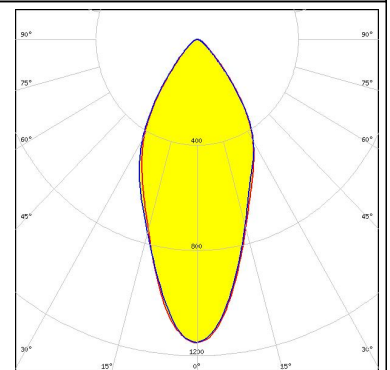
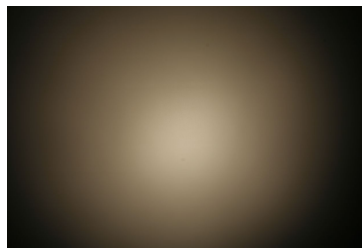

NICHIA

LED NCSxx19B
 FWHM 49.0°
 Efficiency 88 %
 Peak intensity 1.100 cd/lm
 Required components:

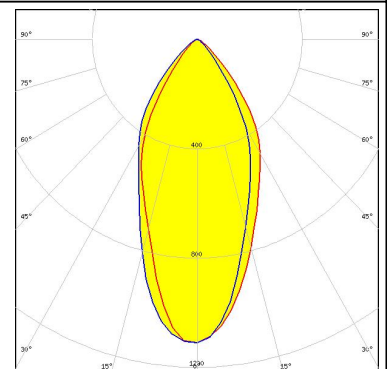
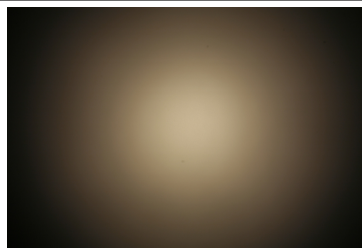

NICHIA

LED NF2x757D
 FWHM 42.0°
 Efficiency 88 %
 Peak intensity 1.300 cd/lm
 Required components:

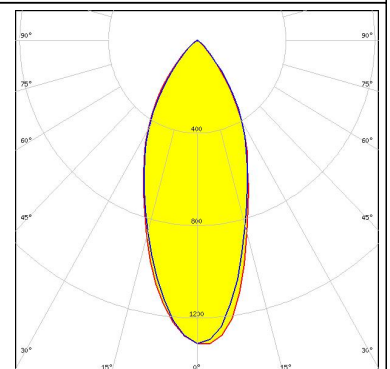
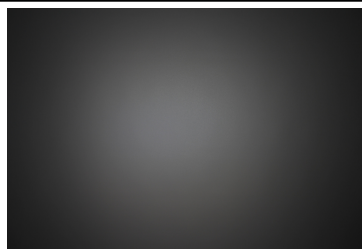

PHOTOMETRIC DATA (SIMULATED):

 **LUMILEDS**

LED LUXEON H50-2

FWHM 83.0°

Efficiency 93 %

Peak intensity 0.600 cd/lm

Required components:

GENERAL INFORMATION:

NOTE: The typical beam angle will be changed by different color, chip size and chip position tolerance. The typical total beam angle is the full angle measured where the luminous intensity is half of the peak value.

MATERIALS:

As part of our continuous research and improvement processes, and to ensure the best possible quality and availability of our products, LEDiL reserves the right to change material grades without notice.

PRODUCT DATA USER AGREEMENT AND DISCLAIMER:

The measured data in the provided downloadable LEDiL Product Datasheets and Mechanical 2D-Drawings is rounded and provided as reference for planning. LEDiL Oy's optical specifications have been verified by conducting performance testing of the products in accordance with the company's quality system. The reported data are averaged results of multiple measurements with typical variation. LEDiL Oy reserves the right to without prior notification make changes and improvements to its products.

LEDiL Oy assumes neither warranty, nor guarantee nor any other liability of any kind for the contents and correctness of the provided data. The provided data has been generated with highest diligence but the provided data may in reality not represent the complete possible variation range of all intrinsic parameters. Therefore, in certain cases a deviation from the provided data could occur.

LEDiL Oy reserves the right to undertake technical changes of its products without further notification which could lead to changes in the provided data. LEDiL Oy assumes no liability of any kind for the possible deviation from any provided data or any other damage resulting from the usage of the provided data.

The user agrees to this disclaimer and user agreement with the download or usage of the provided files.

LEDiL Oy

Joensuunkatu 13
FI-24240 SALO
Finland

LEDiL Inc.

228 West Page Street
Suite D
Sycamore IL 60178
USA

Local sales and technical support

[www.ledil.com/
where_to_buy](http://www.ledil.com/where_to_buy)

Shipping locations

Salo, Finland
Hong Kong, China

Distribution Partners

[www.ledil.com/
where_to_buy](http://www.ledil.com/where_to_buy)