

## 2.5A, 3MHz Switching Charger with Dynamic Power Path Management

### DESCRIPTION

ETA6003 is a switching Li-Ion battery charger with dynamic power-path control and input current limiting. When a battery is connected, depending on the battery voltage, the DC-DC switching regulator either pre-conditions, fast-charges the battery or just regulates a system voltage ( $V_{SYS}$ ) to a preset voltage. It does not require an external sense resistor for current sensing. The charging current is determined by programming ISET1 or ISET2 pin, depending on the state of the USB\_DET. If USB\_DET is low, indicating an valid AC adapter input is present, the charge current is set by ISET1; otherwise, it is set by ISET2. When the battery voltage reaches the termination voltage i.e. 4.2V, the charging path disconnects SYS to BATT. The ETA6003 also includes a dynamic power path when the SYS load current exceeds current limit of the DCDC regulator internally set, the SYS voltage falls below  $V_{BATT}$ , ETA6003 turns on the power-path to supplement the system load through the battery.

### FEATURES

- ◆ Switching Charger with Power Path Management
- ◆ Up to 95% DC-DC Efficiency
- ◆ 50mΩ Power Path MOSFET
- ◆ Up to 2.5A Max charging current
- ◆ Instant on with a dead Battery or no Battery
- ◆ No battery detection
- ◆ No External Sense resistor
- ◆ Programmable USB and AC IN Charging Current

### APPLICATIONS

- ◆ Tablet, MID
- ◆ Smart Phone
- ◆ Power Bank

### ORDERING INFORMATION

PART	PACKAGE PIN	TOP MARK
ETA6003Q3Q	QFN3X3-16	ETA-42 - Product Number YWWPL - Date Code

### TYPICAL APPLICATION

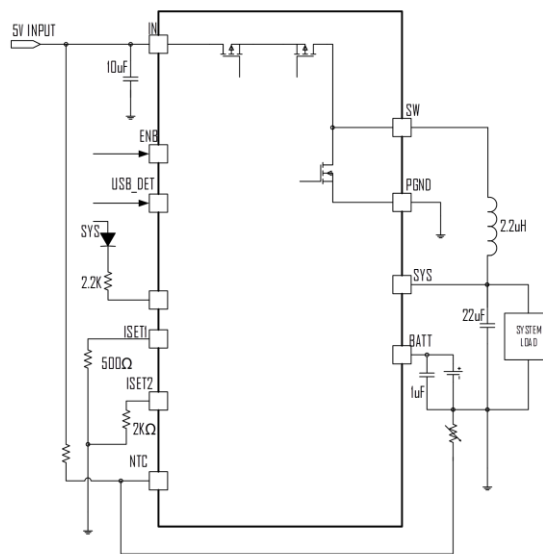

2A Switching Charger with Dynamic Power Pat

PIN CONFIGURATION

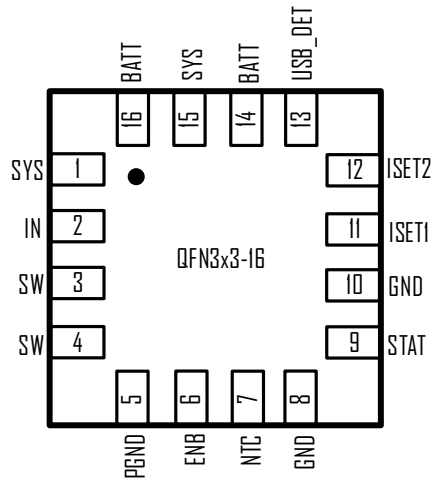

ABSOLUTE MAXIMUM RATINGS

(Note: Exceeding these limits may damage the device. Exposure to absolute maximum rating conditions for long periods may affect device reliability.)

- IN, BATT Voltage .....-0.3V to 6V
- All Other Pin Voltage .....VIN-0.3V to VIN+0.3
- SW, SYS, BATT to ground current.....Internally limited
- Operating Temperature Range .....-40°C to 85°
- Storage Temperature Range .....-55°C to 150°C
- Thermal Resistance  $\theta_{JA}$
- QFN3X3-16.....50 .....°C/W

ELECTRICAL CHARACTERISTICS

(VIN = 5V, unless otherwise specified. Typical values are at TA = 25°C.)

PARAMETER	CONDITIONS	MIN	TYP	MAX	UNITS
<b>IN INPUT</b>					
INPUT Range		4.4		5.5	V
INPUT UVLO	Rising, Hys=500mV		4.35		V
INPUT Operating Current	Switcher Enable, Switching		5		mA
	Switcher Enable, No Switching		70		µA
BATT to INPUT leakage Current	Input Floating		0	5	µA
<b>DC-DC and SYS OUTPUT</b>					
VSYSTEMIN	ISYS=1A, Default		3.6		V
VSYSTEMMAX			4.5		V
Load Regulation			40		mV/A
Line Regulation	VIN =4.75 to 5.25V		0.04		%/V
Switching Frequency			3		MHz
Max duty		100			%

PARAMETER	CONDITIONS	MIN	TYP	MAX	UNITS
HIGH SIDE MOS R <sub>DS(on)</sub>	I <sub>SW</sub> = 500mA		100		mΩ
LOW SIDE MOS R <sub>DS(on)</sub>	I <sub>SW</sub> = 500mA		60		mΩ
HIGH SIDE Current limit			3.5		A
SYS UVLO	Falling, Hys=200mV		2.25		V
Thermal Shutdown	Rising, Hys=30°C		160		°C
<b>POWER PATH Management</b>					
BATT TO SYS R <sub>DS(on)</sub>			50		mΩ
<b>BATTERY CHARGER</b>					
Battery CV voltage	I <sub>BAT</sub> = 0mA, default	4.16	4.2	4.24	V
Charger Restart Threshold	From DONE to FastCharge		-200		mV
Battery Pre-condition Voltage	V <sub>BAT</sub> Rising Hys=180mV		2.9		V
Pre-Condition Charge Current			100		mA
AC Fast Charge Current	R <sub>ISET1</sub> = 500Ω, USB_DET = low I <sub>charge</sub> = IV * 1000 / R <sub>ISET1</sub>		2		A
USB Charge Current	R <sub>ISET2</sub> = 2KΩ, USB_DET = high I <sub>charge</sub> = IV * 1000 / R <sub>ISET2</sub>		0.5		A
Pre-condition Timer			120		min
Fast-Charge Timer			960		min
<b>THERMISTOR MONITOR</b>					
NTC Threshold, Cold	Charger Suspended		76.5		%V <sub>IN</sub>
NTC Threshold, Hot	Charger Suspended		35		%V <sub>IN</sub>
NTC Threshold Hysteresis			1.5		%V <sub>IN</sub>
NTC Disable Threshold			100		mV
NTC Input Leakage			0		μA
<b>LOGIC INPUT, STATS</b>					
ENB Logic Input High		1.6			V
ENB Logic Input Low				0.3	V
STAT Output Low Voltage	I <sub>STATS</sub> = 10mA			0.2	V

## PIN DESCRIPTION

PIN #	NAME	DESCRIPTION
1,15	SYS	System Voltage Pin. It is also the Switching regulator's output pin. Connect an inductor and capacitor to form the output filter
2	IN	Input pin. Can be connected to an AC adaptor or a USB charger output. Bypass with a 10μF capacitor each to GND and PGND
3,4	SW	Switching node of the Switching Regulator. Connect a 1μH to 2.2μH inductor from this pin to SYS
5	PGND	Power Ground. Bypass with a 10μF capacitor to IN with a shortest possible trace
6	ENB	Active Low Enable pin. Tie this pin low to enable the Charging, tie high to disable Charging, while still keeping powerpath from BATT to SYS

7	NTC	Thermistor input
8,10	GND	Analog Ground Pin. Bypass with a 10 $\mu$ F capacitor to IN
9	STATS	Status pin for Charging status indications. An open drain device capable of driving 10mA current
11	ISET1	AC Fast Charge Current set pin for AC input. Connecting a Resistor between ISET1 to GND This sets the fast charge current value for AC adapter when USB_DET is low.
12	ISET2	USB Charge Current set pin for USB input. Connecting a Resistor between ISET2 to GND This sets the charge current value for USB input when USB_DET is high.
13	USB_DET	Charge current selecting input. Pull this pin low if an AC adapter is connected and select fast charging current to be set by ISET1. And set this pin high if a USB input is connected and select USB charging current to be set by ISET2. It is default low.
14,16	BATT	Battery pin. Connect a Battery to this pin

### TYPICAL CHARACTERISTICS

(Typical values are at T<sub>A</sub> = 25°C unless otherwise specified.)

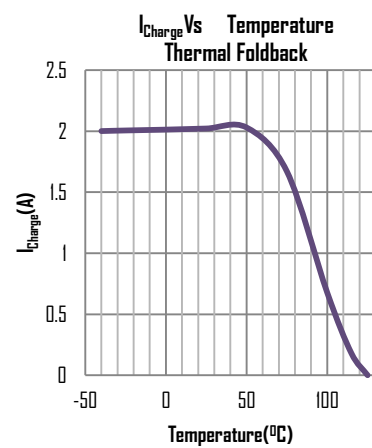
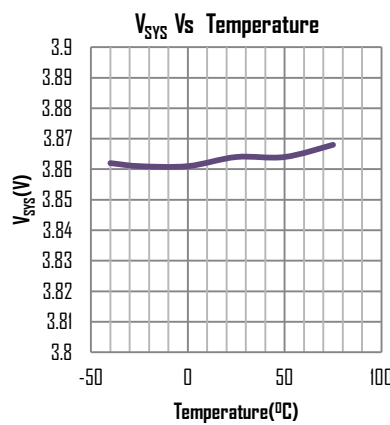
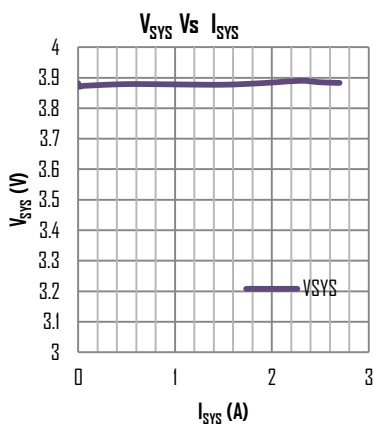
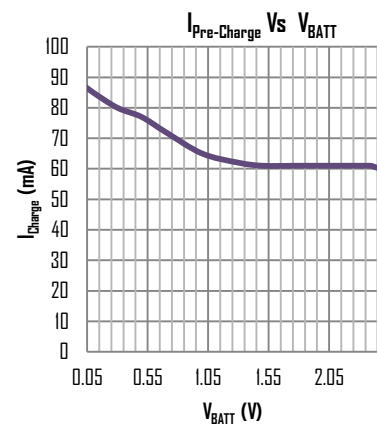
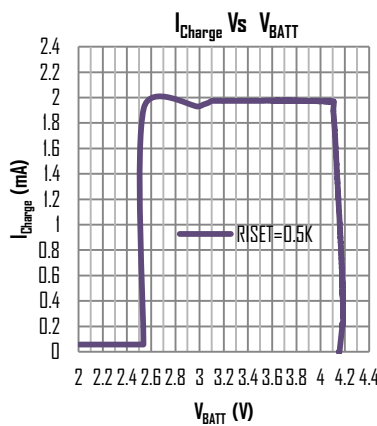
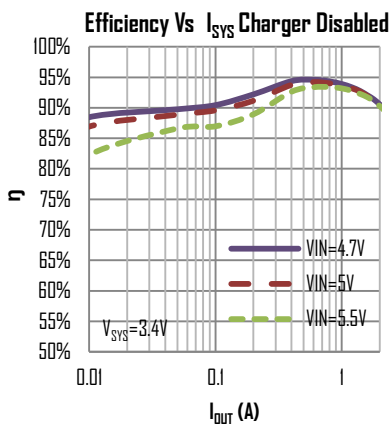

TYPICAL CHARACTERISTICS

(Typical values are at  $T_A = 25^\circ\text{C}$  unless otherwise specified.)

Battery Inserted During Detection

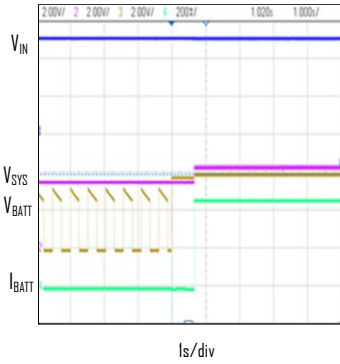

Battery Pulled During Charging

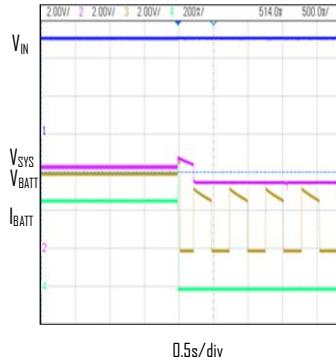

IN Plug-In with Battery Connected

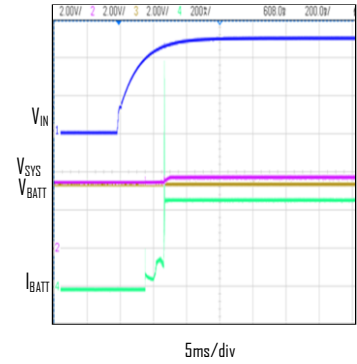

V<sub>sys</sub> Load Step Into Reduce Charging

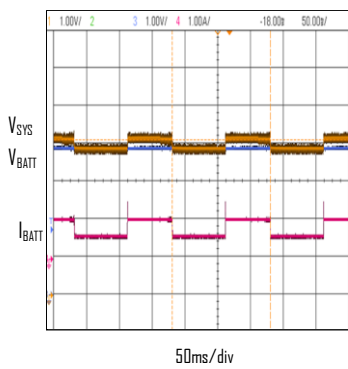

V<sub>sys</sub> Load Step Into Supplement Mode

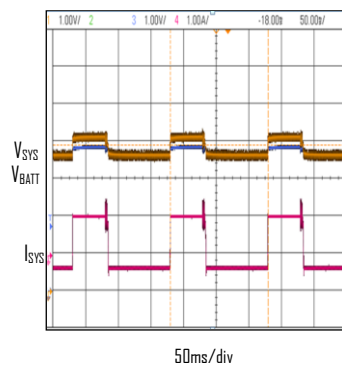

V<sub>sys</sub> Load Step Into IN DPPM Mode, I<sub>IN</sub> LIMIT=0.5A

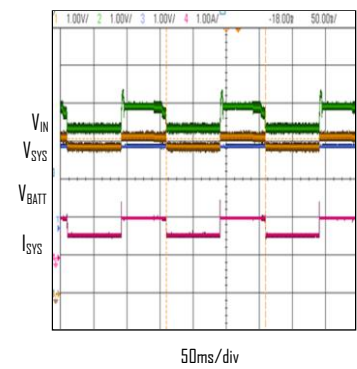

DCDC PFM SWITCHING WAVEFORM  
I<sub>sys</sub>=10mA

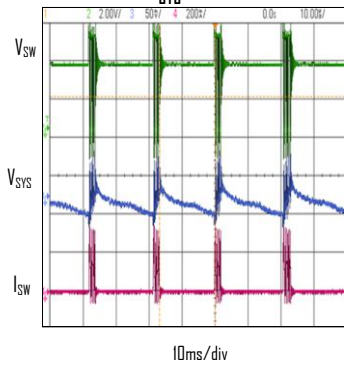

DCDC PWM SWITCHING WAVEFORM  
I<sub>sys</sub>=2A

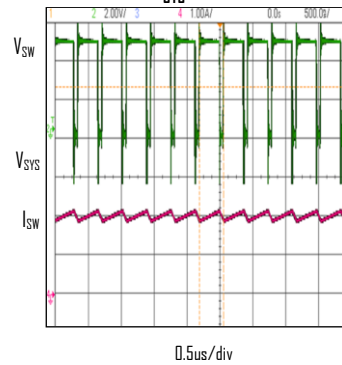

IN UNPLUGGED

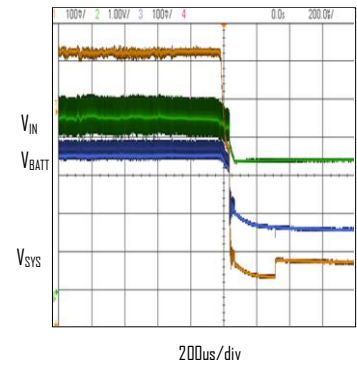

TYPICAL APPLICATION

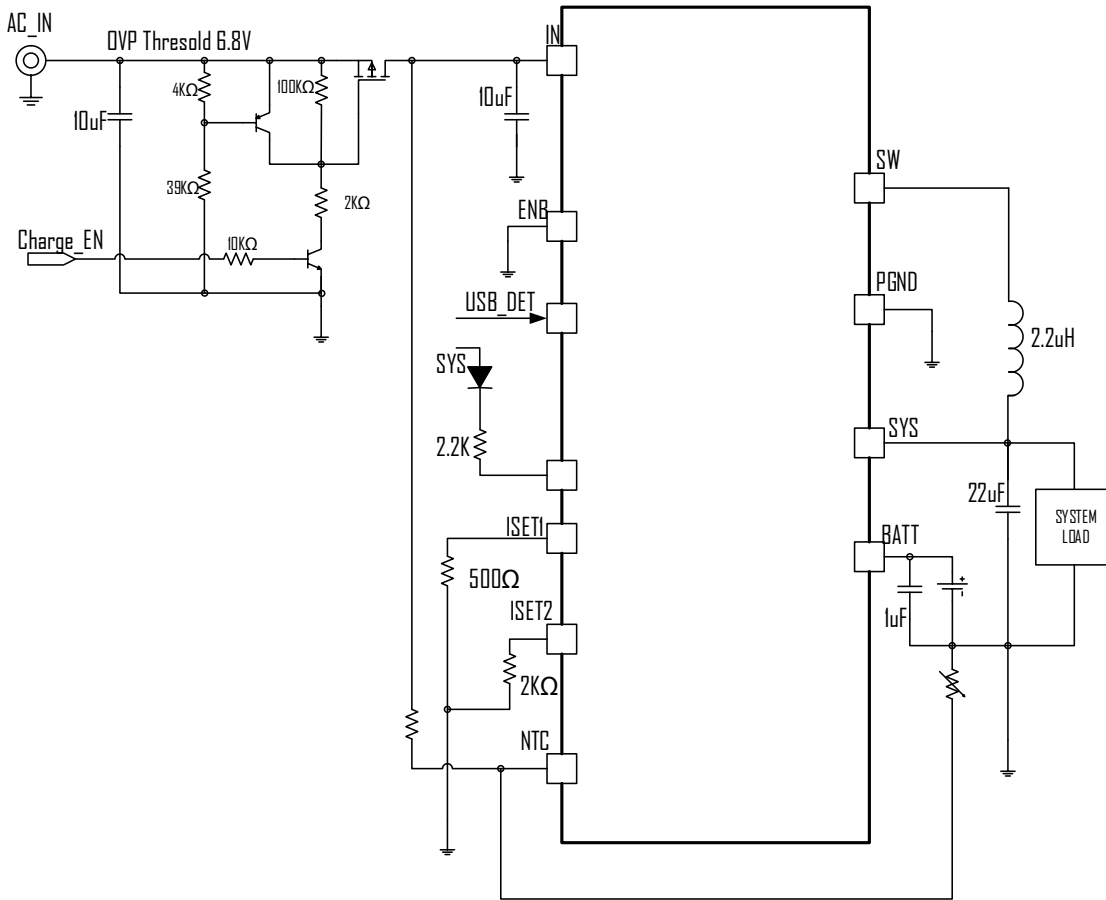

2A Switching Charger with Dynamic Power Path with VDP protection and Charge Enable

PCB GUIDELINE

PCB layout cautions of ETAG003 is shown below. The input capacitor (Cin) between Vin (Pin2) and PGND (Pin5) is always to be placed closest to the IC. SW wire can be laid through the gap between the 2 Cin terminals. It can go underneath the Cin. For all pins that needs to be shorted to GND, please connect them to GND (Pin10), not to PGND (Pin5). A real PCB layout example is also listed below for reference.

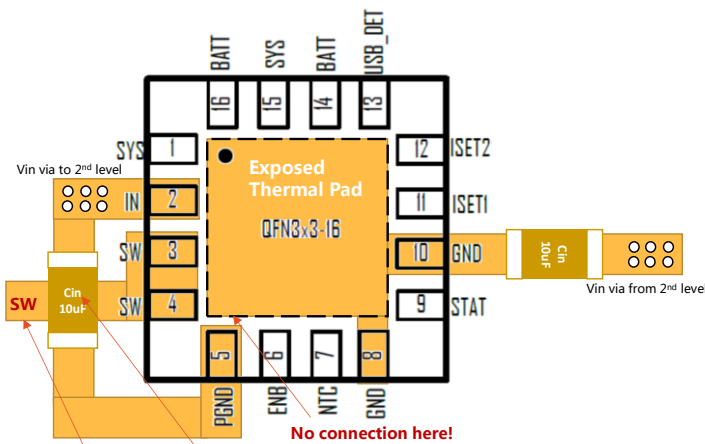

PCB cautions of ETAG003

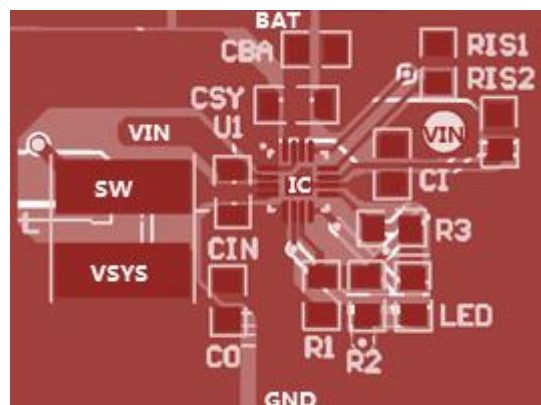

Real DEMO board PCB for reference

PACKAGE OUTLINE

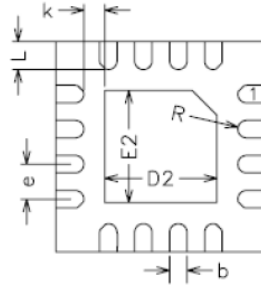
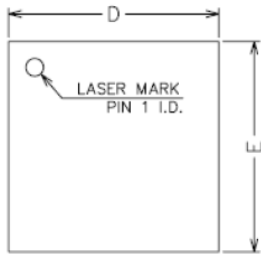

COMMON DIMENSIONS  
(UNITS OF MEASURE=MILLIMETER)

SYMBOL	MIN	NOM	MAX
A	0.70	0.75	0.80
A1	0	0.02	0.05
A3	0.20REF		
b	0.20	0.25	0.30
D	2.90	3.00	3.10
E	2.90	3.00	3.10
D2	1.55	1.65	1.75
E2	1.55	1.65	1.75
e	0.40	0.50	0.60
K	0.20	-	-
L	0.35	0.40	0.45
R	0.09	-	-

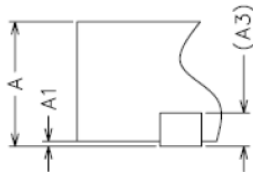

NOTE:  
ALL DIMENSIONS REFER TO JEDEC STANDRAD MO-220 WEED-4.