

# CoolMOS™<sup>1)</sup> Power MOSFET ISOPLUS™ Package

N-Channel Enhancement Mode  
Low  $R_{DS(on)}$ , high  $V_{DSS}$  MOSFET  
Electrically Isolated Back Surface

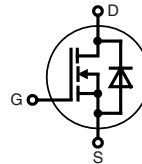

$$I_{D25} = 13 \text{ A}$$

$$V_{DSS} = 800 \text{ V}$$

$$R_{DS(on) \text{ max}} = 290 \text{ m}\Omega$$

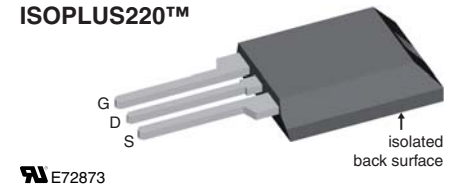
**ISOPLUS220™**

E72873

MOSFET			
Symbol	Conditions	Maximum Ratings	
$V_{DSS}$	$T_{VJ} = 25^\circ\text{C}$	800	V
$V_{GS}$		$\pm 20$	V
$I_{D25}$	$T_C = 25^\circ\text{C}$	13	A
$I_{D90}$	$T_C = 90^\circ\text{C}$	9	A
$E_{AS}$	$T_{J \text{ start}} = 25^\circ\text{C}$ ; single pulse; $I_D = 3.4 \text{ A}$	670	mJ
$E_{AR}$	$T_{J \text{ start}} = 25^\circ\text{C}$ ; repetitive; $I_D = 17 \text{ A}$	0.5	mJ
$dV/dt$	$V_{DS} < V_{DSS}$ ; $I_F = 17 \text{ A}$ ; $T_{VJ} = 150^\circ\text{C}$ $dI_R/dt = 100 \text{ A}/\mu\text{s}$	6	V/ns

### Features

- Silicon chip on Direct-Copper-Bond substrate
  - high power dissipation
  - isolated mounting surface
  - 2500 V electrical isolation
- 3<sup>rd</sup> generation CoolMOS™<sup>1)</sup> power MOSFET
  - high blocking capability
  - lowest resistance
  - avalanche rated for unclamped inductive switching (UIS)
- Low thermal resistance due to reduced chip thickness
- Low drain to tab capacitance (<30 pF)

### Applications

- Switched mode power supplies (SMPS)
- Uninterruptible power supplies (UPS)
- Power factor correction (PFC)
- Welding
- Inductive heating

### Advantages

- Easy assembly: no screws or isolation foils required
- Space savings
- High power density

<sup>1)</sup> CoolMOS™ is a trademark of Infineon Technologies AG.

Symbol	Conditions	Characteristic Values			
		(T <sub>VJ</sub> = 25°C, unless otherwise specified)			
		min.	typ.	max.	
$R_{DS(on)}$	$V_{GS} = 10 \text{ V}$ ; $I_D = I_{D90}$		250	290	mΩ
$V_{GS(th)}$	$V_{DS} = V_{GS}$ ; $I_D = 1 \text{ mA}$	2		4	V
$I_{DSS}$	$V_{DS} = V_{DSS}$ ; $V_{GS} = 0 \text{ V}$			25	μA
			125		μA
$I_{GSS}$	$V_{GS} = \pm 20 \text{ V}$ ; $V_{DS} = 0 \text{ V}$			$\pm 100$	nA
$C_{iss}$	$V_{GS} = 0 \text{ V}$ ; $V_{DS} = 25 \text{ V}$ ; $f = 1 \text{ MHz}$		2300		pF
$C_{oss}$			1250		pF
$C_{rss}$			60		pF
$Q_g$	$V_{GS} = 0 \text{ to } 10 \text{ V}$ ; $V_{DS} = 640 \text{ V}$ ; $I_D = I_{D90}$		90		nC
$Q_{gs}$			10		nC
$Q_{gd}$			40		nC
$t_{d(on)}$	$V_{GS} = 10 \text{ V}$ ; $V_{DS} = 640 \text{ V}$ ; $T_{VJ} = 125^\circ\text{C}$ $I_D = 17 \text{ A}$ ; $R_G = 4.7 \Omega$		25		ns
$t_r$			25		ns
$t_{d(off)}$			75		ns
$t_f$			10		ns
$R_{thJC}$			1.0		K/W

**Source-Drain Diode**

Symbol	Conditions	Characteristic Values			
		min.	typ.	max.	
( $T_{VJ} = 25^{\circ}\text{C}$ , unless otherwise specified)					
$I_S$	$V_{GS} = 0\text{ V}$			17	A
$V_{SD}$	$I_F = 17\text{ A}; V_{GS} = 0\text{ V}$		1.0	1.2	V
$t_{rr}$	} $I_F = 17\text{ A}; -di_F/dt = 100\text{ A}/\mu\text{s}; V_R = 400\text{ V}$		550		ns
$Q_{RM}$			15		$\mu\text{C}$
$I_{RM}$			50		A

**Component**

Symbol	Conditions	Maximum Ratings	
$T_{VJ}$	operating	-55...+150	$^{\circ}\text{C}$
$T_{stg}$		-55...+150	$^{\circ}\text{C}$
$V_{ISOL}$	RMS, lead-to-tab, 50/60 Hz, $f = 1$ minute	2500	V~
$F_C$	mounting force	11-65/2.4-11	N/lb.

Symbol	Conditions	Characteristic Values		
		min.	typ.	max.
$R_{thCH}$	with heatsink compound		0.3	K/W
Weight			2.7	g

**ISOPLUS220™ Outline**

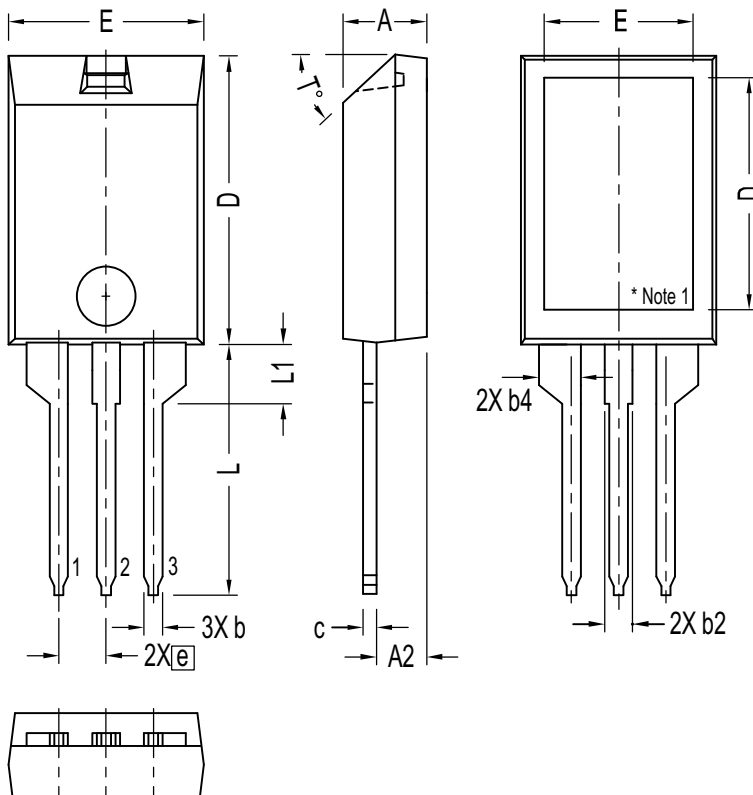
SYM	INCHES		MILLIMETERS	
	MIN	MAX	MIN	MAX
A	.157	.197	4.00	5.00
A2	.098	.118	2.50	3.00
b	.035	.051	0.90	1.30
b2	.049	.065	1.25	1.65
b4	.093	.100	2.35	2.55
c	.028	.039	0.70	1.00
D	.591	.630	15.00	16.00
D1	.472	.512	12.00	13.00
E	.394	.433	10.00	11.00
E1	.295	.335	7.50	8.50
e	.100 BASIC		2.55	BASIC
L	.512	.571	13.00	14.50
L1	.118	.138	3.00	3.50
T°			42.5°	47.5°

**NOTE:**

- Bottom heatsink is electrically isolated from Pin 1, 2, or 3.
- This drawing will meet dimensional requirement of JEDEC SS Product Outline TO-273 except D and D1 dimension.

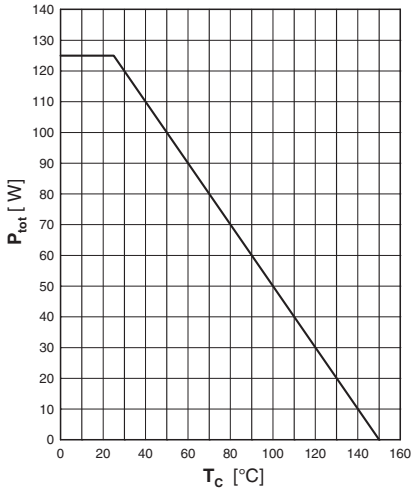

Fig. 1 Power Dissipation

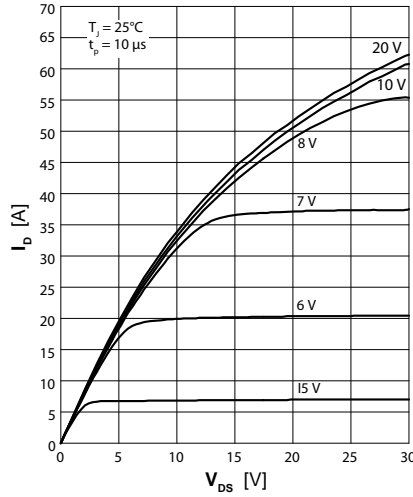

Fig. 2 Typ. Output Characteristics

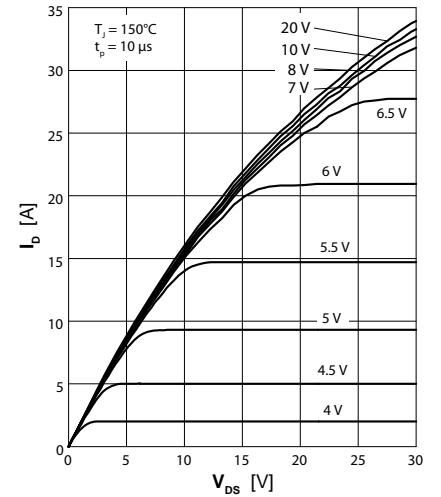

Fig. 3 Typ. Output Characteristics

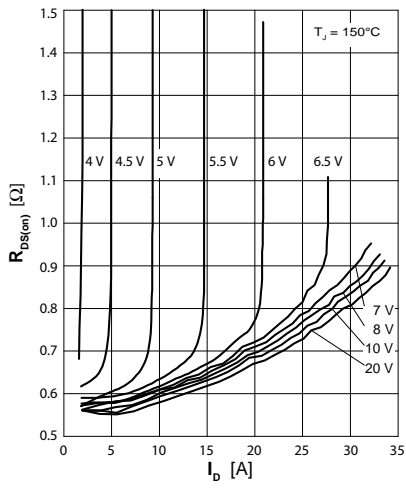

Fig. 4 Typ. Drain-Source on Resistance

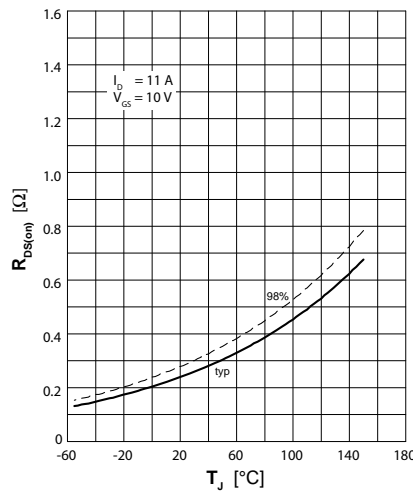

Fig. 5 Drain-Source On-State Resistance

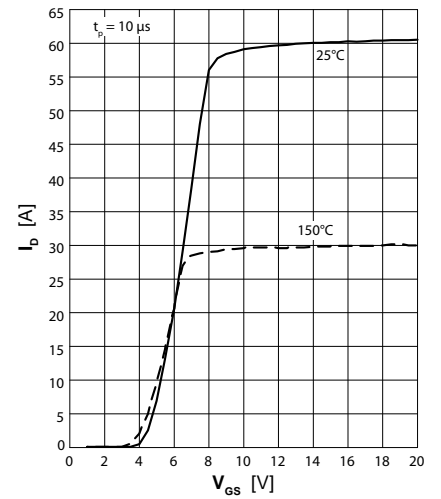

Fig. 6 Typ. Transfer Characteristics

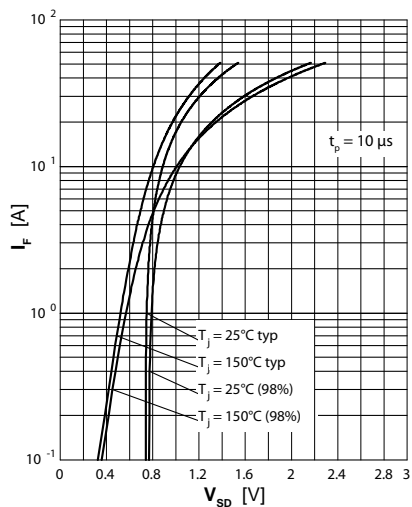

Fig. 7 Forward Characteristics of Body Diode

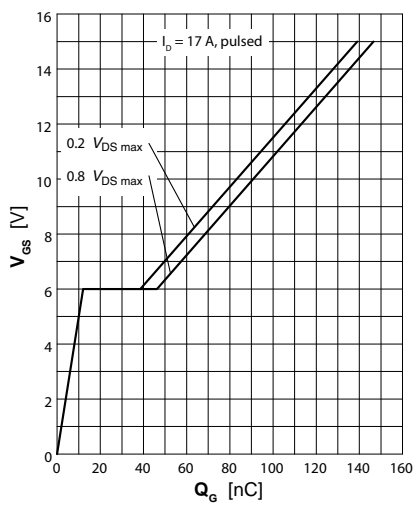

Fig. 8 Typ. Gate Charge

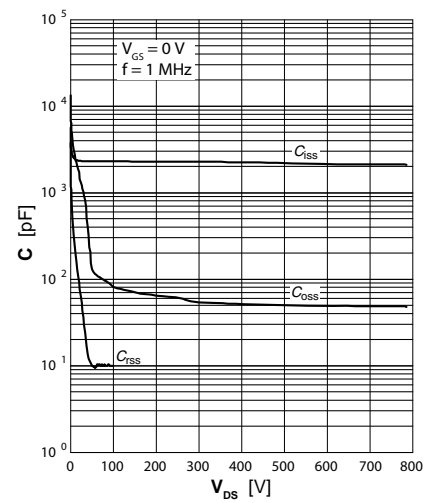

Fig. 9 Capacitance

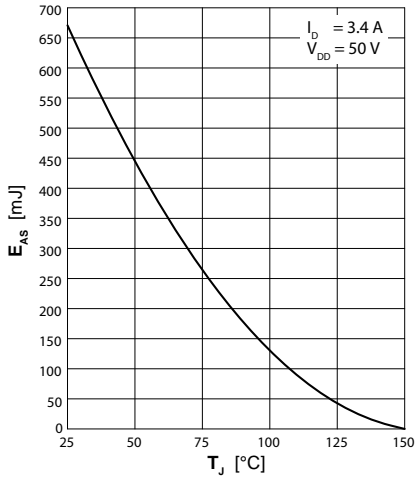

Fig. 10 Typ. Avalanche Energy

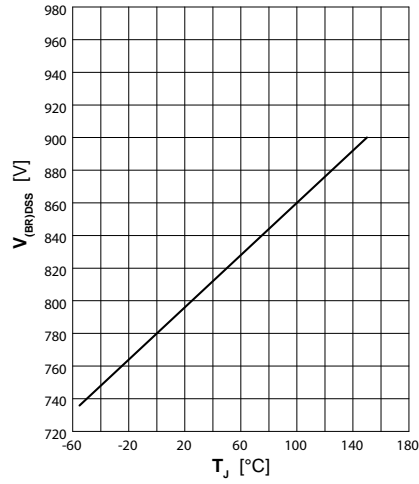

Fig. 11 Drain-Source Breakdown Voltage