

**SERIES:** SJ2-255X-SMT | **DESCRIPTION:** AUDIO JACK

**FEATURES**

- 5 conductor
- low profile design
- reflow solder compatible
- surface mount



**PART NUMBER KEY**

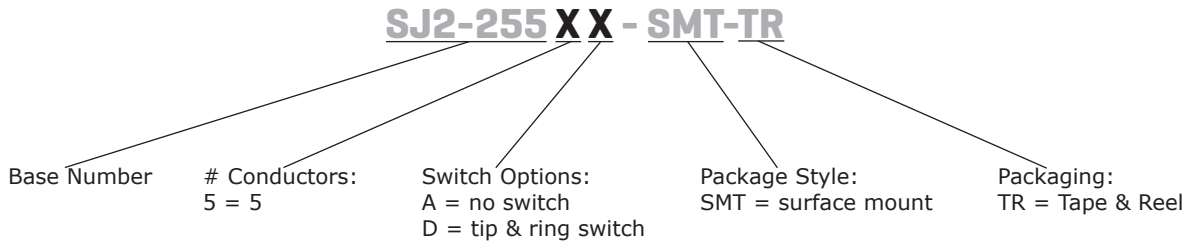

**SPECIFICATIONS**

parameter	conditions/description	min	typ	max	units
rated input voltage			12		Vdc
rated input current				1	A
contact resistance <sup>1</sup>	between terminal and mating plug between terminal in a closed circuit			50 30	mΩ mΩ
insulation resistance	at 500 Vdc	100			MΩ
voltage withstand	for 1 minute			500	Vac
insertion/withdrawal force		0.3		3	kg
operating temperature		-25		85	°C
life	at a rate of 24 cycles/minute		5,000		cycles
flammability rating	UL94V-0				
RoHS	2011/65/EU				

Note: 1. When measured at a current of less than 100 mA/1 kHz  
 2. All specifications measured at 10~35°C, humidity at 45~85%, under standard atmospheric pressure, unless otherwise noted.

## MECHANICAL DRAWING

units: mm  
 tolerance:  
 X.X ±0.2 mm  
 X.XX ±0.10 mm  
 X.XXX ±0.050 mm  
 PCB: ±0.05 mm

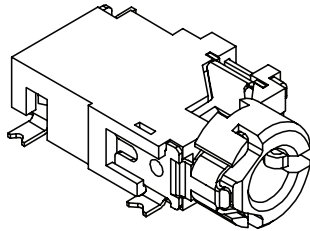

	MATERIAL	PLATING
terminal 1	copper alloy	silver
terminal 2	copper alloy	silver
terminal 3	copper alloy	silver
terminal 4	copper alloy	silver
terminal 5	copper alloy	silver
terminal 10	brass	silver
terminal 11	brass	silver
plastic	PA10T	

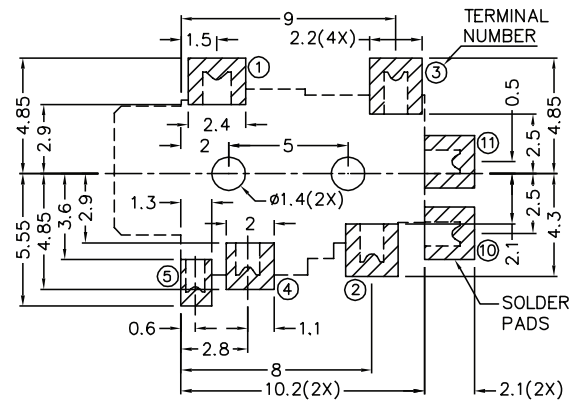
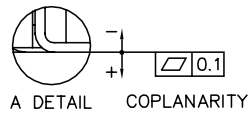
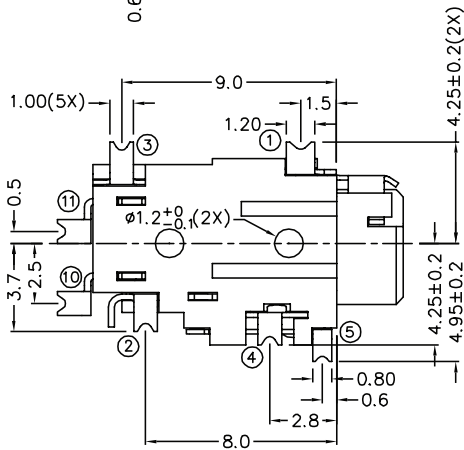
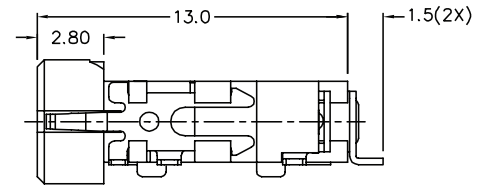
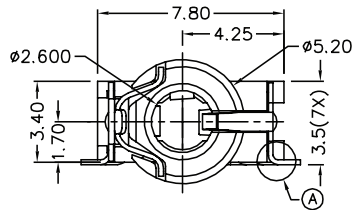
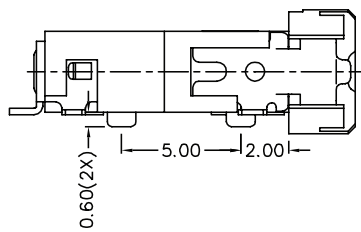

Recommended PCB Layout  
Top View

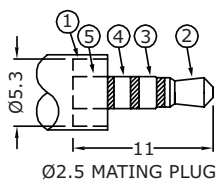

Model No.	SJ2-2555A-SMT	SJ2-2555D-SMT
Schematic		
PIN		
1	outer ring	outer ring
2	tip	tip
3	ring 1	ring 1
4	ring 2	ring 2
5	sleeve	sleeve
10	NP	tip switch
11	NP	ring 1 switch



## REVISION HISTORY

---

rev.	description	date
1.0	initial release	12/09/2016

The revision history provided is for informational purposes only and is believed to be accurate.



**Headquarters**  
20050 SW 112th Ave.  
Tualatin, OR 97062  
**800.275.4899**

Fax 503.612.2383  
**cui.com**  
techsupport@cui.com

CUI offers a one (1) year limited warranty. Complete warranty information is listed on our website.

CUI reserves the right to make changes to the product at any time without notice. Information provided by CUI is believed to be accurate and reliable. However, no responsibility is assumed by CUI for its use, nor for any infringements of patents or other rights of third parties which may result from its use.

CUI products are not authorized or warranted for use as critical components in equipment that requires an extremely high level of reliability. A critical component is any component of a life support device or system whose failure to perform can be reasonably expected to cause the failure of the life support device or system, or to affect its safety or effectiveness.