

Low Noise Silicon Bipolar RF Transistor

- For low current applications
- For oscillators up to 12 GHz
- Minimum noise figure $NF_{\min} = 1.25$ dB at 1.8 GHz
Outstanding $G_{ms} = 23$ dB at 1.8 GHz
- Pb-free (RoHS compliant) and halogen-free package with visible leads
- Qualification report according to AEC-Q101 available

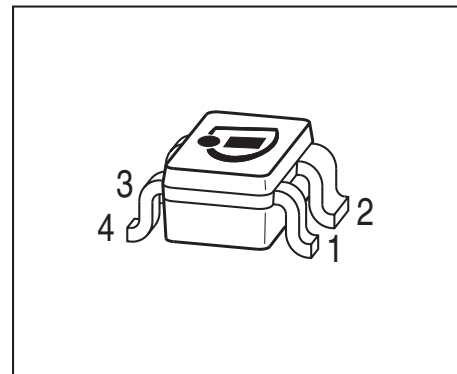

ESD (Electrostatic discharge) sensitive device, observe handling precaution!

Type	Marking	Pin Configuration						Package
BFP405	ALs	1=B	2=E	3=C	4=E	-	-	SOT343

Maximum Ratings at $T_A = 25$ °C, unless otherwise specified

Parameter	Symbol	Value	Unit
Collector-emitter voltage $T_A = 25$ °C $T_A = -55$ °C	V_{CEO}	4.5 4.1	V
Collector-emitter voltage	V_{CES}	15	
Collector-base voltage	V_{CBO}	15	
Emitter-base voltage	V_{EBO}	1.5	
Collector current	I_C	25	mA
Base current	I_B	3	
Total power dissipation ¹⁾ $T_S \leq 110$ °C	P_{tot}	75	mW
Junction temperature	T_J	150	°C
Ambient temperature	T_A	-65 ... 150	
Storage temperature	T_{Stg}	-65 ... 150	

¹⁾ T_S is measured on the emitter lead at the soldering point to the pcb

Thermal Resistance

Parameter	Symbol	Value	Unit
Junction - soldering point ¹⁾	R_{thJS}	530	K/W

Electrical Characteristics at $T_A = 25\text{ °C}$, unless otherwise specified

Parameter	Symbol	Values			Unit
		min.	typ.	max.	

DC Characteristics

Collector-emitter breakdown voltage $I_C = 1\text{ mA}$, $I_B = 0$	$V_{(BR)CEO}$	4.5	5	-	V
Collector-emitter cutoff current $V_{CE} = 15\text{ V}$, $V_{BE} = 0$	I_{CES}	-	-	10	μA
Collector-base cutoff current $V_{CB} = 5\text{ V}$, $I_E = 0$	I_{CBO}	-	-	100	nA
Emitter-base cutoff current $V_{EB} = 0.5\text{ V}$, $I_C = 0$	I_{EBO}	-	-	1	μA
DC current gain $I_C = 5\text{ mA}$, $V_{CE} = 4\text{ V}$, pulse measured	h_{FE}	60	95	130	-

¹⁾For the definition of R_{thJS} please refer to Application Note AN077 (Thermal Resistance Calculation)

Electrical Characteristics at $T_A = 25\text{ }^\circ\text{C}$, unless otherwise specified

Parameter	Symbol	Values			Unit
		min.	typ.	max.	
AC Characteristics (verified by random sampling)					
Transition frequency $I_C = 10\text{ mA}$, $V_{CE} = 3\text{ V}$, $f = 2\text{ GHz}$	f_T	18	25	-	GHz
Collector-base capacitance $V_{CB} = 2\text{ V}$, $f = 1\text{ MHz}$, $V_{BE} = 0$, emitter grounded	C_{cb}	-	0.05	0.1	pF
Collector emitter capacitance $V_{CE} = 2\text{ V}$, $f = 1\text{ MHz}$, $V_{BE} = 0$, base grounded	C_{ce}	-	0.24	-	
Emitter-base capacitance $V_{EB} = 0.5\text{ V}$, $f = 1\text{ MHz}$, $V_{CB} = 0$, collector grounded	C_{eb}	-	0.29	-	
Minimum noise figure $I_C = 2\text{ mA}$, $V_{CE} = 2\text{ V}$, $f = 1.8\text{ GHz}$, $Z_S = Z_{Sopt}$	NF_{min}	-	1.25	-	dB
Power gain, maximum stable ¹⁾ $I_C = 5\text{ mA}$, $V_{CE} = 2\text{ V}$, $Z_S = Z_{Sopt}$, $Z_L = Z_{Lopt}$, $f = 1.8\text{ GHz}$	G_{ms}	-	23	-	dB
Insertion power gain $V_{CE} = 2\text{ V}$, $I_C = 5\text{ mA}$, $f = 1.8\text{ GHz}$, $Z_S = Z_L = 50\text{ }\Omega$	$ S_{21} ^2$	14	18.5	-	
Third order intercept point at output ²⁾ $V_{CE} = 2\text{ V}$, $I_C = 5\text{ mA}$, $f = 1.8\text{ GHz}$, $Z_S = Z_L = 50\text{ }\Omega$	$IP3$	-	15	-	dBm
1dB compression point at output $I_C = 5\text{ mA}$, $V_{CE} = 2\text{ V}$, $Z_S = Z_L = 50\text{ }\Omega$, $f = 1.8\text{ GHz}$	P_{-1dB}	-	5	-	

¹⁾ $G_{ms} = |S_{21} / S_{12}|$

²⁾IP3 value depends on termination of all intermodulation frequency components.
Termination used for this measurement is 50 Ω from 0.1 MHz to 6 GHz

Total power dissipation $P_{tot} = f(T_S)$

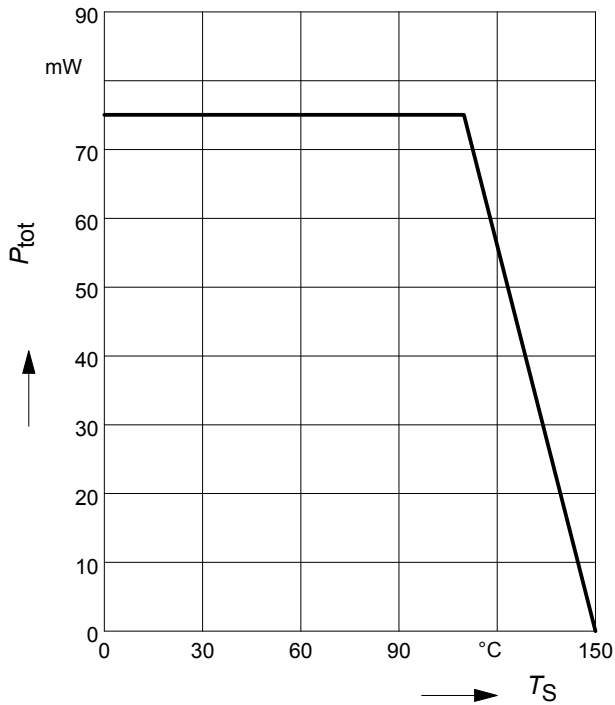

Permissible Pulse Load $R_{thJS} = f(t_p)$

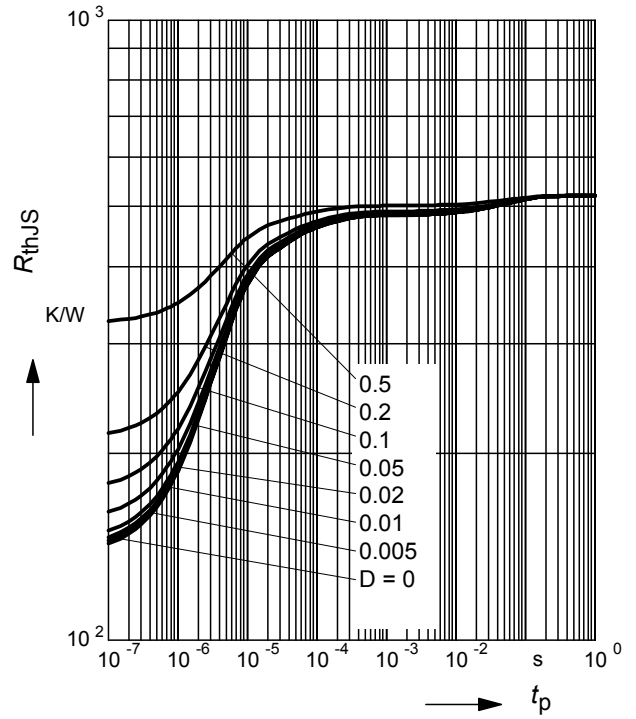

Permissible Pulse Load

$P_{totmax}/P_{totDC} = f(t_p)$

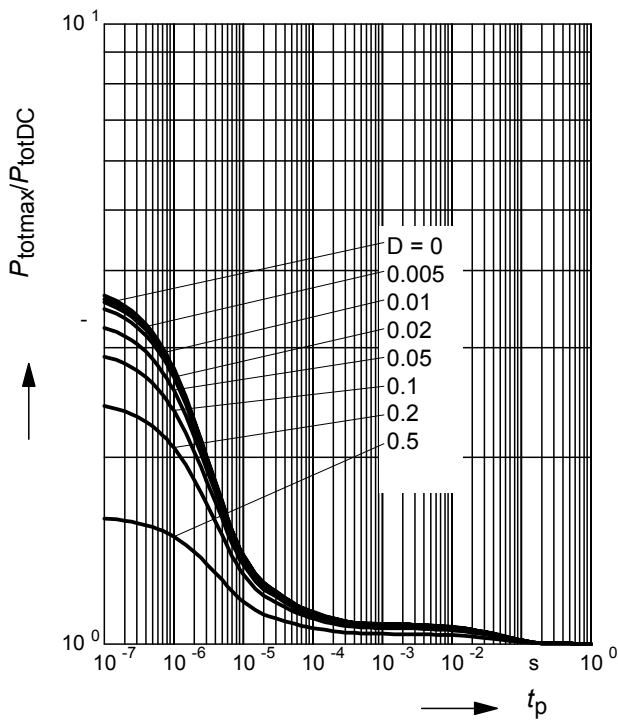

Collector-base capacitance $C_{cb} = f(V_{CB})$

$f = 1\text{MHz}$

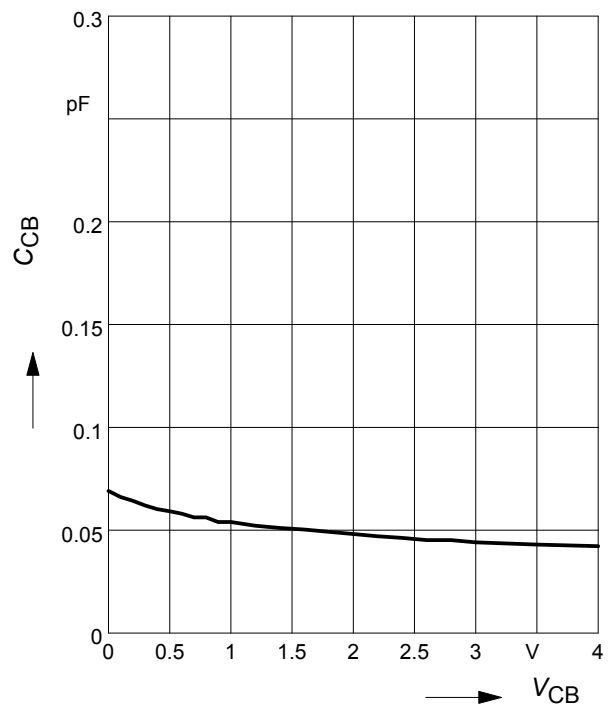

Transition frequency $f_T = f(I_C)$

$f = 2 \text{ GHz}$

$V_{CE} = \text{parameter in V}$

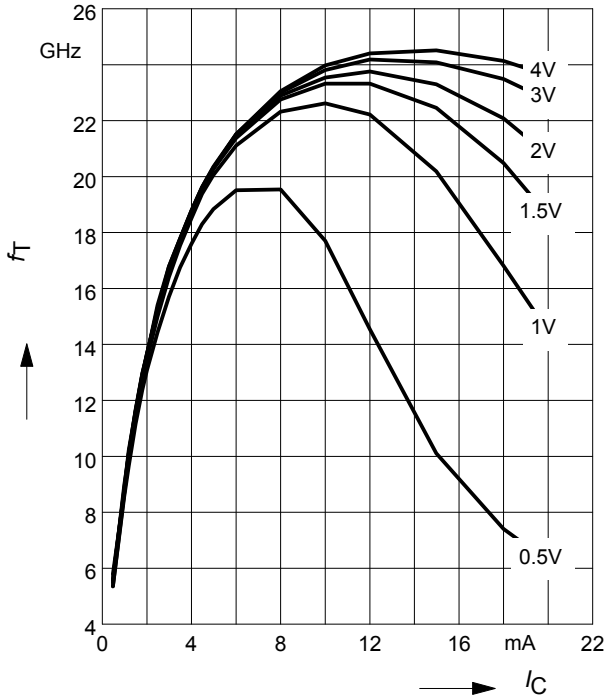

Power gain $G_{ma}, G_{ms}, |S_{21}|^2 = f(f)$

$V_{CE} = 3 \text{ V}, I_C = 5 \text{ mA}$

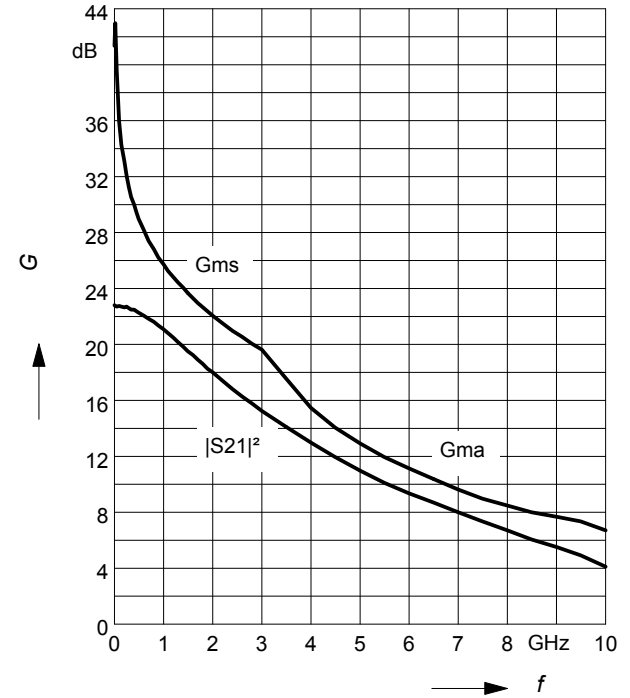

Power gain $G_{ma}, G_{ms} = f(I_C)$

$V_{CE} = 3 \text{ V}$

$f = \text{parameter in GHz}$

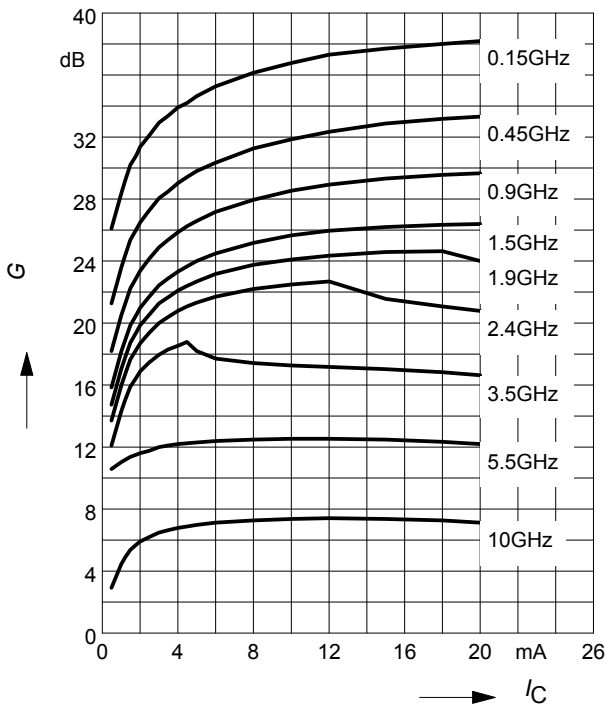

Power gain $G_{ma}, G_{ms} = f(V_{CE})$

$I_C = 5 \text{ mA}$

$f = \text{parameter in GHz}$

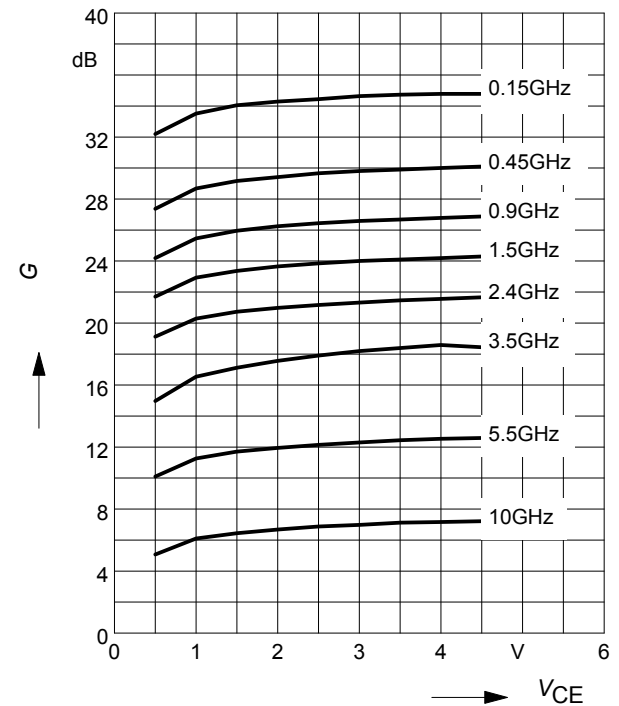

Noise figure $F = f(I_C)$

$V_{CE} = 2\text{ V}$, $Z_S = Z_{Sopt}$

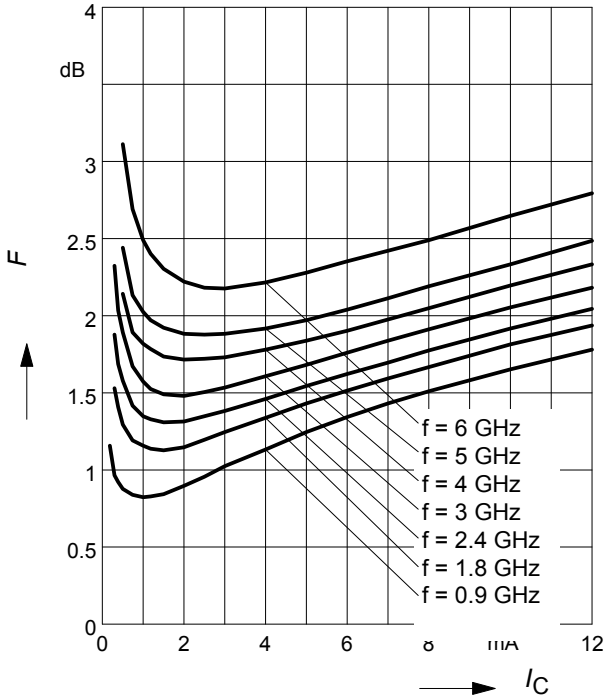

Noise figure $F = f(I_C)$

$V_{CE} = 2\text{ V}$, $f = 1.8\text{ GHz}$

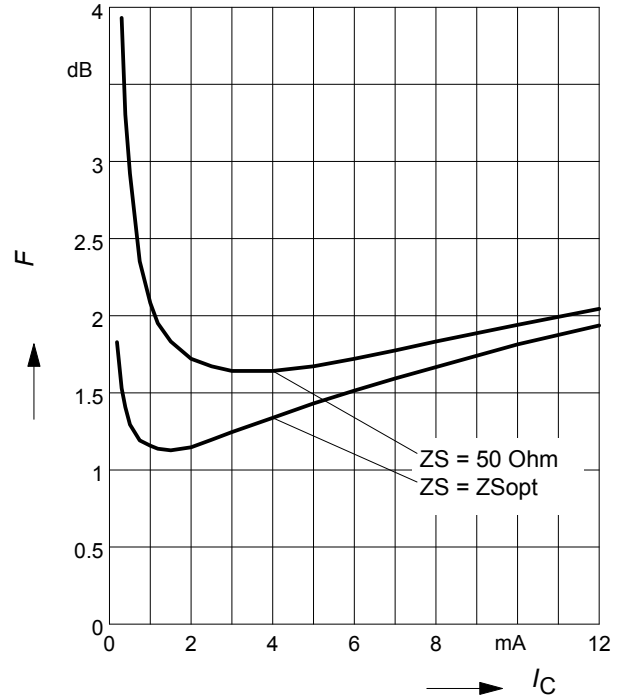

Noise figure $F = f(f)$

$V_{CE} = 1\text{ V}$, $Z_S = Z_{Sopt}$

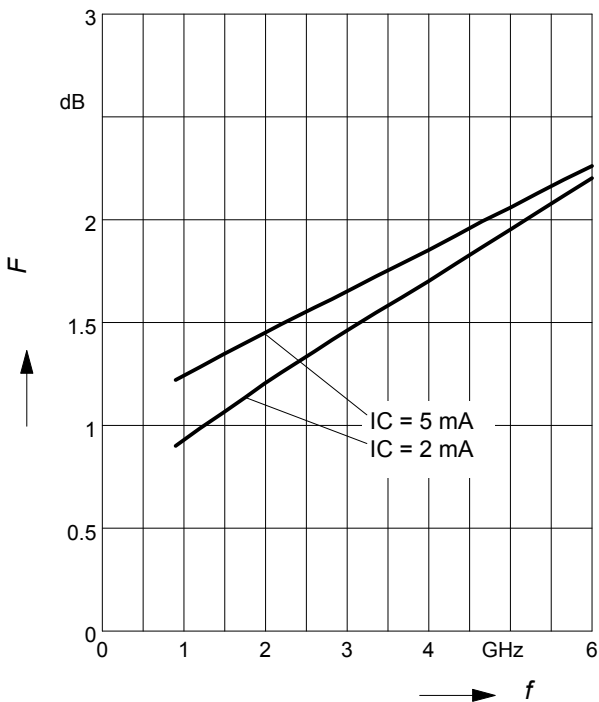

Source impedance for min.

noise figure vs. frequency

$V_{CE} = 3\text{ V}$, $I_C = 2\text{ mA} / 5\text{ mA}$

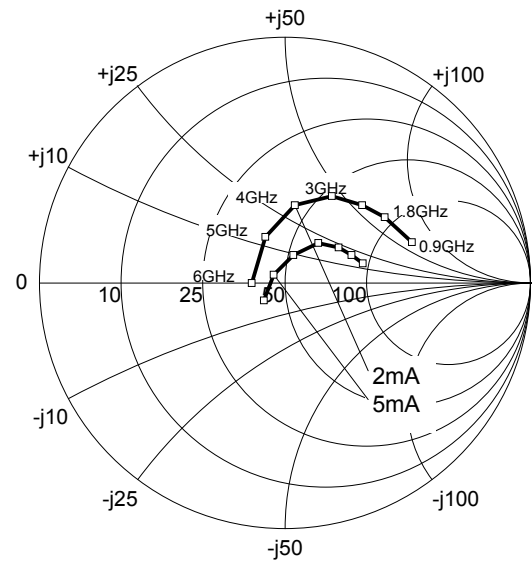

SPICE GP Model

For the SPICE Gummel Poon (GP) model as well as for the S-parameters (including noise parameters) please refer to our internet website www.infineon.com/rf.models.

Please consult our website and download the latest versions before actually starting your design. You find the BFP405 SPICE GP model in the internet in MWO- and ADS-format, which you can import into these circuit simulation tools very quickly and conveniently. The model already contains the package parasitics and is ready to use for DC and high frequency simulations. The terminals of the model circuit correspond to the pin configuration of the device. The model parameters have been extracted and verified up to 6 GHz using typical devices. The BFP405 SPICE GP model reflects the typical DC- and RF-performance within the limitations which are given by the SPICE GP model itself. Besides the DC characteristics all S-parameters in magnitude and phase, as well as noise figure (including optimum source impedance, equivalent noise resistance and flicker noise) and intermodulation have been extracted.

Package Outline

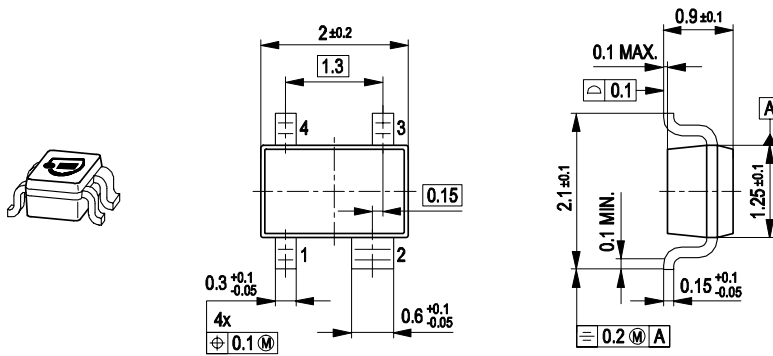

Foot Print

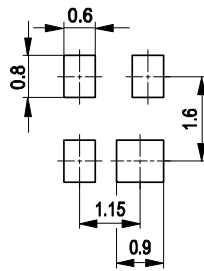

Marking Layout (Example)

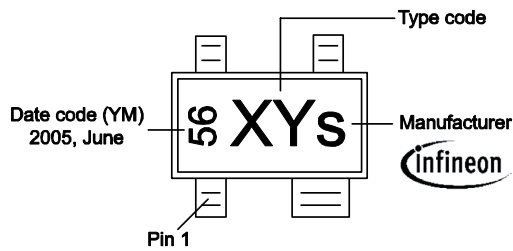

Standard Packing

Reel ø180 mm = 3.000 Pieces/Reel
 Reel ø330 mm = 10.000 Pieces/Reel

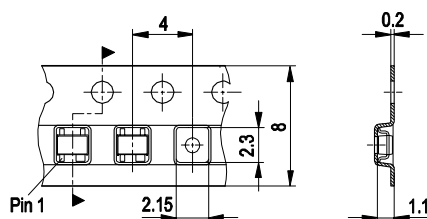

Edition 2009-11-05

**Published by Infineon Technologies AG,
85579 Neubiberg, Germany**

© Infineon Technologies AG 2009.

All Rights Reserved.

Attention please!

The information herein is given to describe certain components and shall not be considered as a guarantee of characteristics.

Terms of delivery and rights to technical change reserved.

We hereby disclaim any and all warranties, including but not limited to warranties of non-infringement, regarding circuits, descriptions and charts stated herein.

Information

For further information on technology, delivery terms and conditions and prices please contact your nearest Infineon Technologies Office (www.infineon.com).

Warnings

Due to technical requirements components may contain dangerous substances. For information on the types in question please contact your nearest Infineon Technologies Office.

Infineon Technologies Components may only be used in life-support devices or systems with the express written approval of Infineon Technologies, if a failure of such components can reasonably be expected to cause the failure of that life-support device or system, or to affect the safety or effectiveness of that device or system.

Life support devices or systems are intended to be implanted in the human body, or to support and/or maintain and sustain and/or protect human life. If they fail, it is reasonable to assume that the health of the user or other persons may be endangered.